



www.flitetest.com

FT Mini Commuter

Designed By: Ben Harber
Drawing By: Dan Sponholz
Version: 1.0
Date: 2019.06.30



GENERAL SPECIFICATIONS:

LENGTH:	23.00 in		584 mm
CG:	1.00 in		25.4 mm
WINGSPAN:	30.00 in		762 mm
WING AREA:	142.0 in ²		9.2 dm ²
DRY WEIGHT:	8.3 oz.		234 g
ALL UP WEIGHT:	10.0 oz.		284 g
WING LOADING:	10.1 oz/ft ²		31 g/dm ²
WCL:	10.2		
THROWS:	12°		
EXPO:	30%		
CHANNELS:	3-4 [THR AIL ELE RUD]		

RECOMMENDED ELECTRONICS:

MOTOR:	1806 2280 kv
PROPELLER:	6x3
ESC:	20a min.
SERVOS:	3-4X 5 g
BATTERY:	650-950 mAh 2S



BUILD SKILL LEVEL:



PILOT SKILL LEVEL:





FT Mini Commuter: Full-Size Key

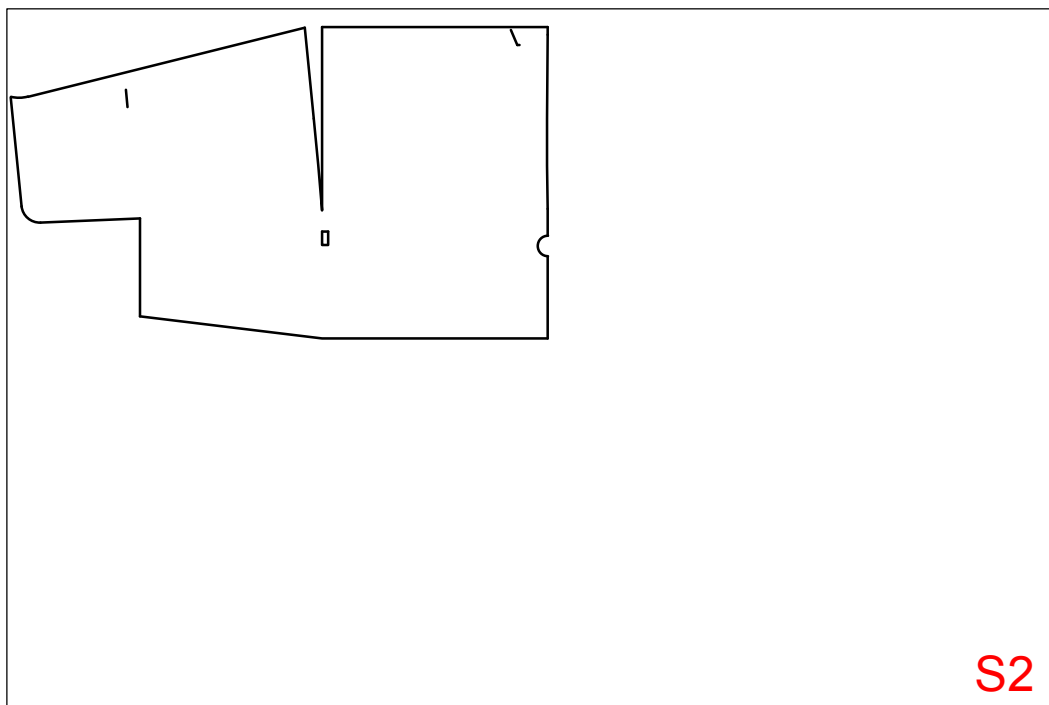
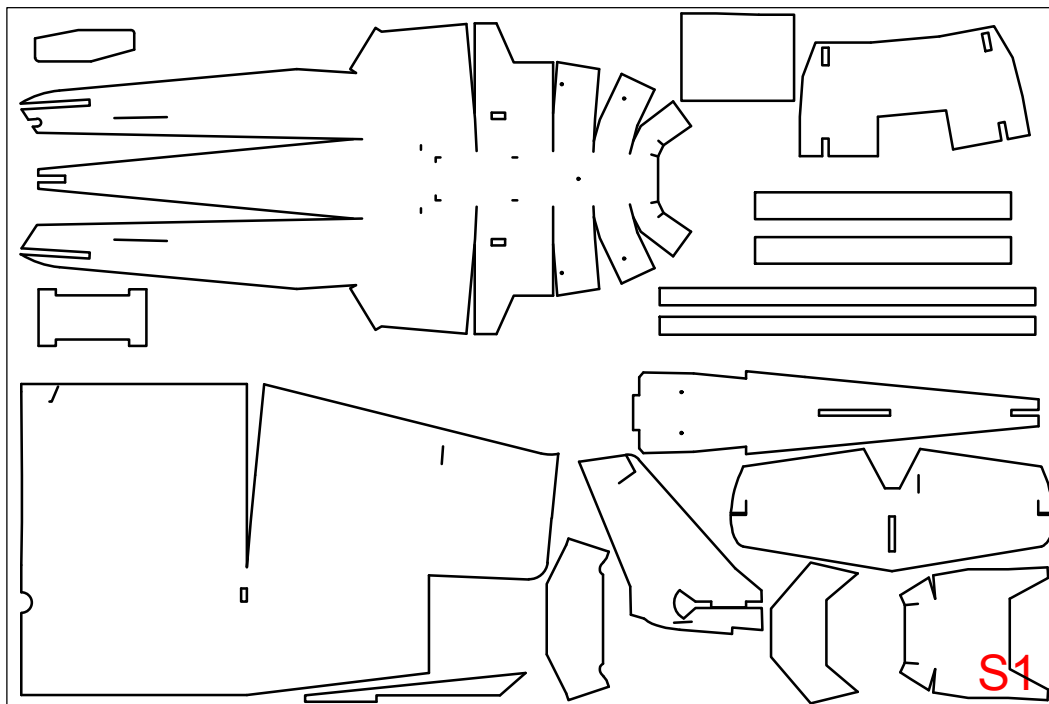



Drawing Key



FOLD TYPES

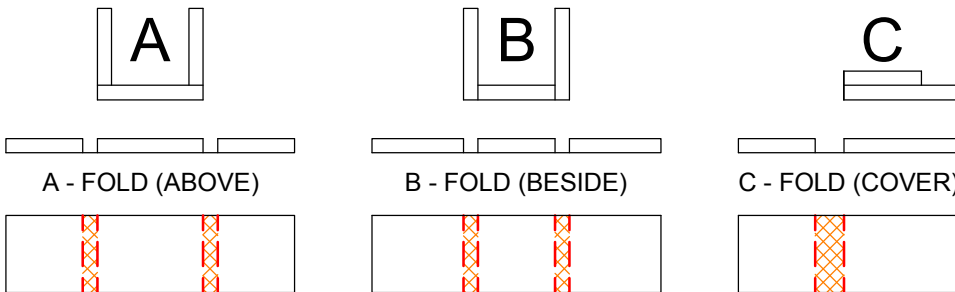

LINE TYPE/COLOR

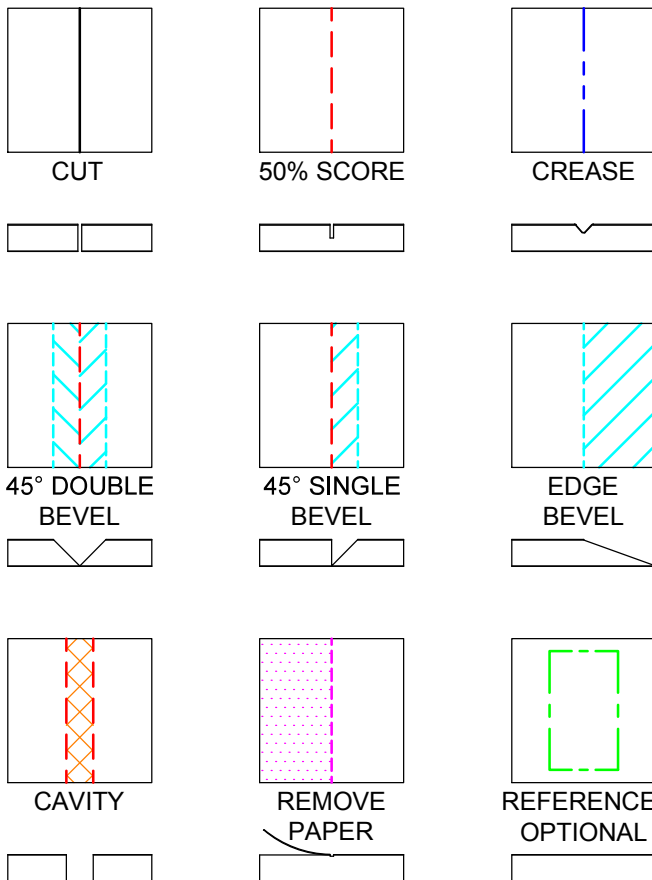

SYMBOLS

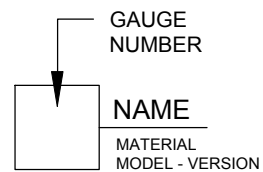
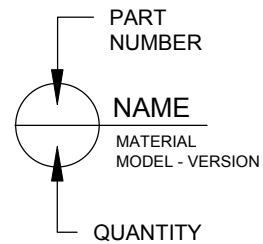

CENTER OF GRAVITY (CG)



FT Mini Commuter: Wood Parts



HOBBY GRADE PLYWOOD
1/16" (1.6 mm) THICK

FT MINI FIREWALL

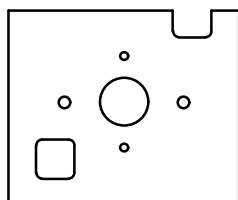

FT MINI CONTROL HORNS

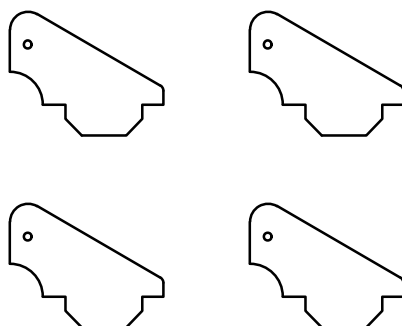

FT Mini Commut

Designed By: Ben Harber

Drawing By: Dan Sponholz

Version: 1.0

Date: 2019.06.30



er



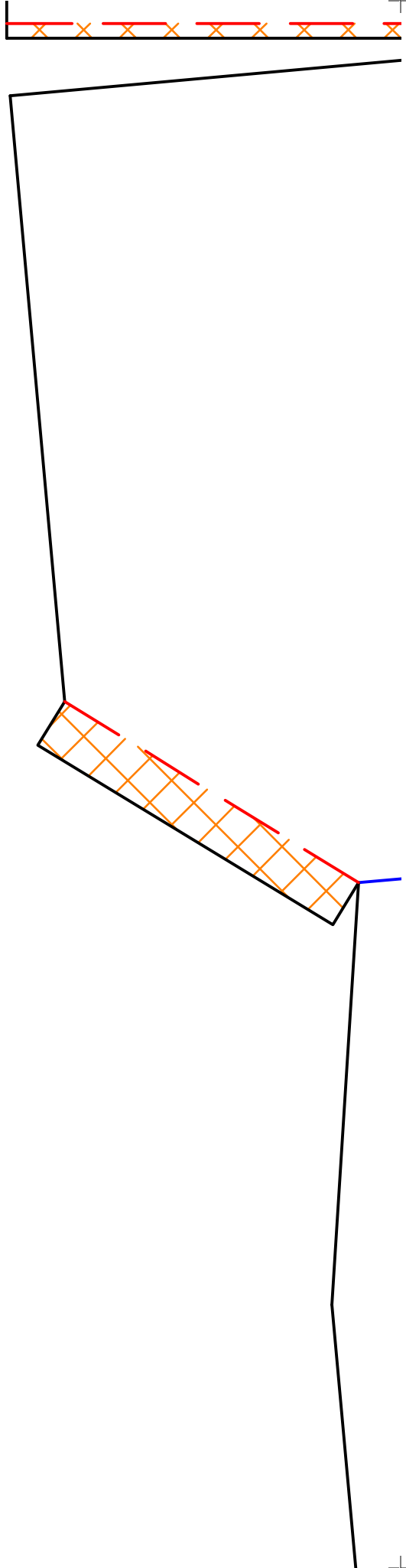

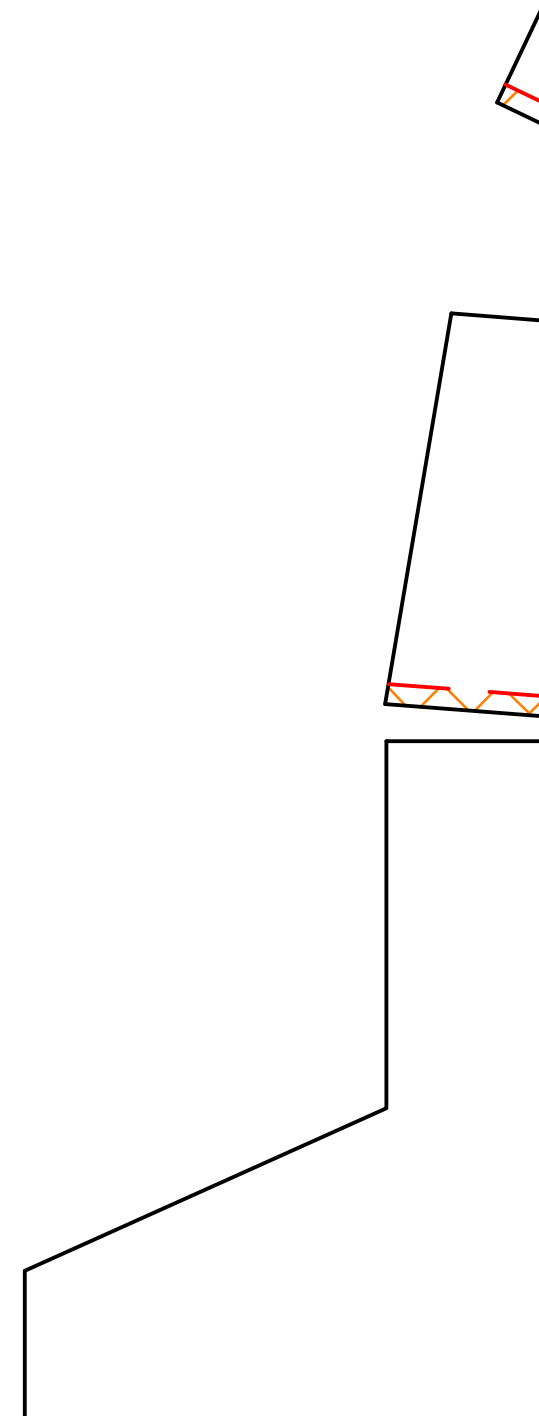



IN



CM

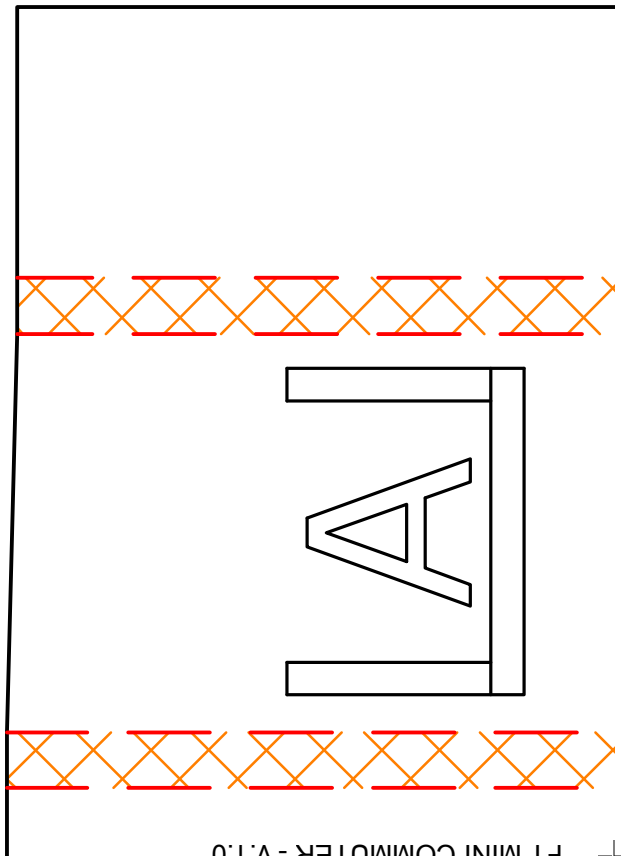

F1 MINI COMPUTER - V.1.0

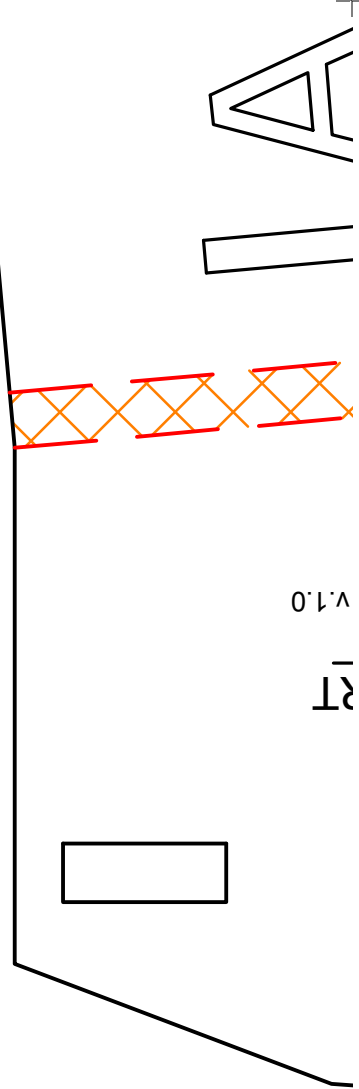

RT
V.1.0

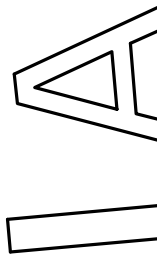

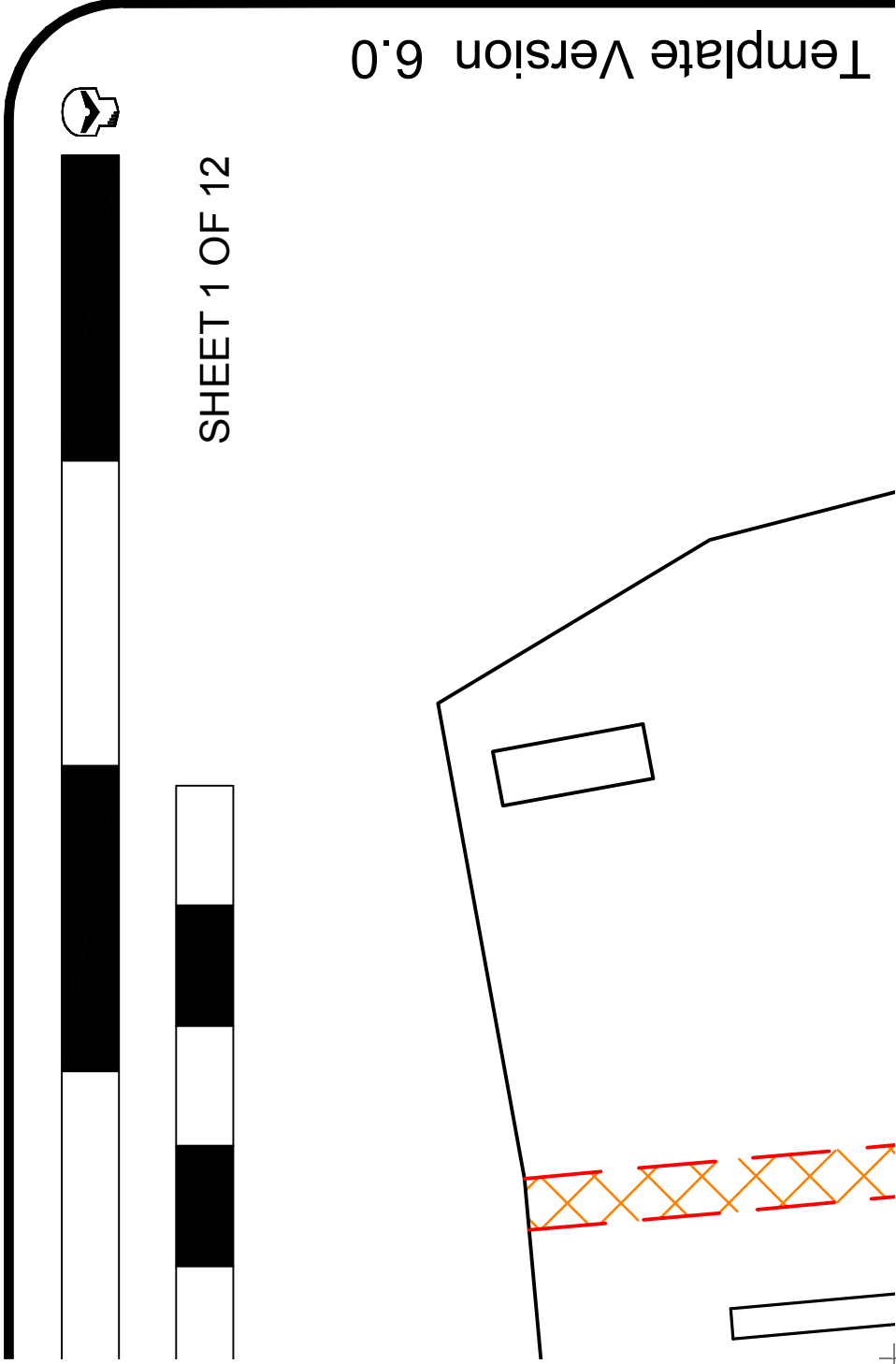

Template Version 6.0



SHEET 1 OF 12



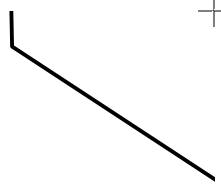
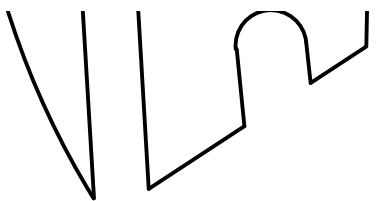
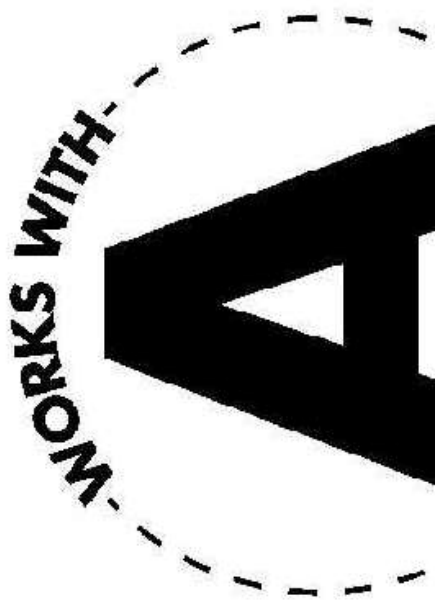

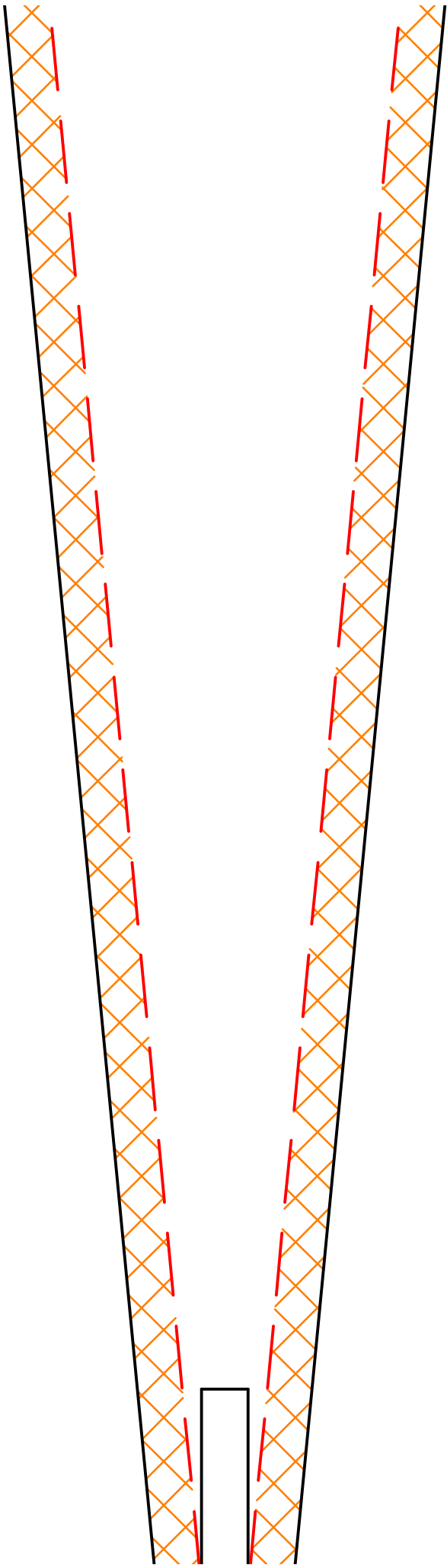
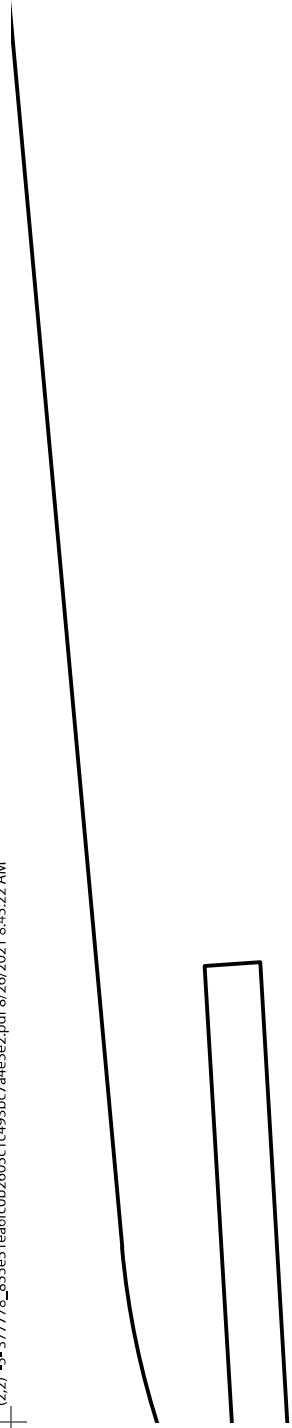

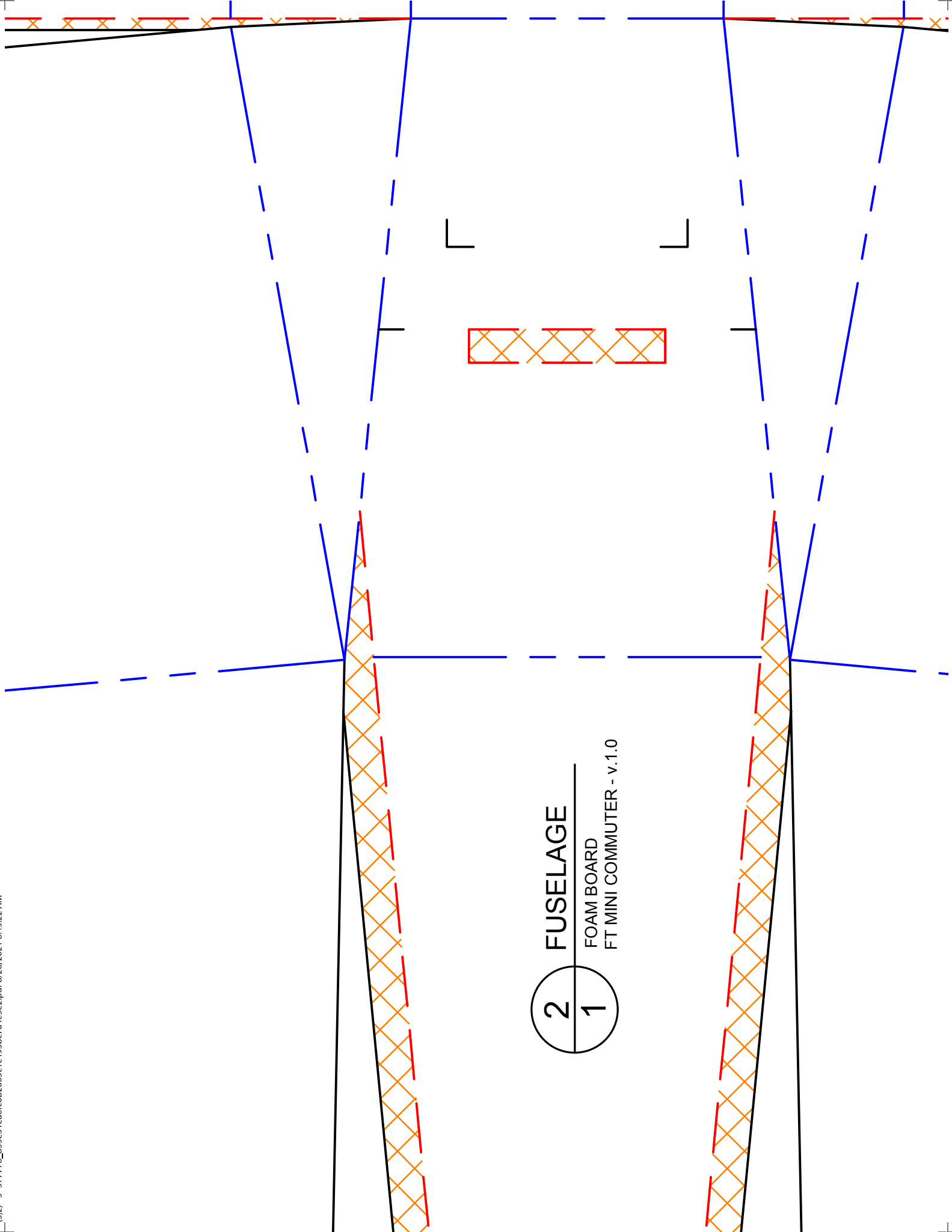

2
1

FUSELAGE

FOAM BOARD

FT MINI COMMUTER - v.1.0

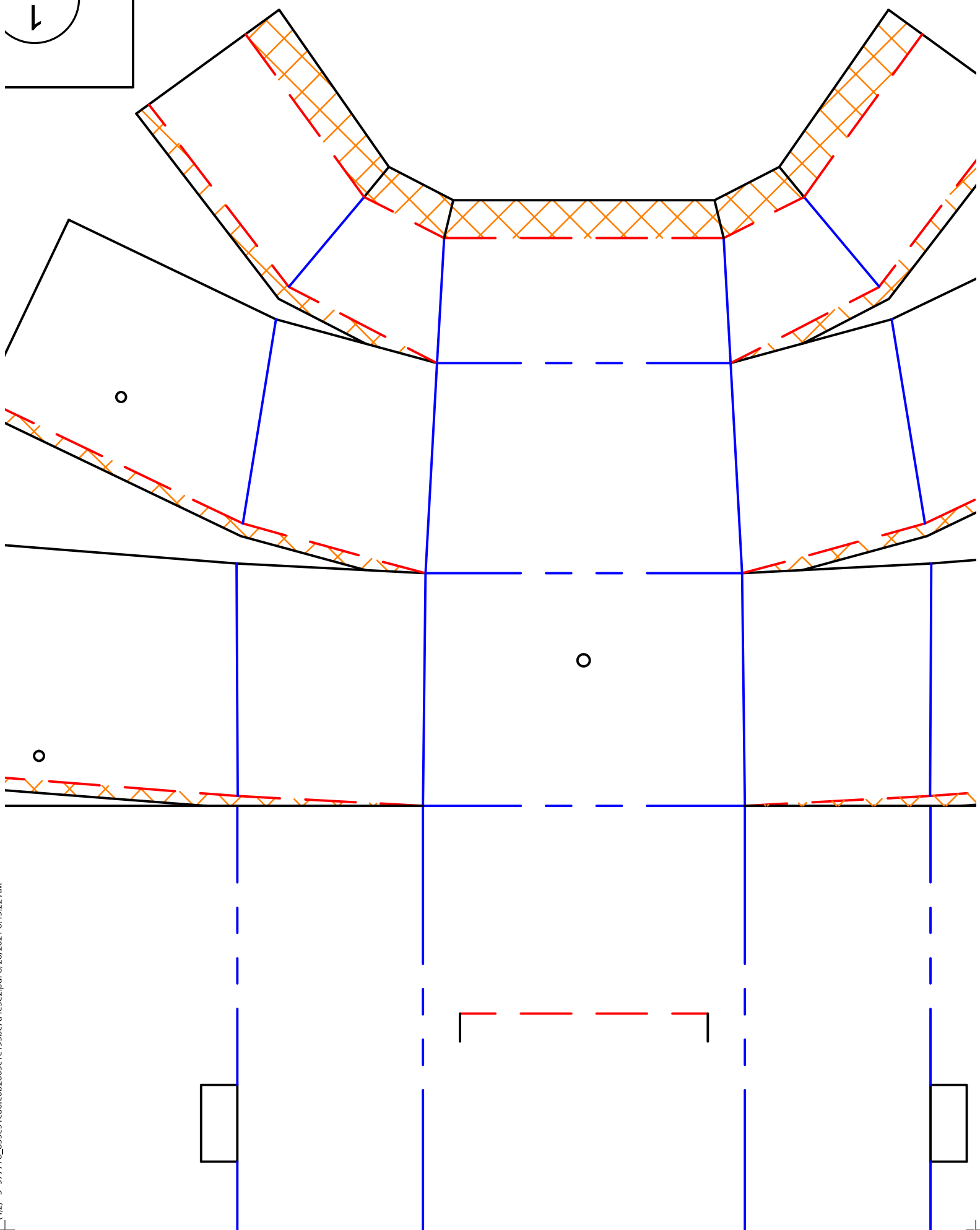
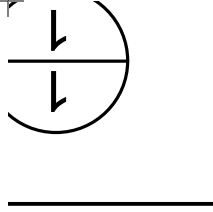

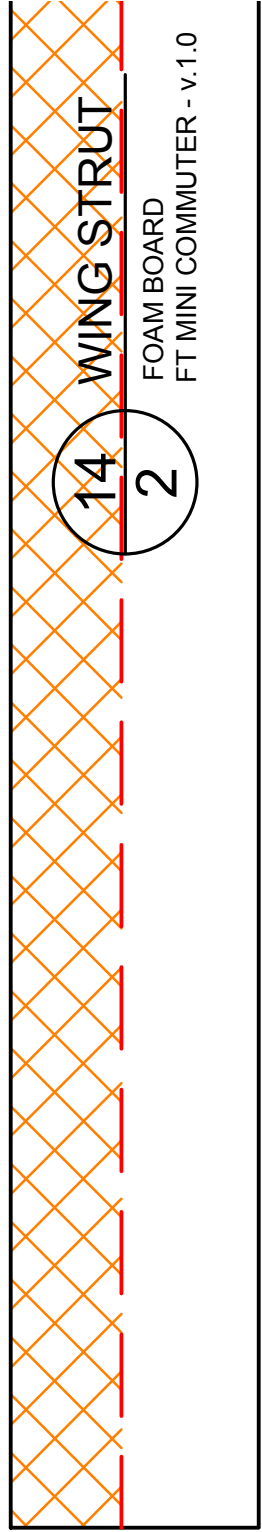
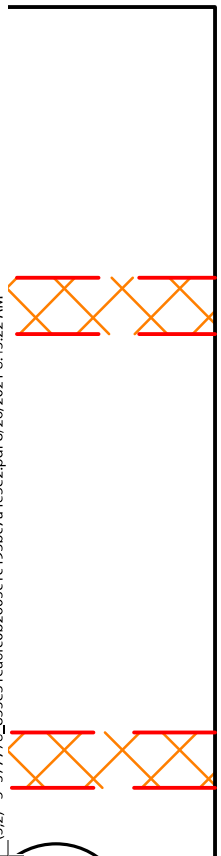
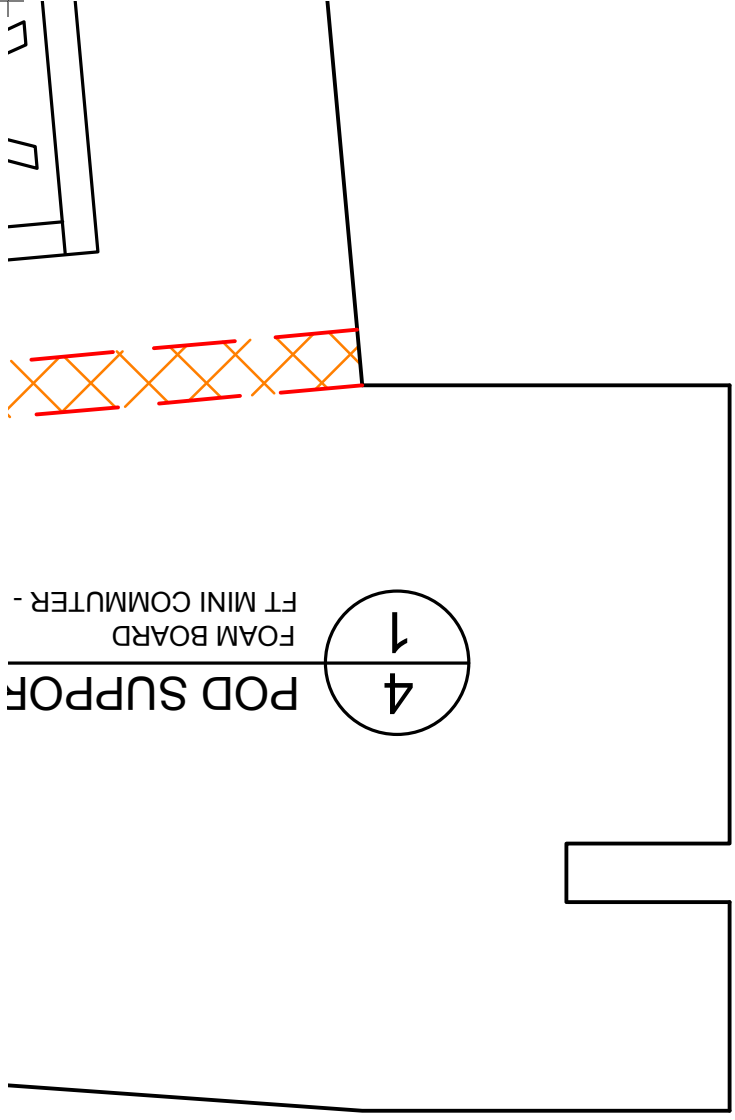

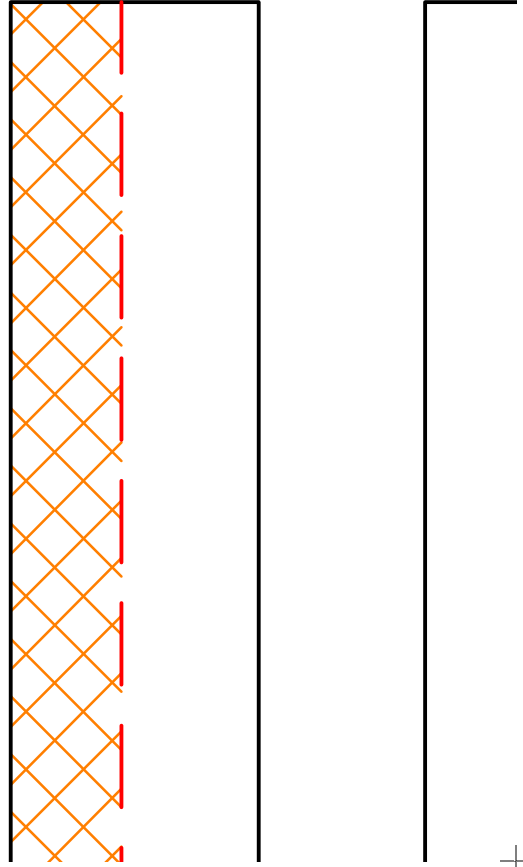
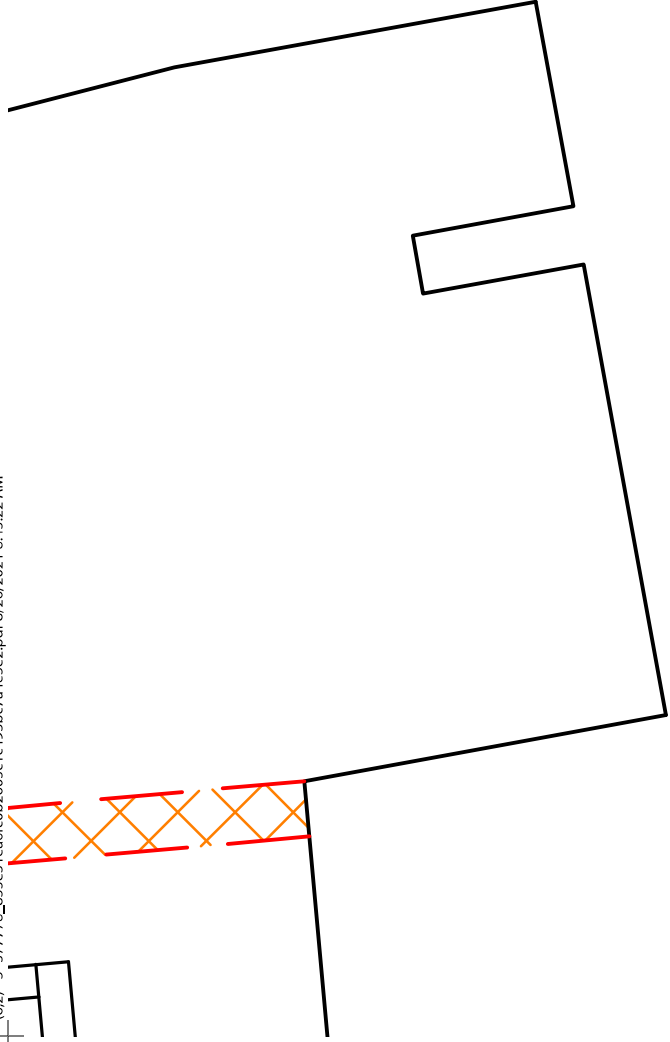

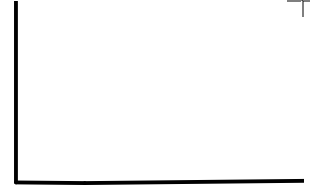
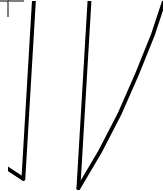

5
1

POD SUPPORT BOTTOM PLATE

FOAM BOARD
FT MINI COMMUTER - v.1.0

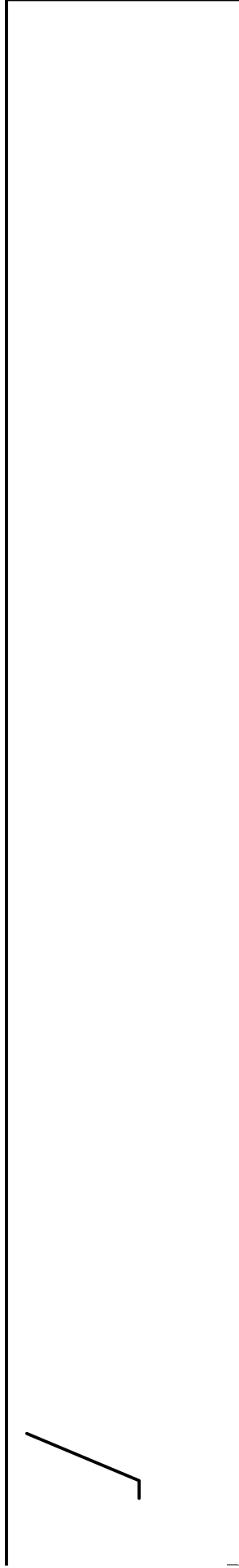
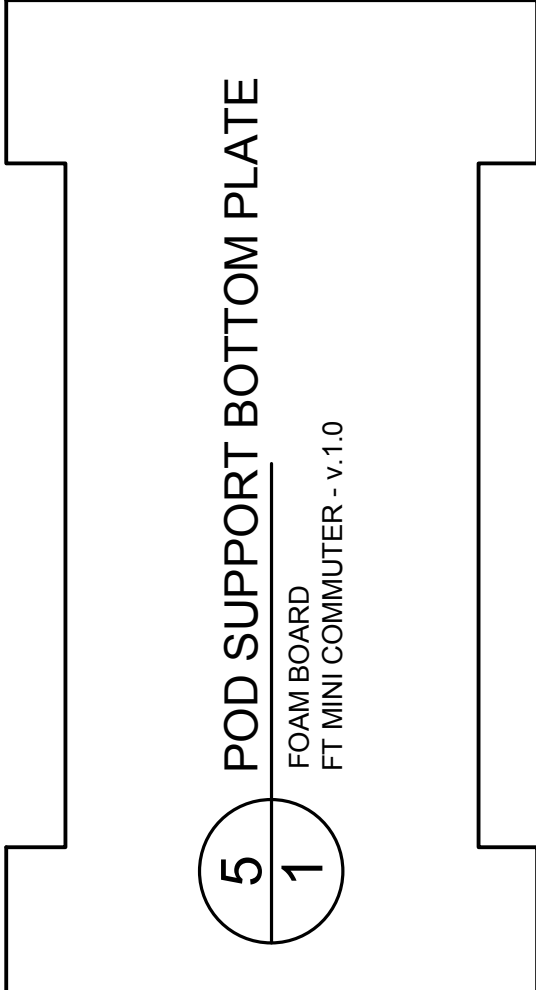

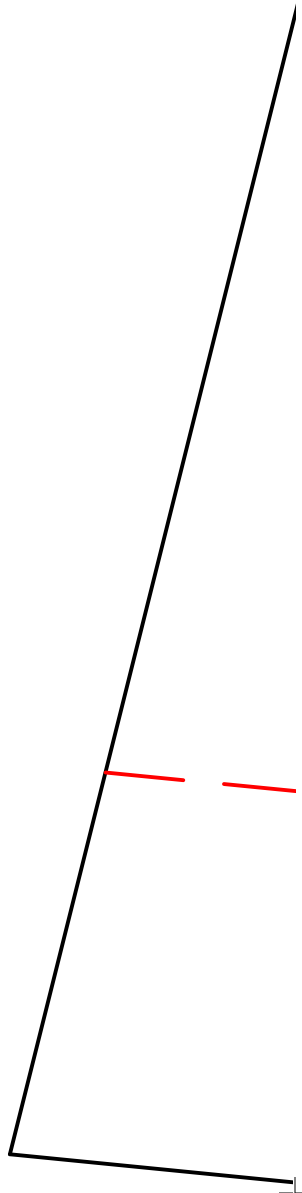
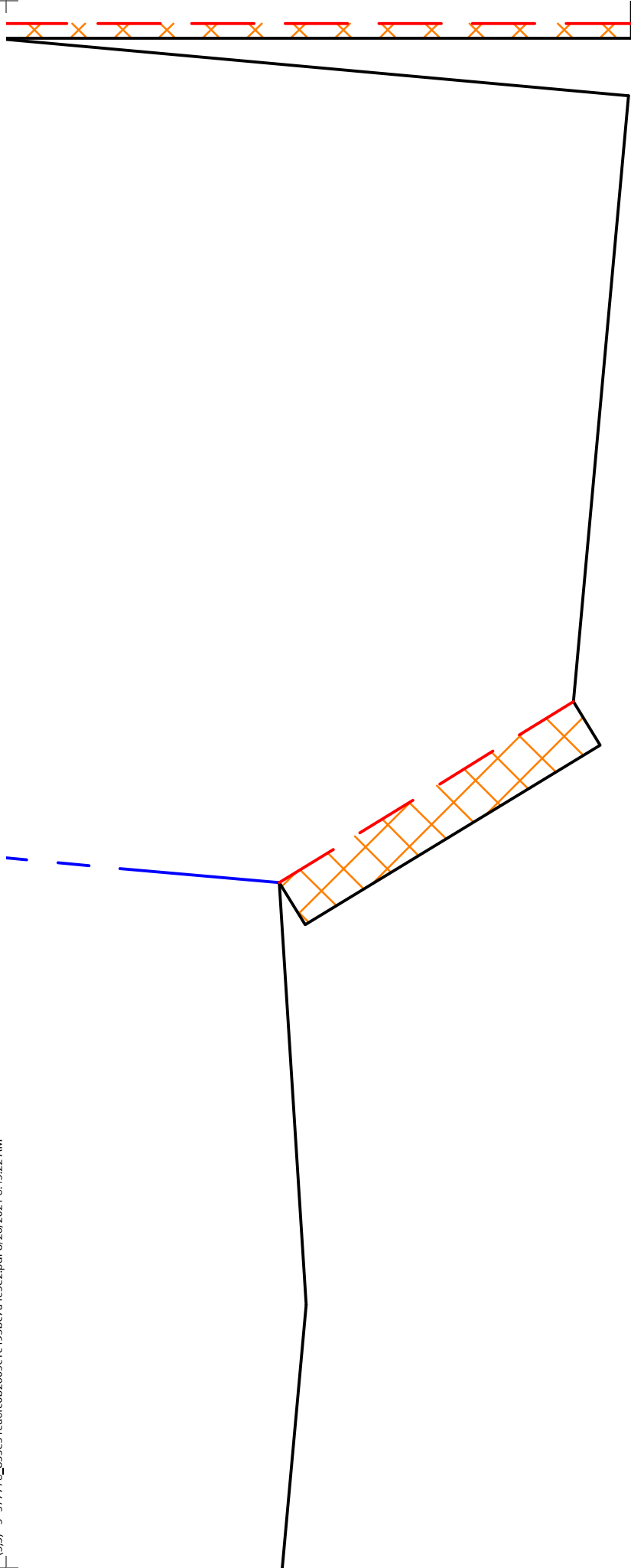

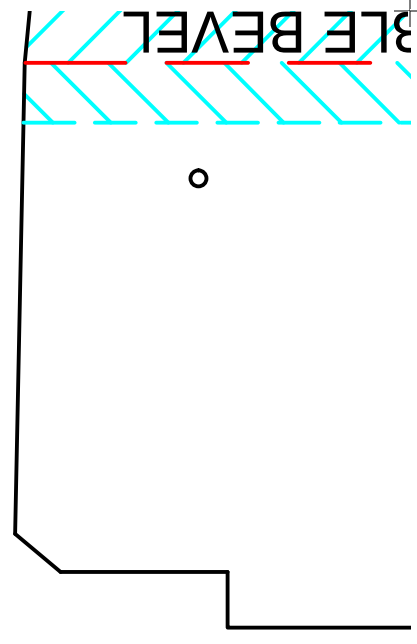
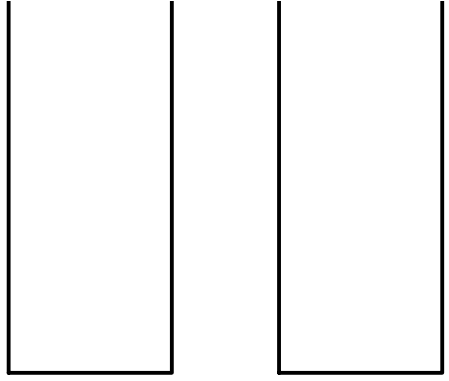
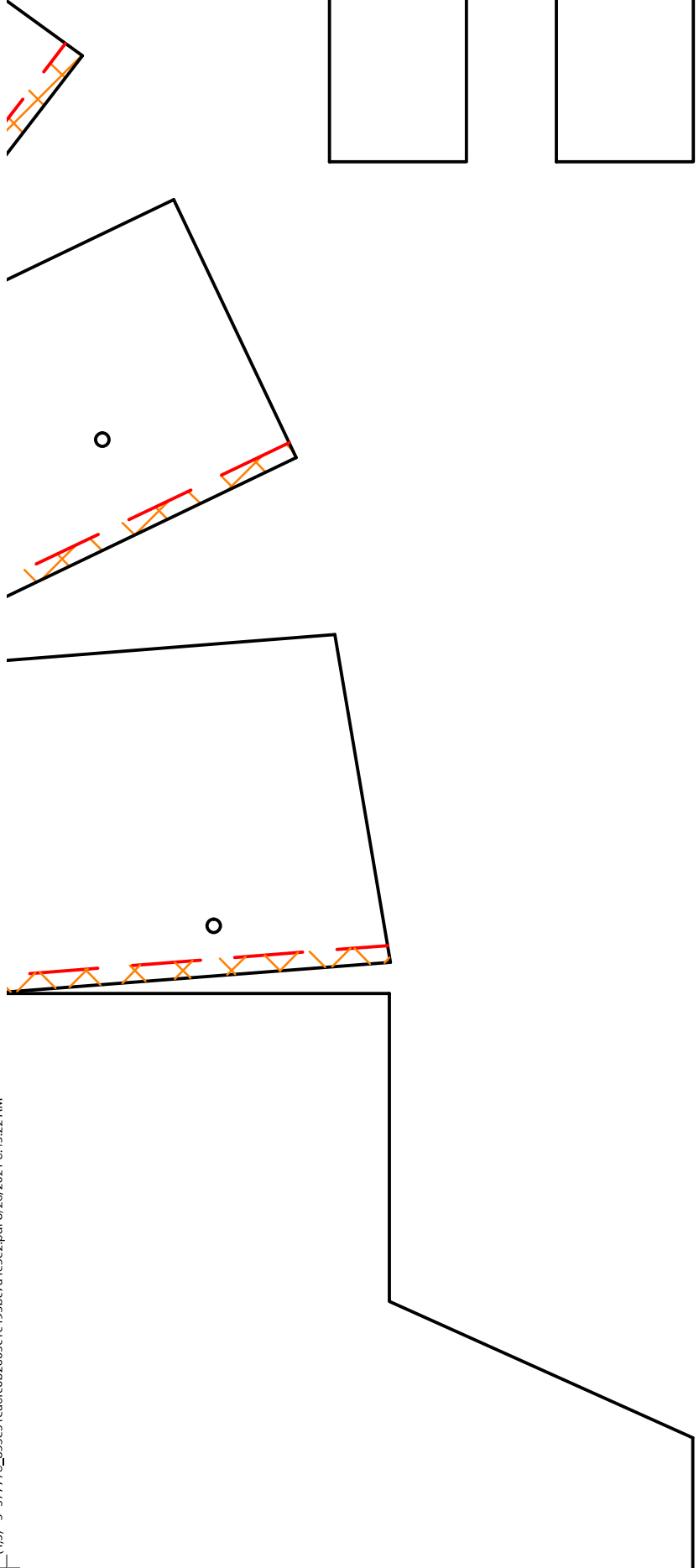

(14) WING SIRUI



2

FOAM BOARD
FT MINI COMMUTER - v.1.0

13

WING SPAR

2

FOAM BOARD
FT MINI COMMUTER - v.1.0

13

WING SPAR

2

FOAM BOARD
FT MINI COMMUTER - v.1.0

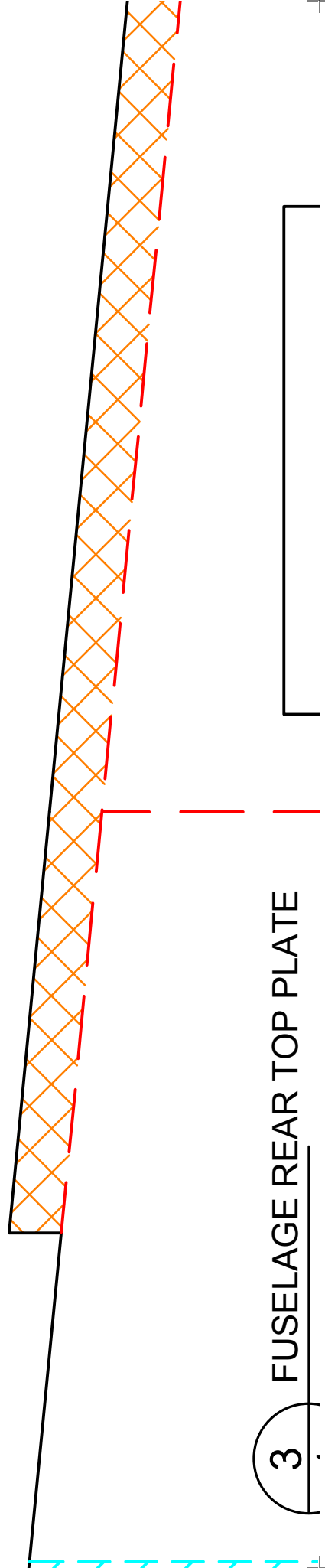

3

FUSELAGE REAR TOP PLATE

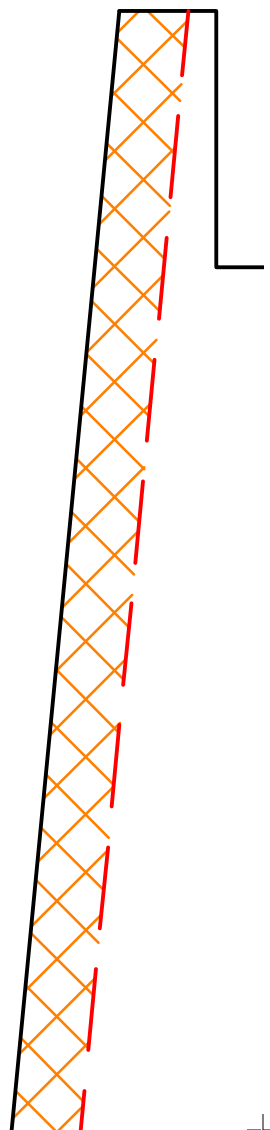
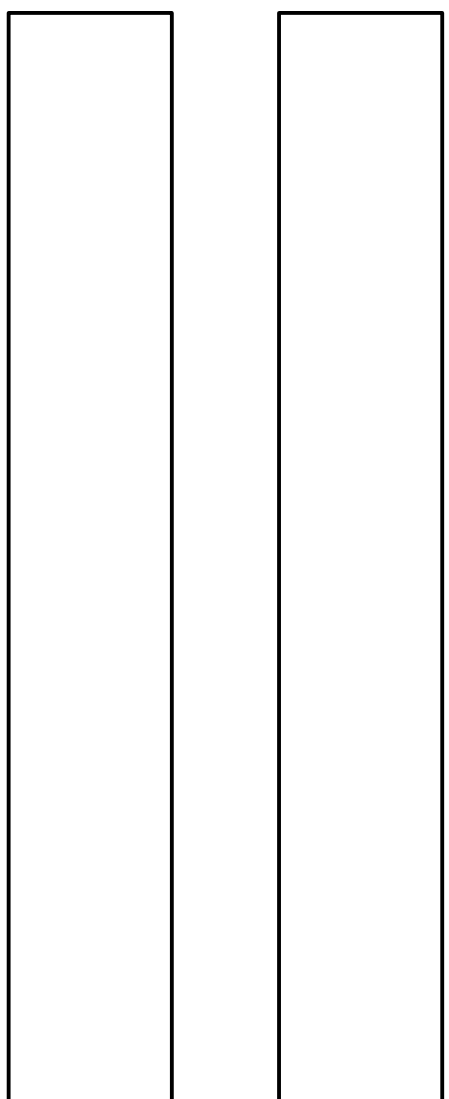
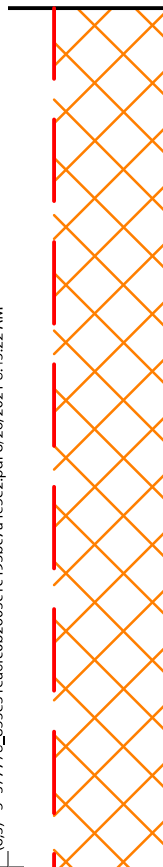

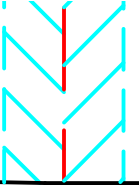

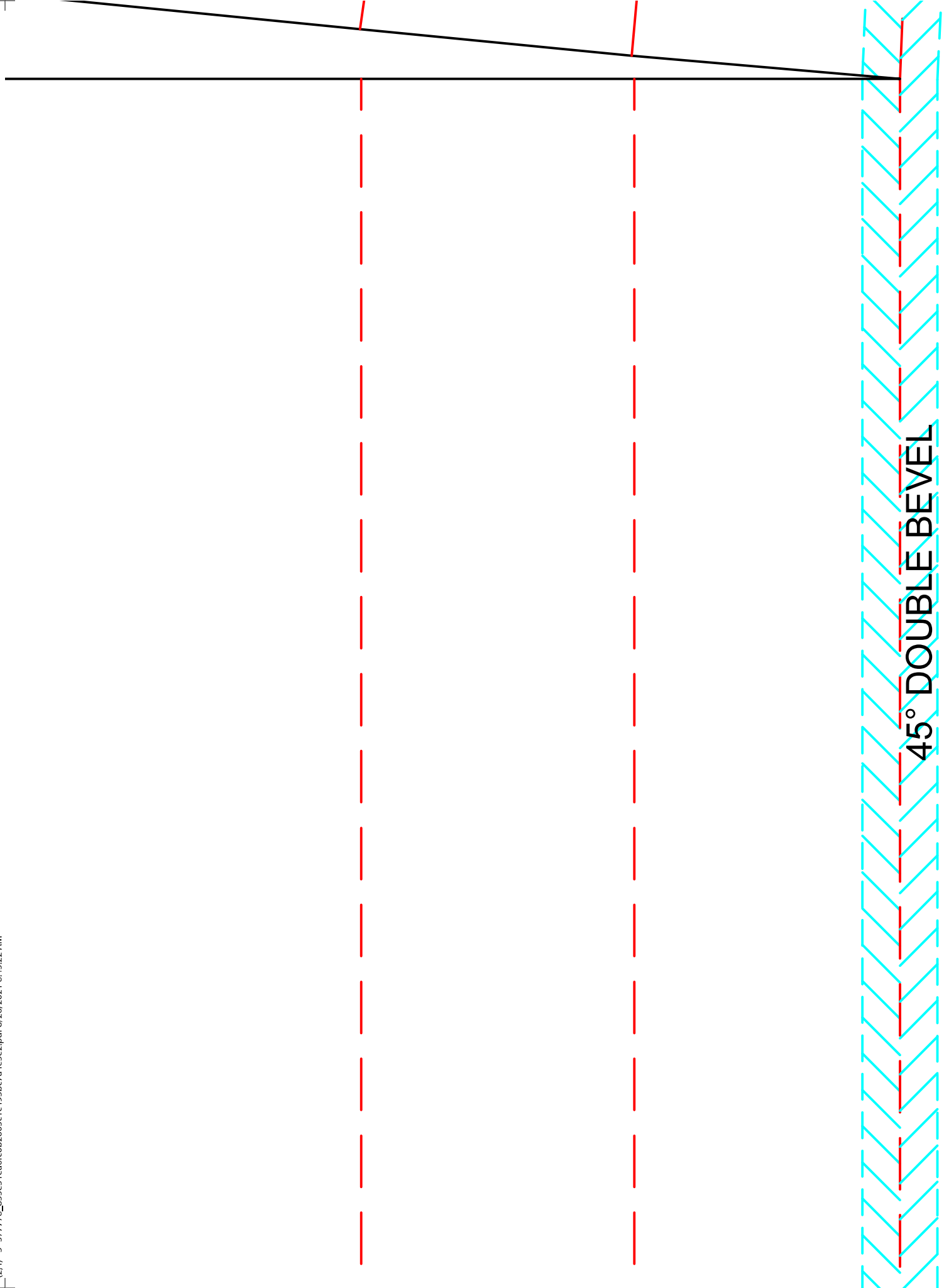

45° DOUBLE BEVEL

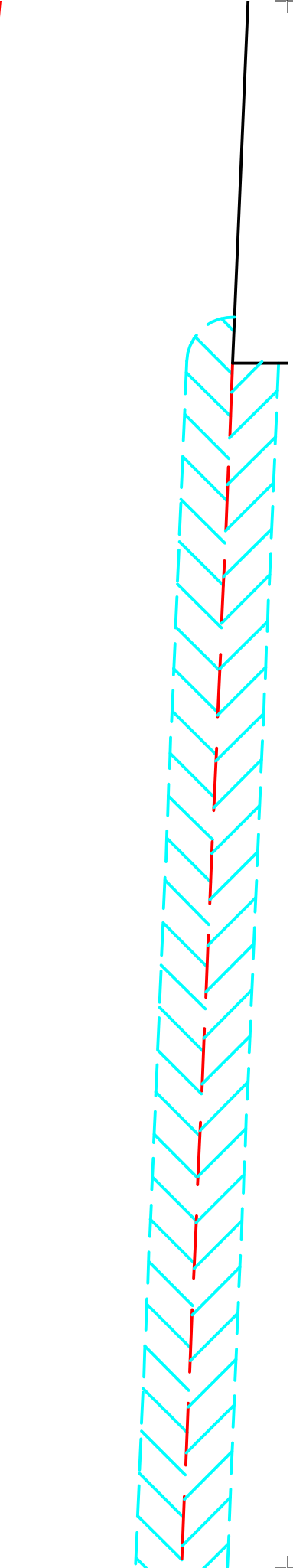
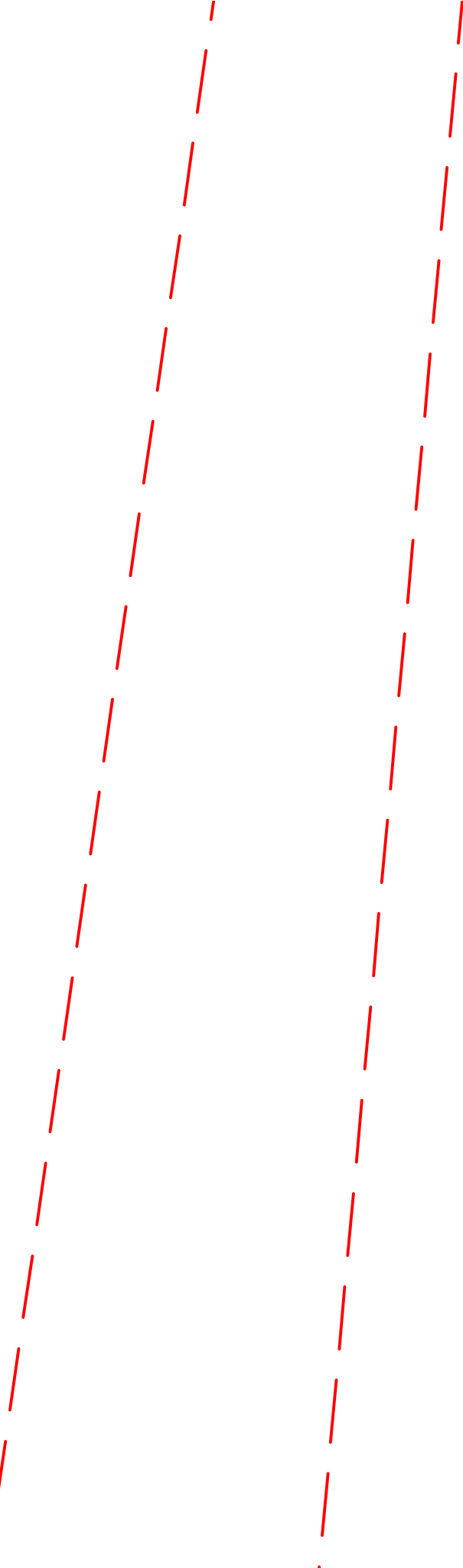
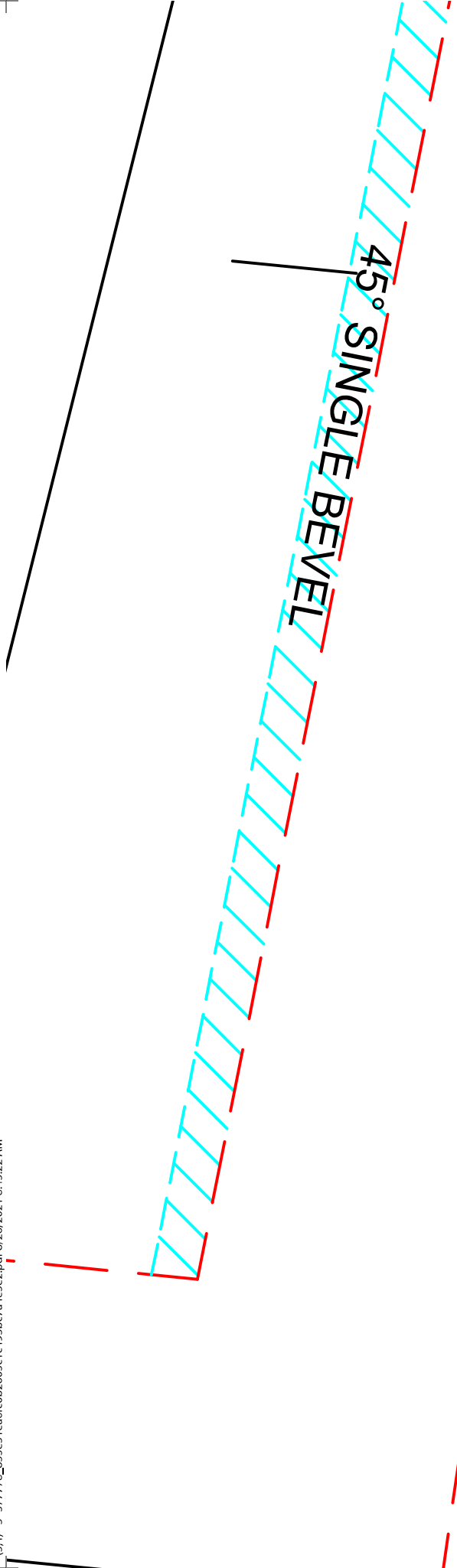

45° DUNE

10
1

VERTICAL STABIL
FOAM BOARD
FT MINI COMMUTER - v.1.0

45° SINGLE BEVEL

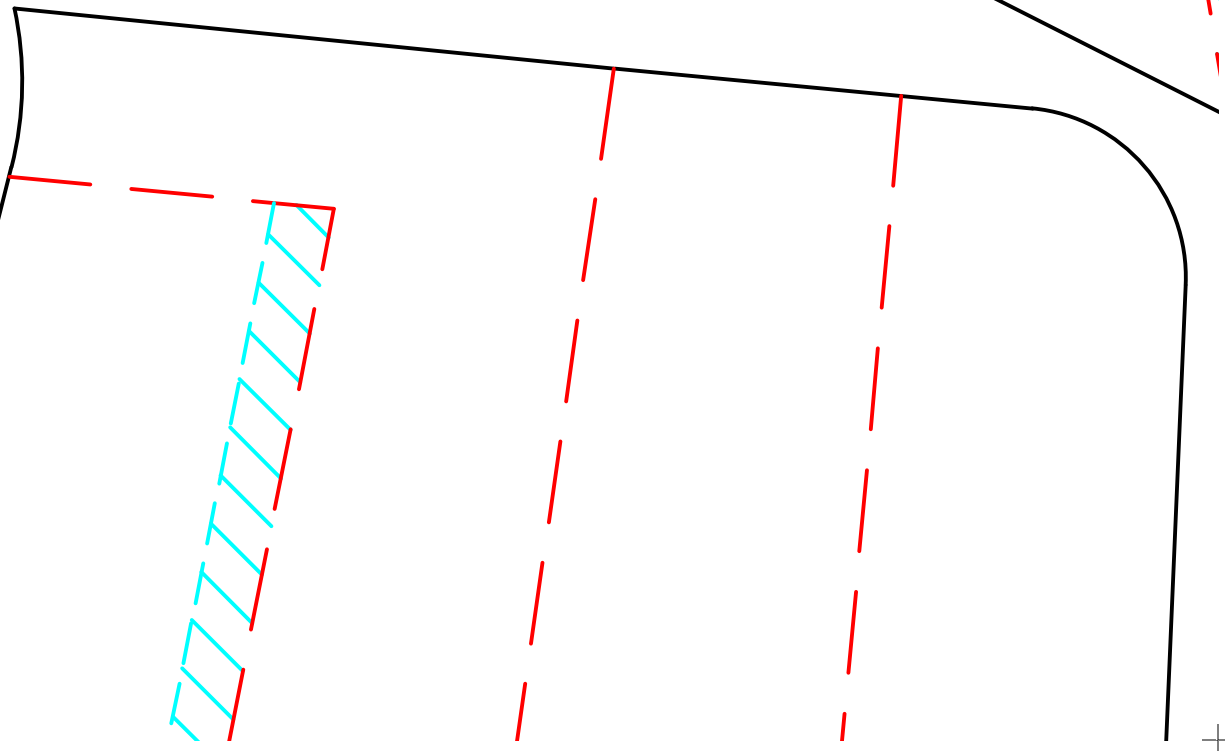
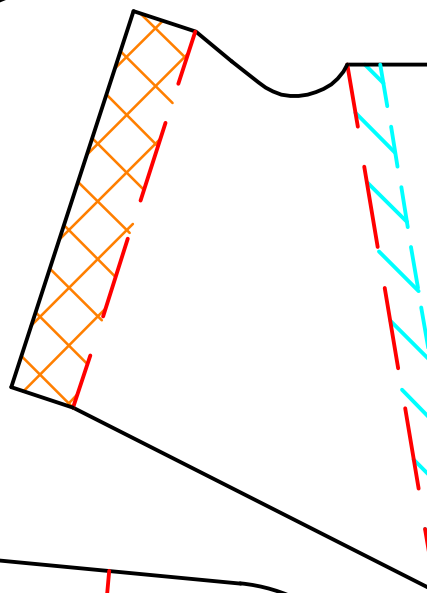

1
FOAM BOARD
FT MINI COMMUTER - v.1.0

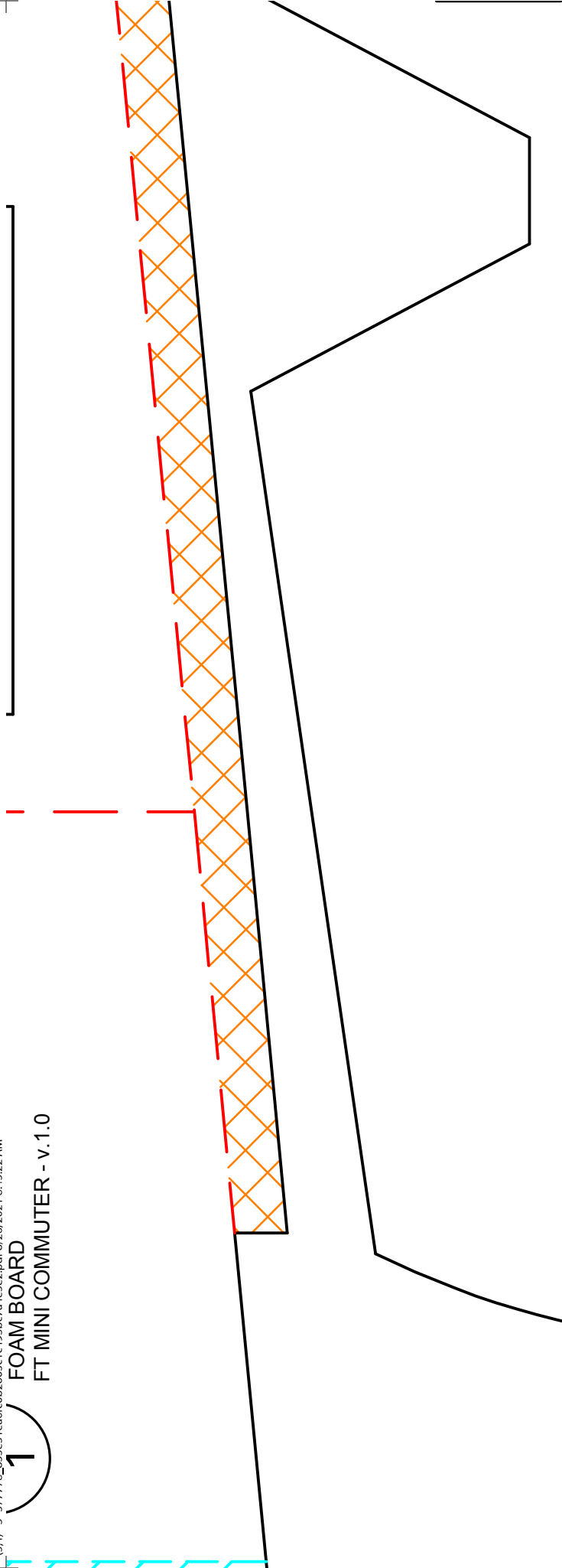

9
1

HORIZONATAL STABILIZER

FOAM BOARD
FT MINI COMMUTER - v.1.0



IZER

of charge. Copies allowed for personal use only. Not for com

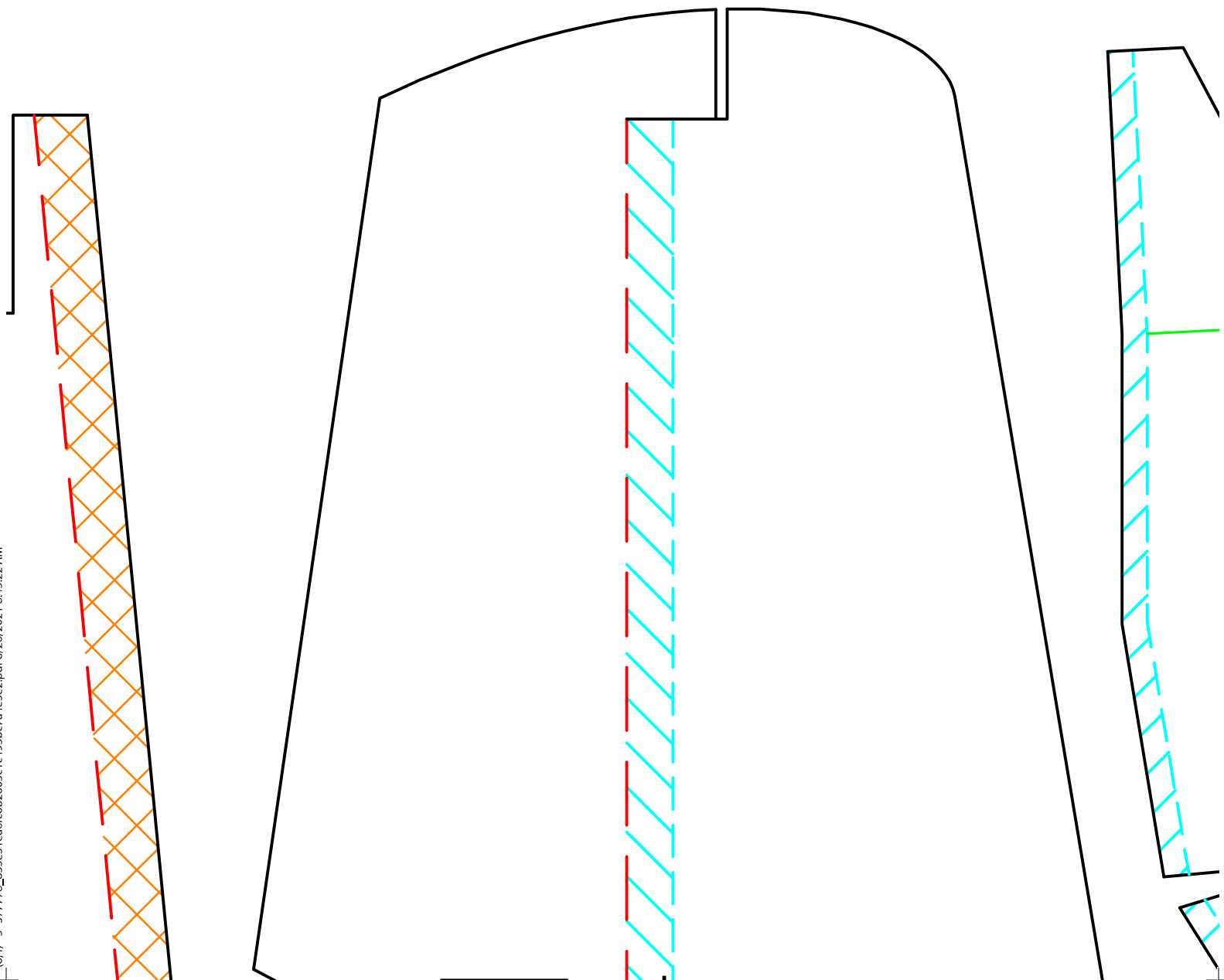



SPONZ



www.flitetest.com

12
1

RIGHT WING PANEL

FOAM BOARD

FT MINI COMMUTER - v.1.0

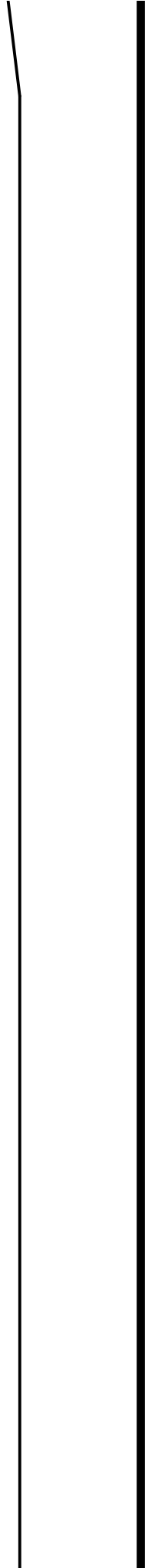
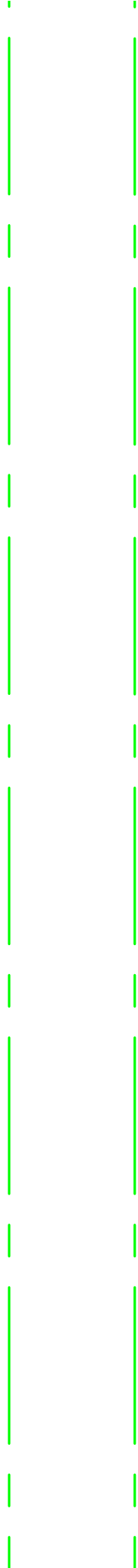

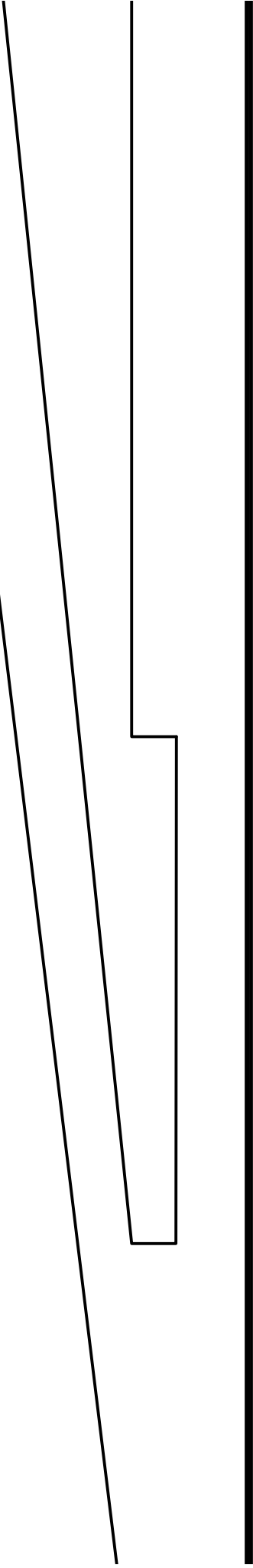
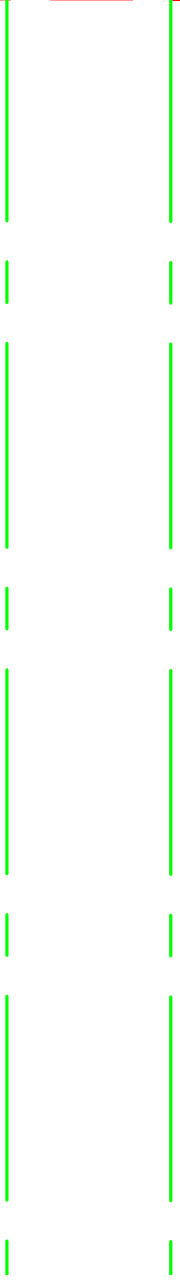
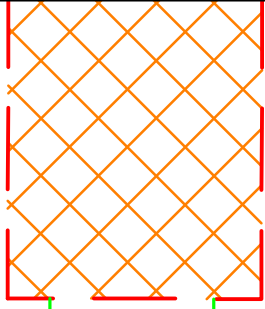

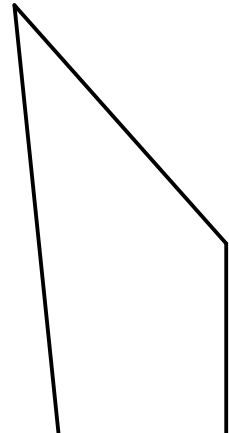
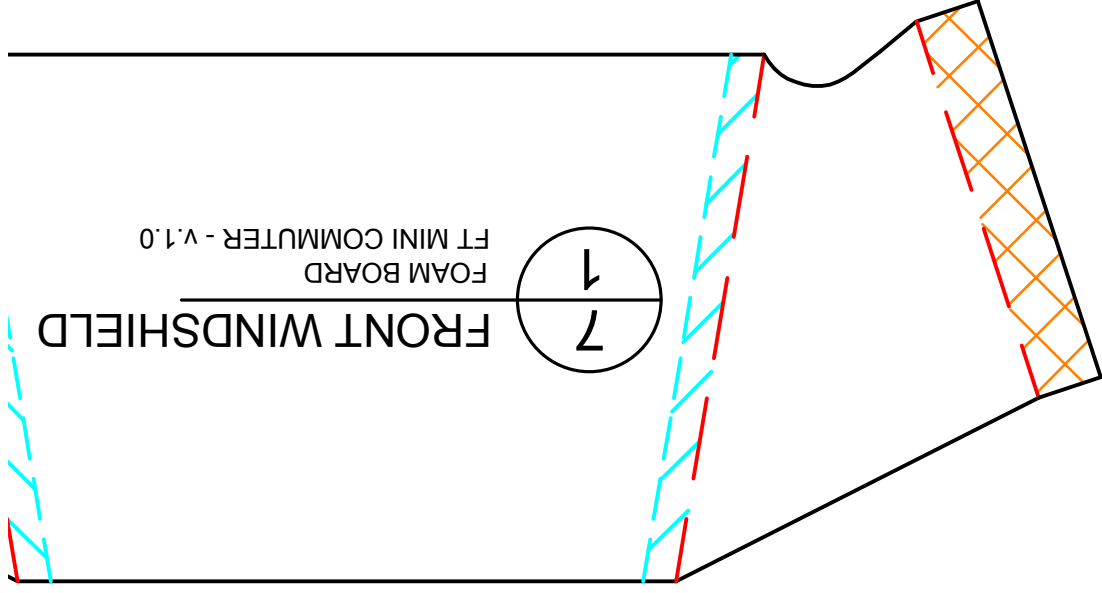
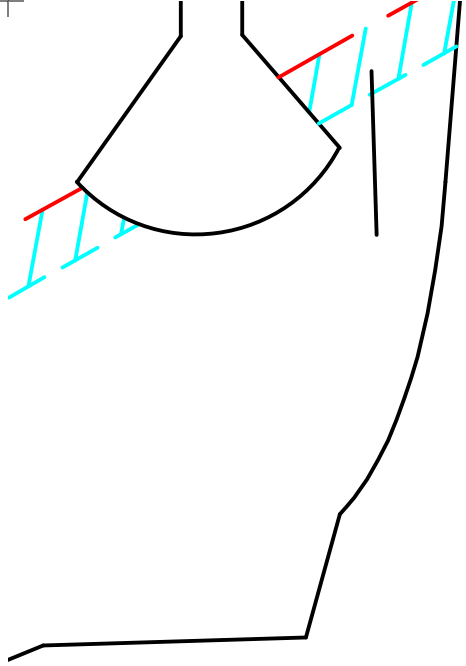

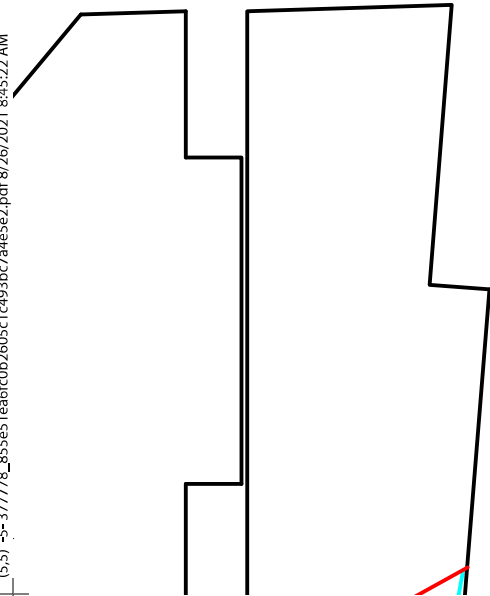
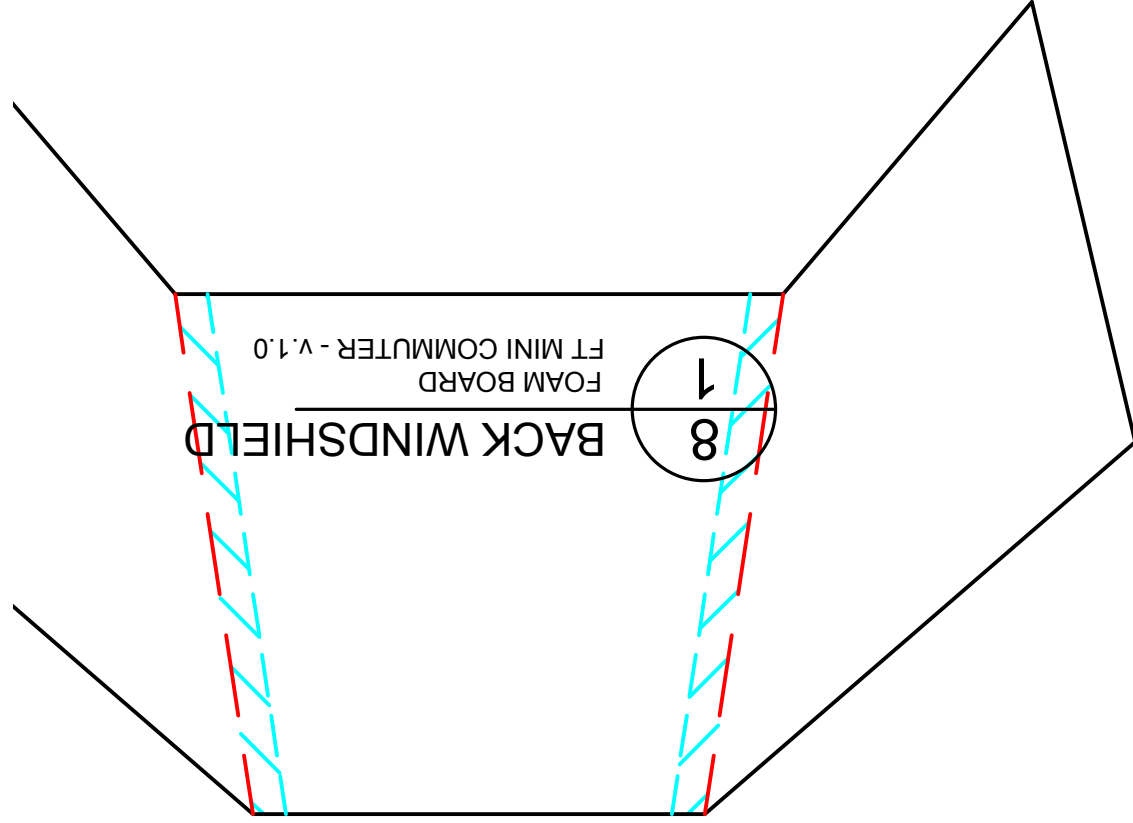
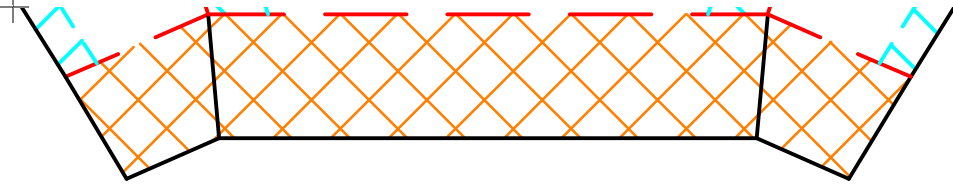

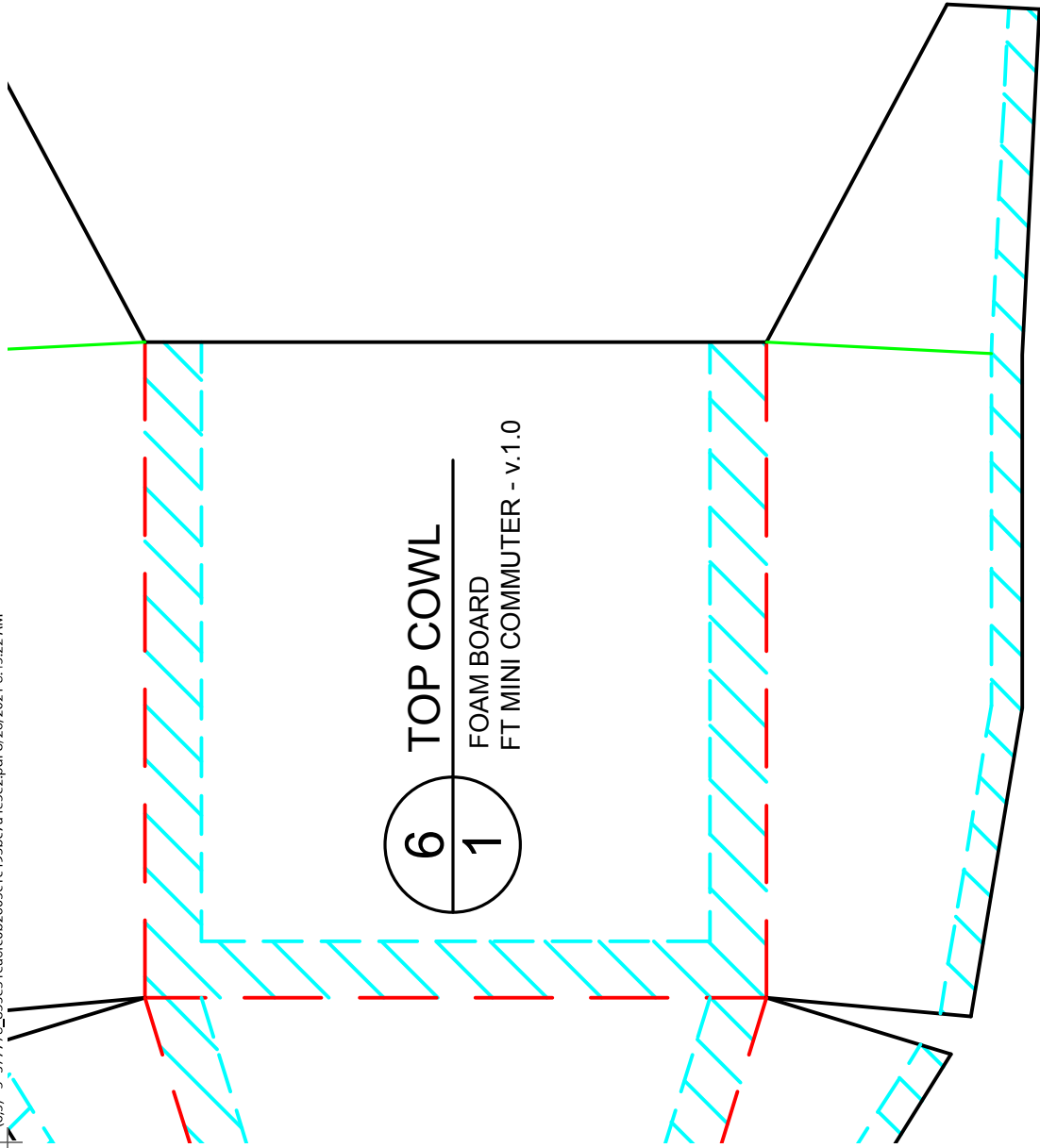

FT Mini Commutator

Designed By: Ben Harber

Drawing By: Dan Sponholz

Version: 1.0

Date: 2019.06.30

er

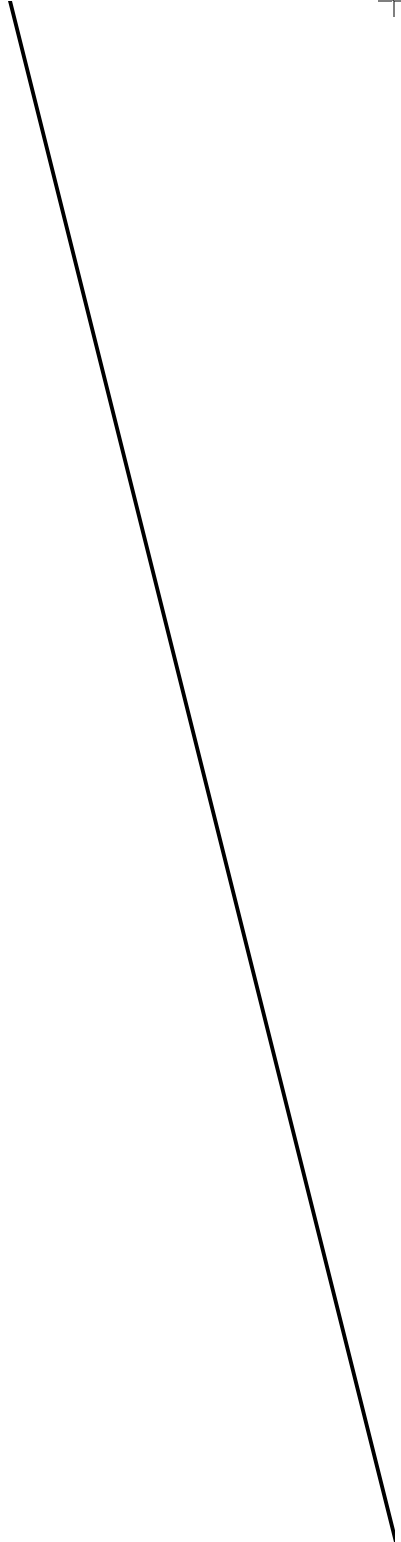

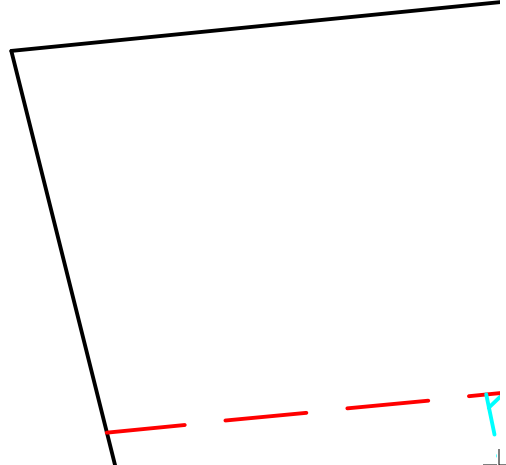
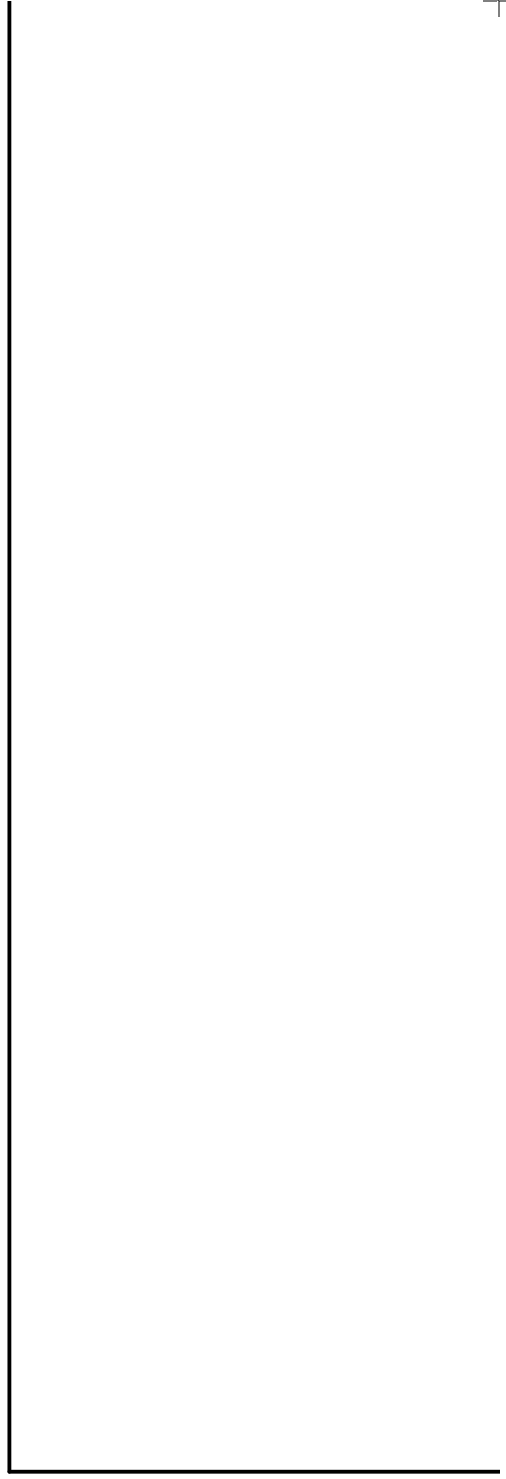

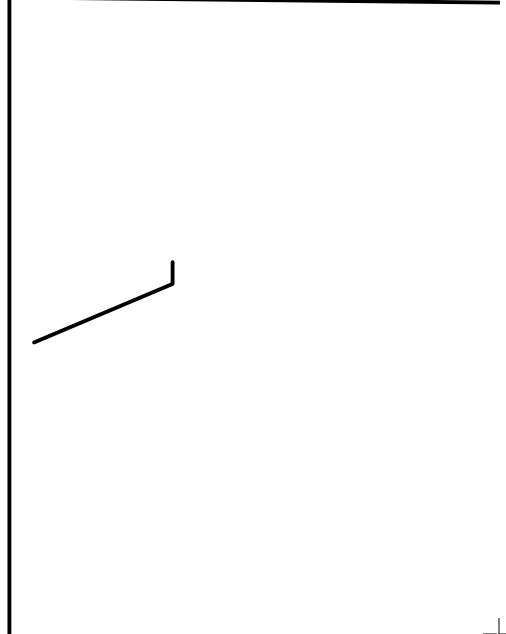







IN



CM





SHEET 2 OF 12

Template Version 6.0

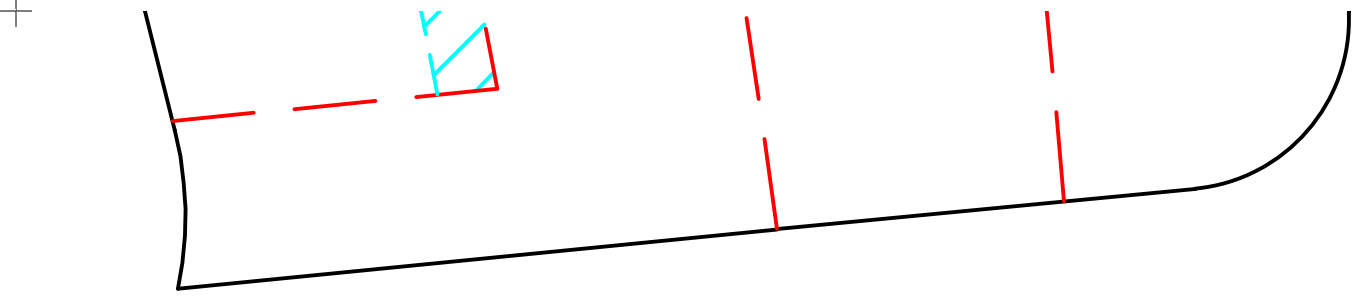
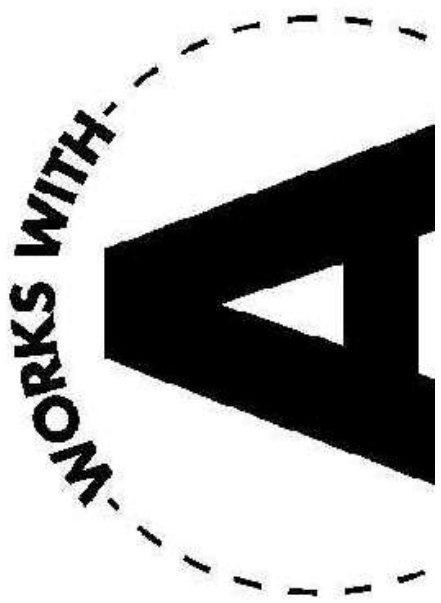

45° SINGLE BEVEL

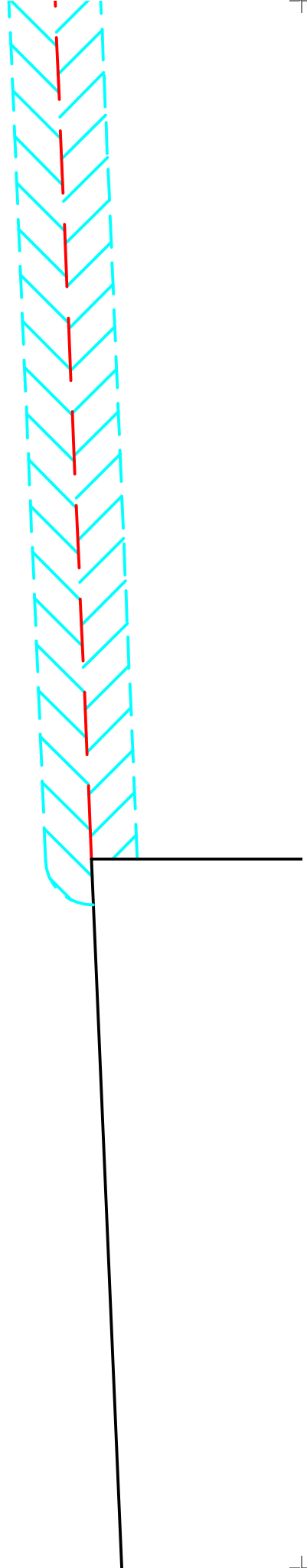
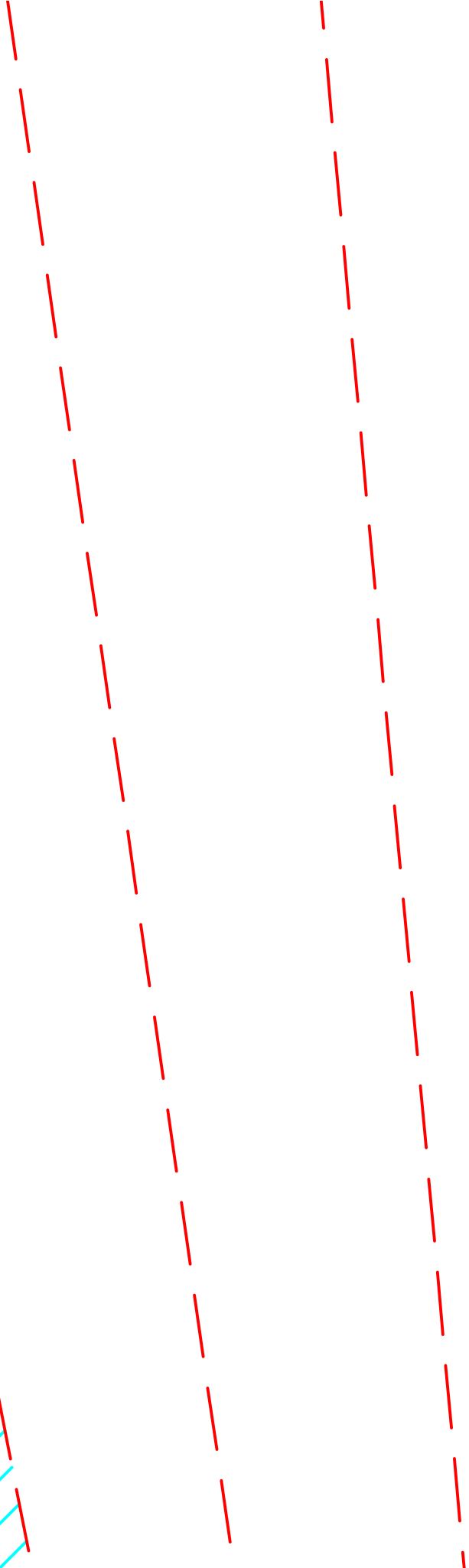
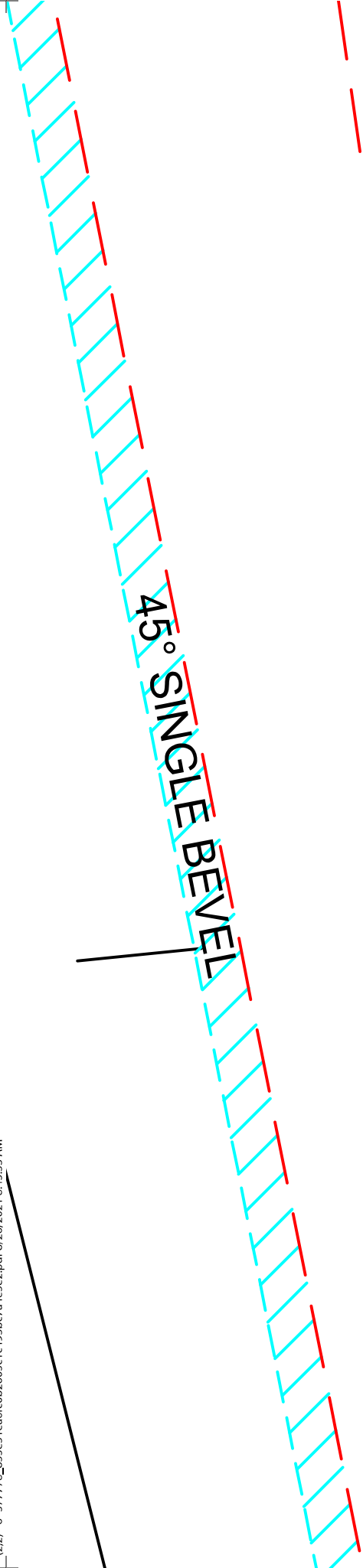

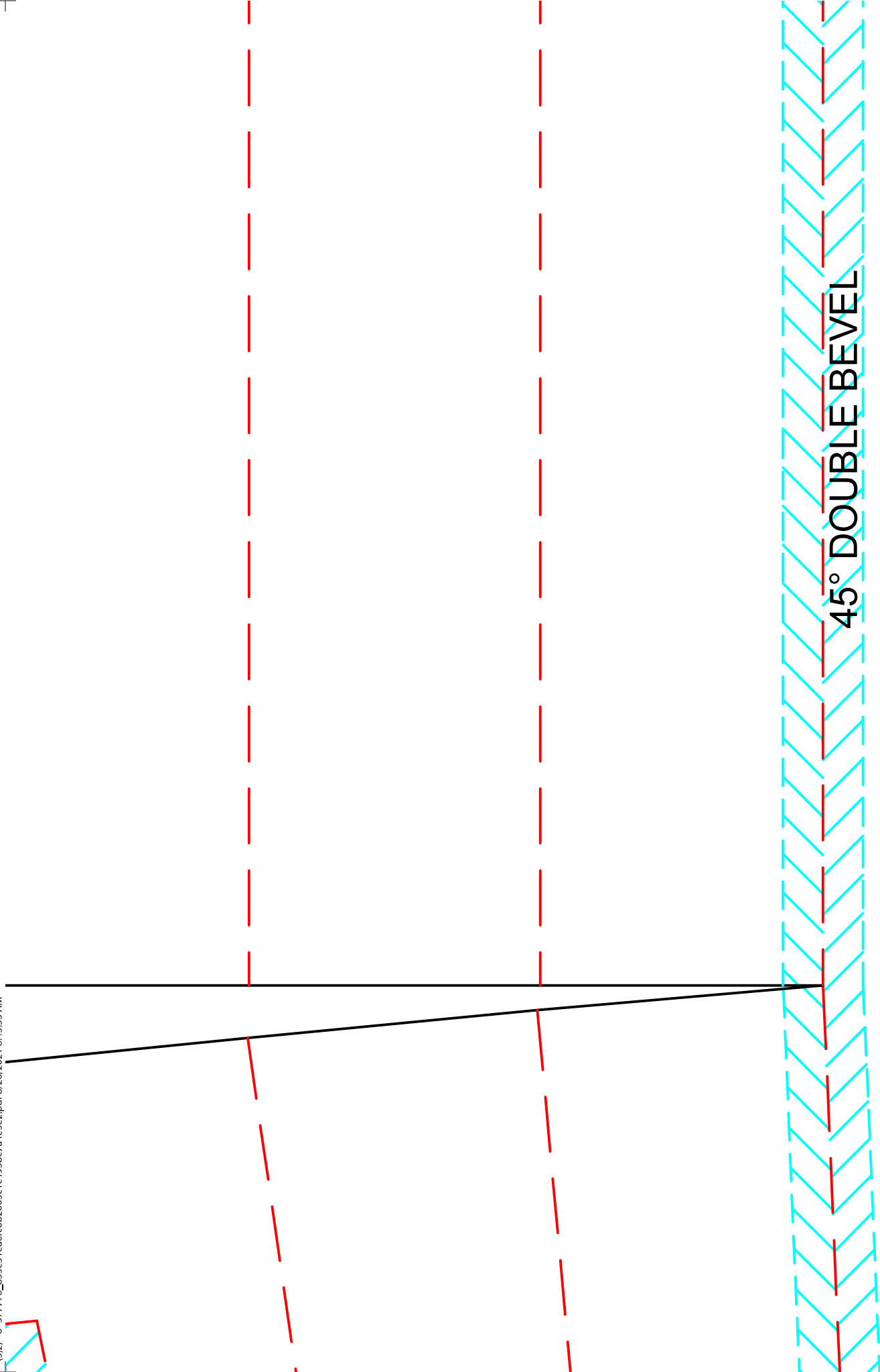

11 LEFT WING PANEL
FOAM BOARD
FT-AM11-COM-UNITED-148

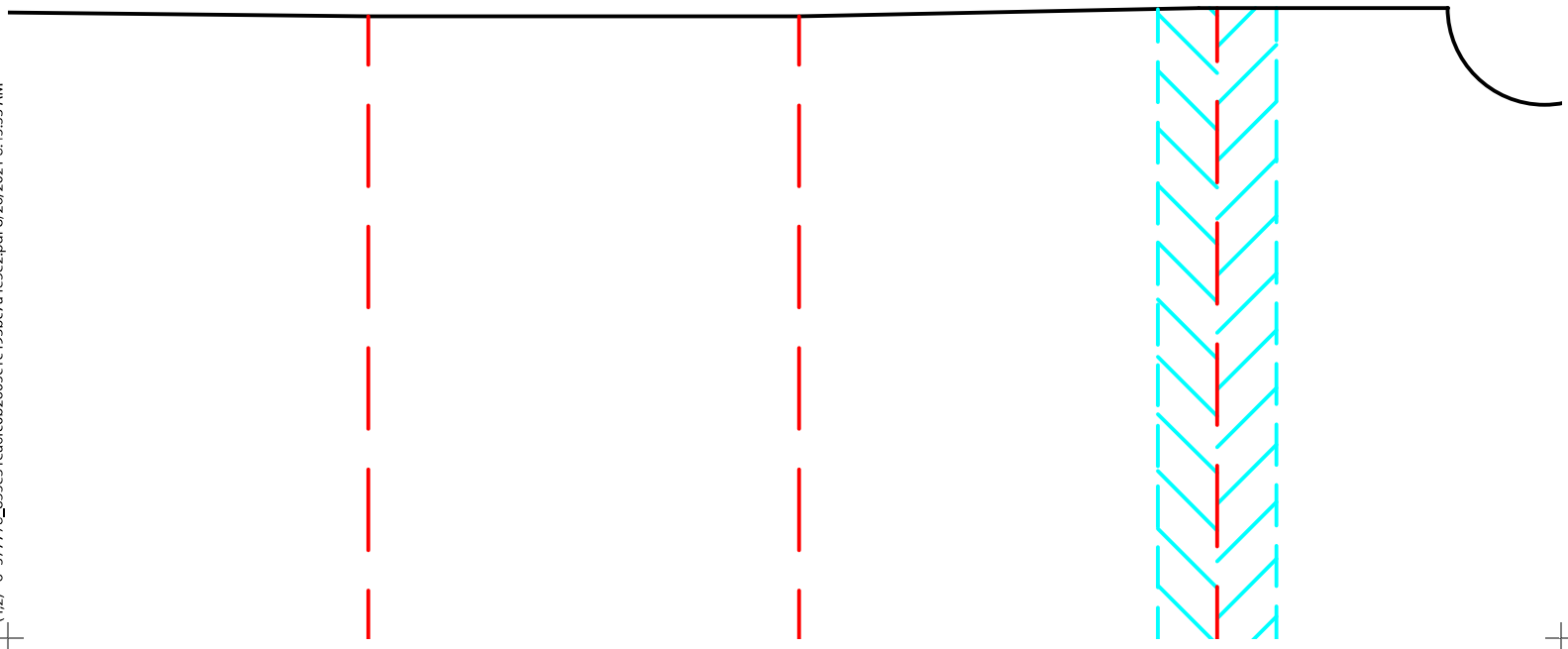



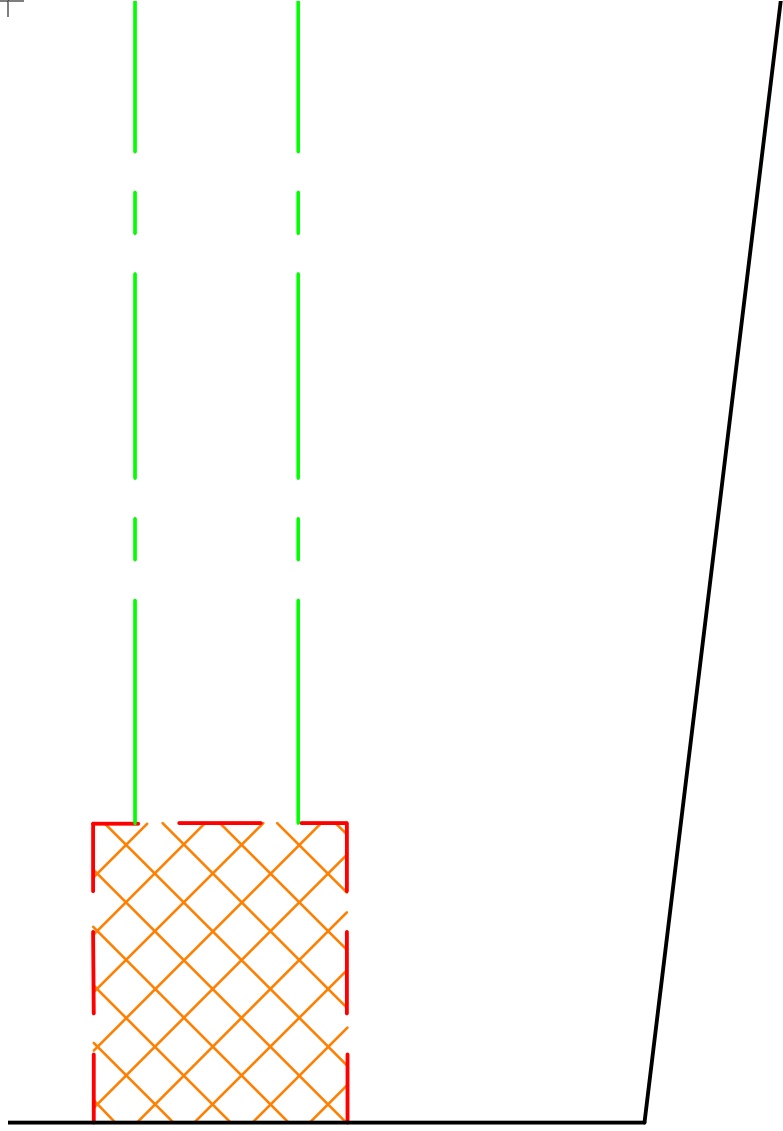

F I M I N I C O M M U N I E R - V. T. U



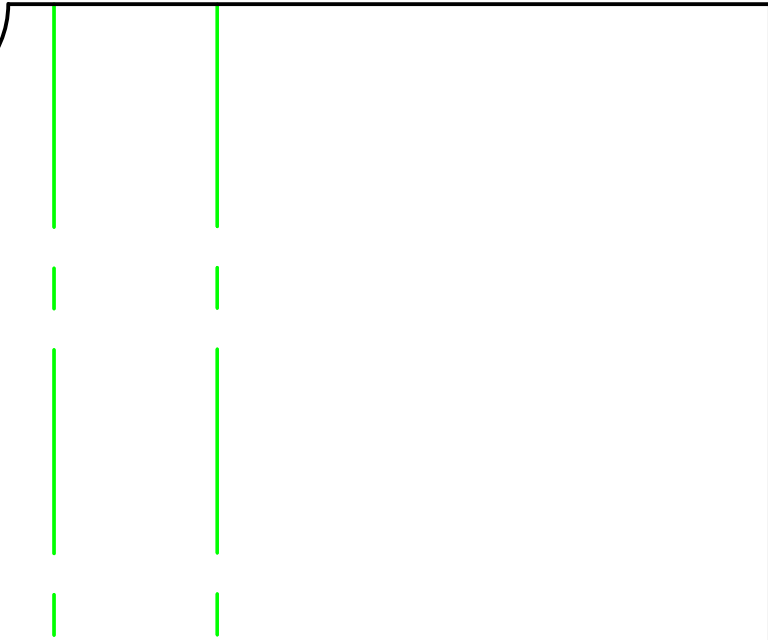

mercial use.



of charge. Copies allowed for personal use only. Not for com



SPONZ



www.flitetest.com

© 2019 FliteTest, LLC. Plans provided free