



www.flitetest.com

FT Mini Commuter

Designed By: Ben Harber
Drawing By: Dan Sponholz
Version: 1.0
Date: 2019.06.30



GENERAL SPECIFICATIONS:

LENGTH:	23.00 in		584 mm
CG:	1.00 in		25.4 mm
WINGSPAN:	30.00 in		762 mm
WING AREA:	142.0 in ²		9.2 dm ²
DRY WEIGHT:	8.3 oz.		234 g
ALL UP WEIGHT:	10.0 oz.		284 g
WING LOADING:	10.1 oz/ft ²		31 g/dm ²
WCL:	10.2		
THROWS:	12°		
EXPO:	30%		
CHANNELS:	3-4 [THR AIL ELE RUD]		

RECOMMENDED ELECTRONICS:

MOTOR:	1806 2280 kv
PROPELLER:	6x3
ESC:	20a min.
SERVOS:	3-4X 5 g
BATTERY:	650-950 mAh 2S

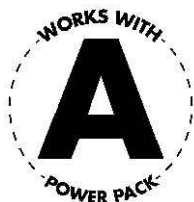

BUILD SKILL LEVEL:



PILOT SKILL LEVEL:





FT Mini Commuter: Full-Size Key

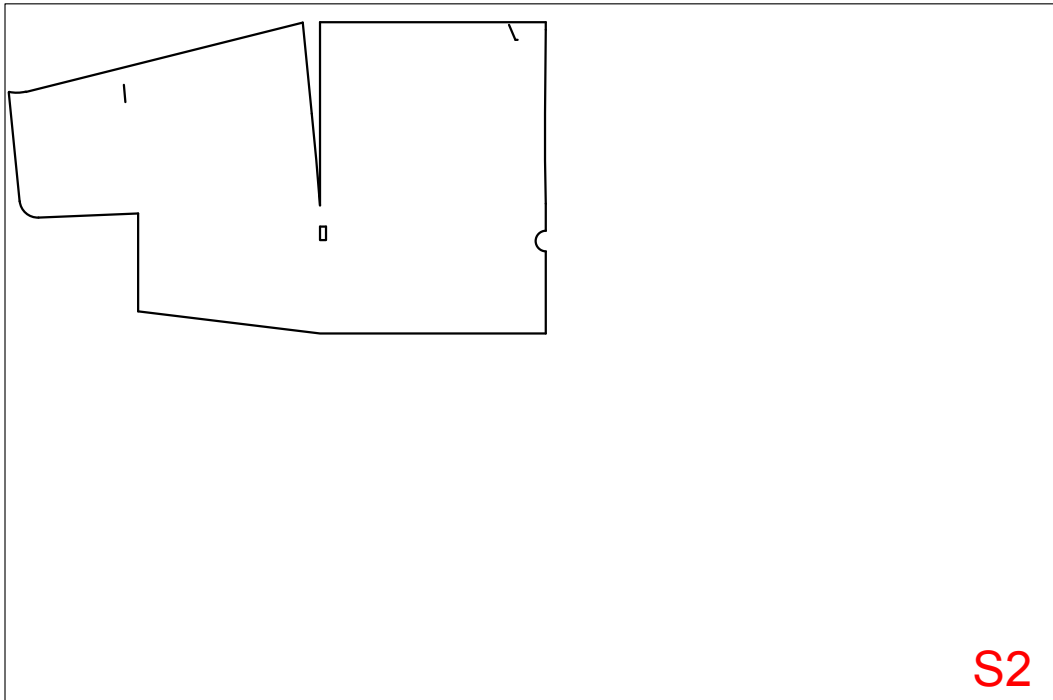
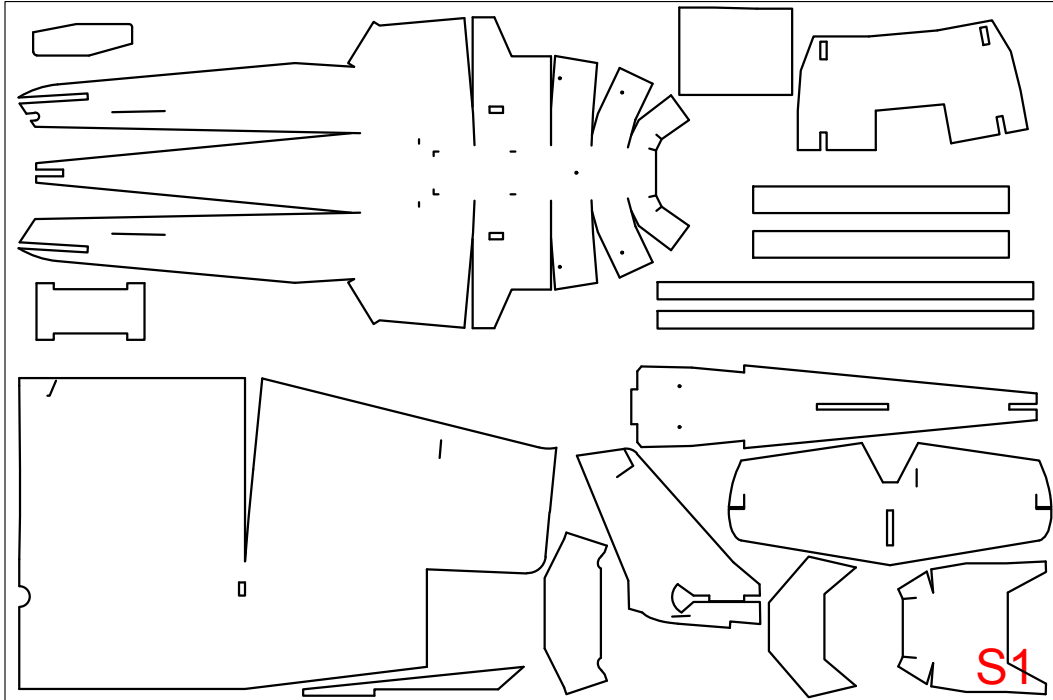



Drawing Key



FOLD TYPES

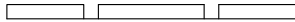
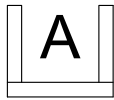

A - FOLD (ABOVE)

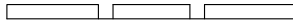
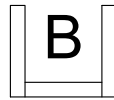
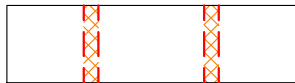

B - FOLD (BESIDE)

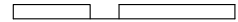
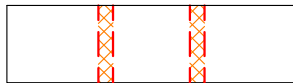

C - FOLD (COVER)

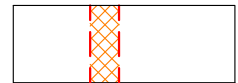

LINE TYPE/COLOR

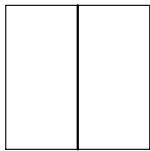

CUT

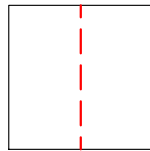
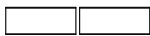

50% SCORE

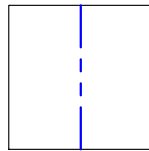
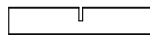

CREASE

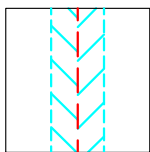
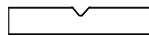

45° DOUBLE BEVEL

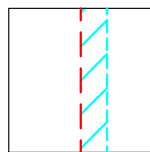

45° SINGLE BEVEL

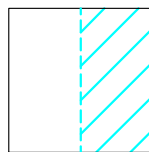

EDGE BEVEL

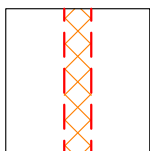
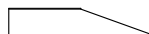

CAVITY

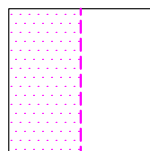

REMOVE PAPER

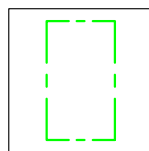

REFERENCE/
OPTIONAL

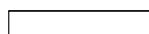

SYMBOLS

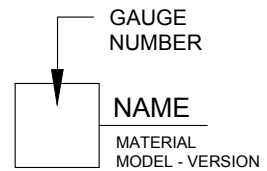
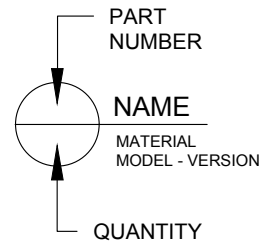

CENTER OF GRAVITY (CG)



FT Mini Commuter: Wood Parts



HOBBY GRADE PLYWOOD
1/16" (1.6 mm) THICK

FT MINI FIREWALL

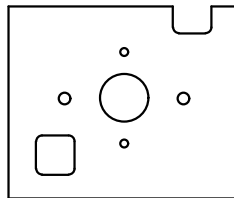

FT MINI CONTROL HORNS

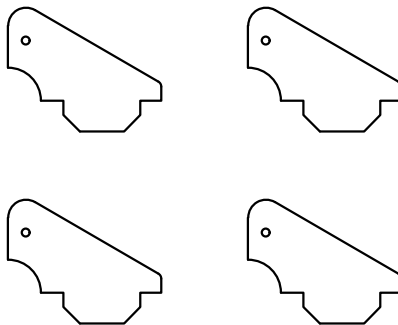

FT Mini Commuter

Designed By: Ben Harber
 Drawing By: Dan Sponholz
 Version: 1.0
 Date: 2019.06.30

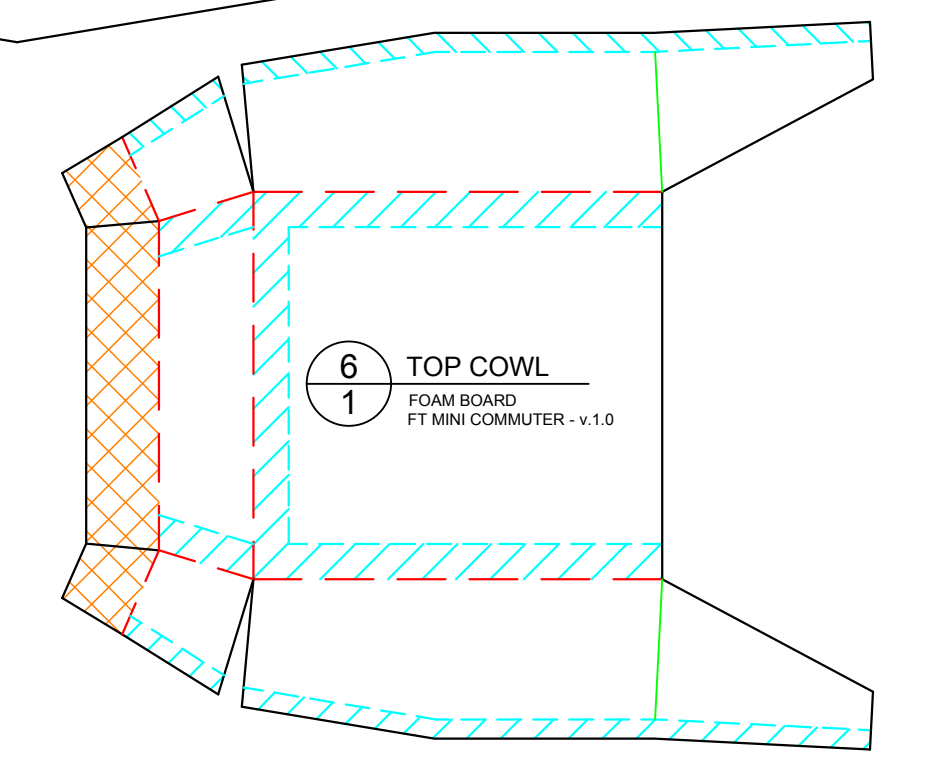
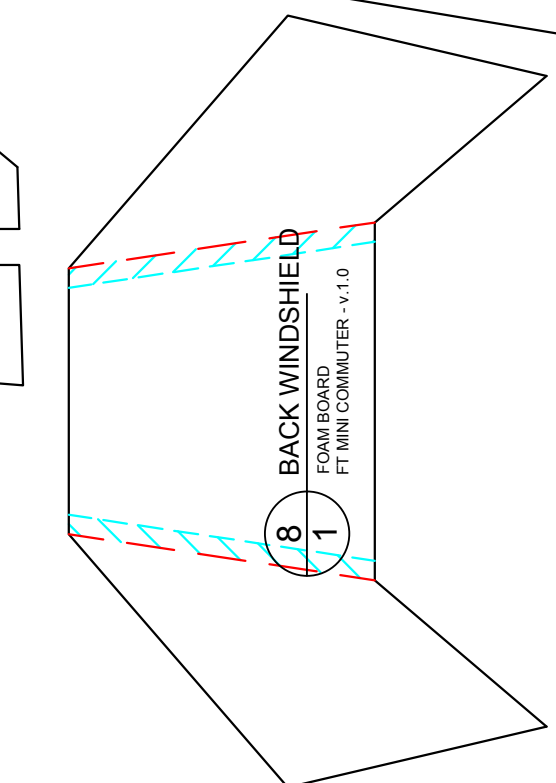
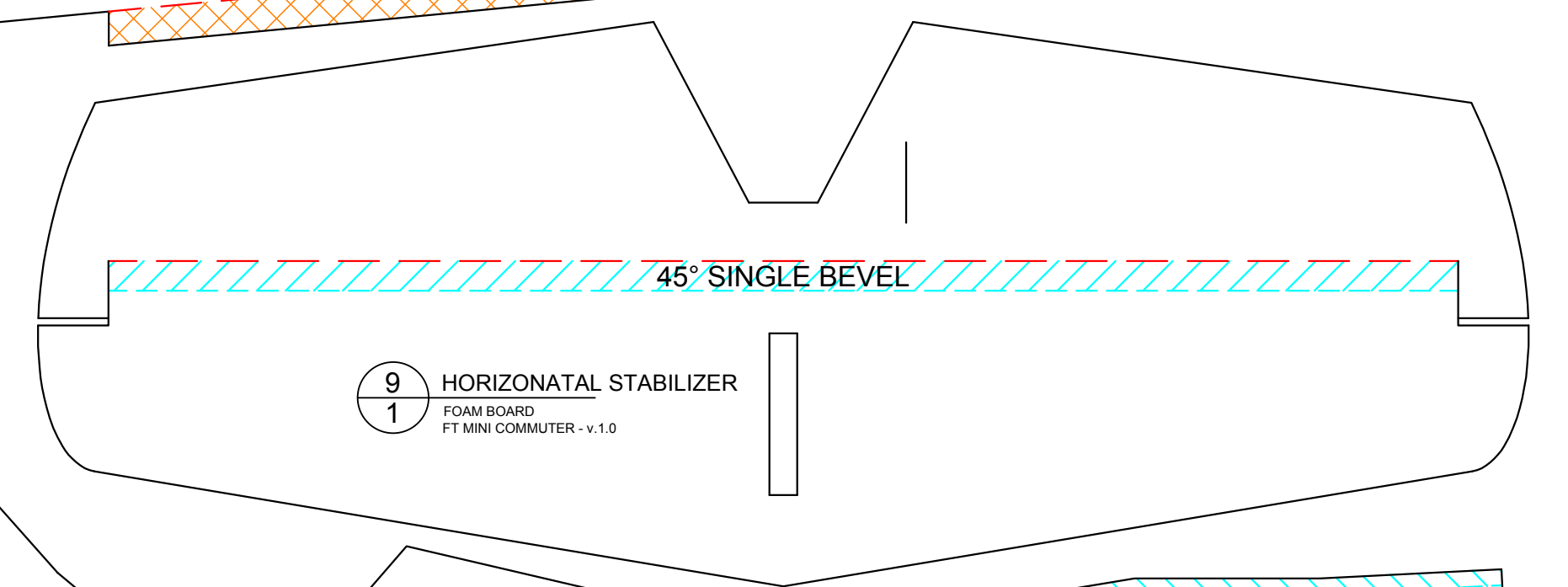
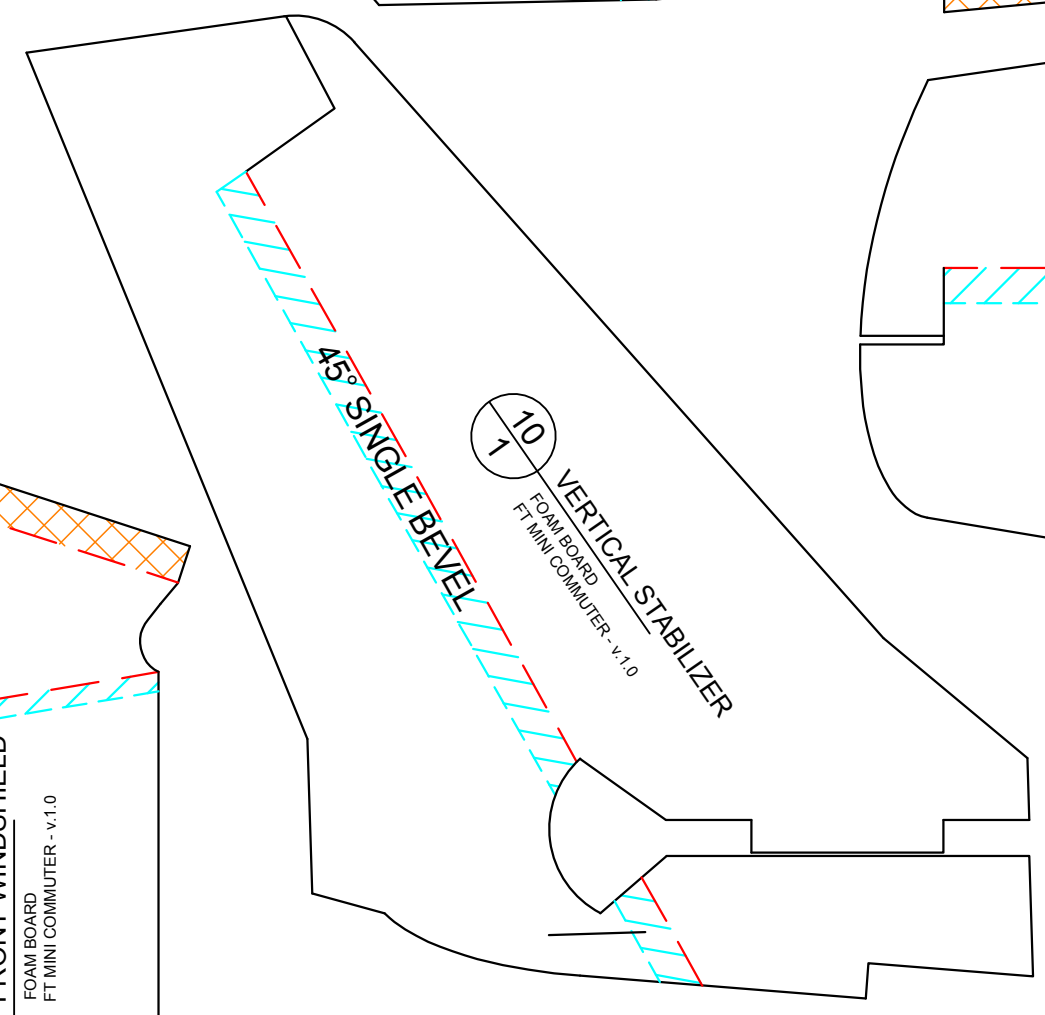
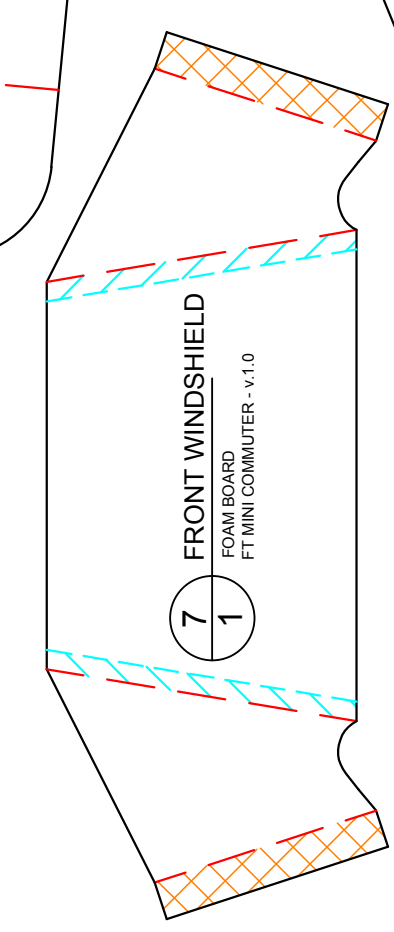
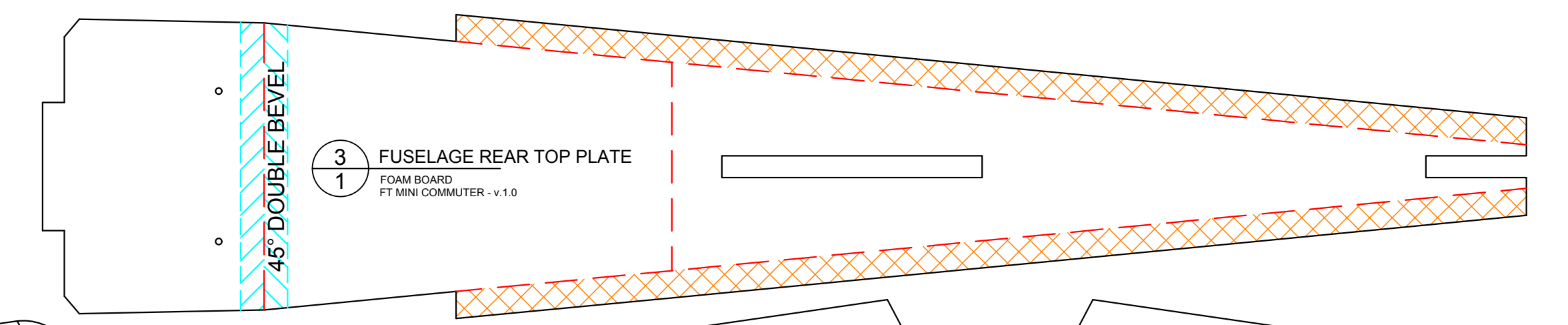
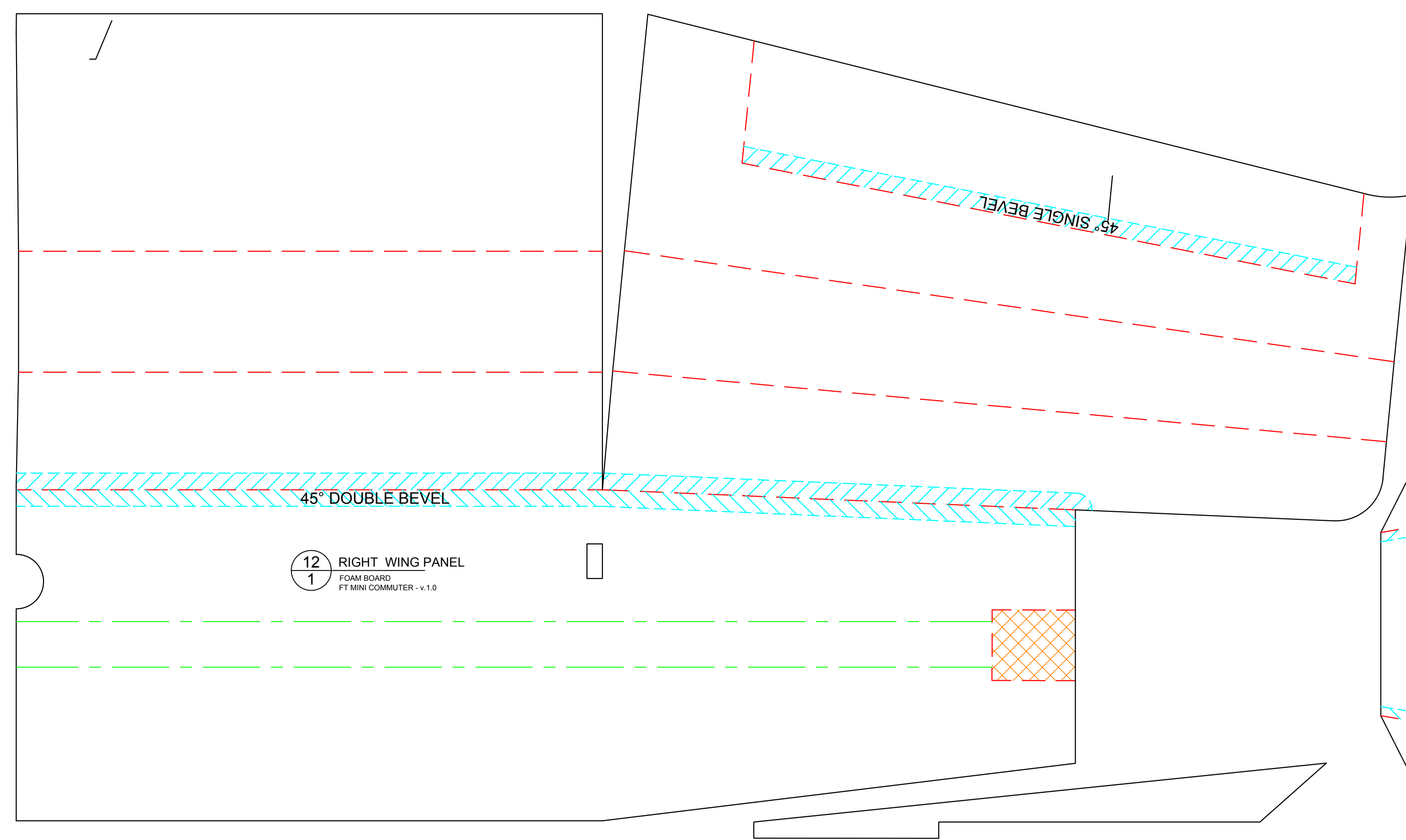
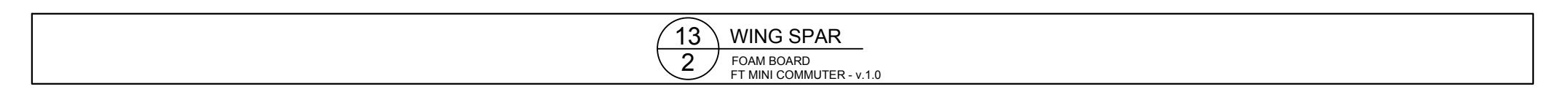
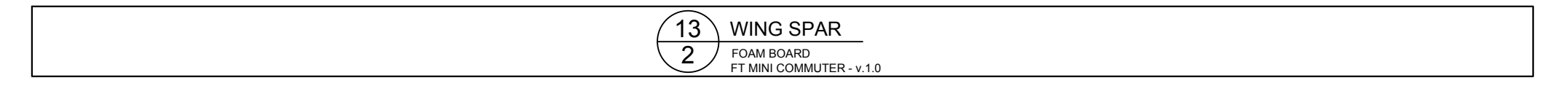
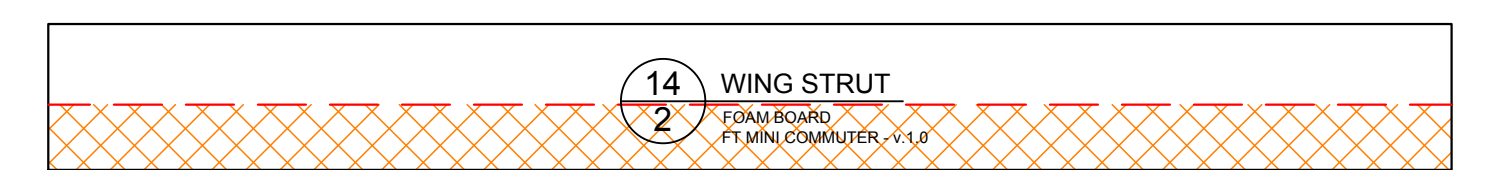
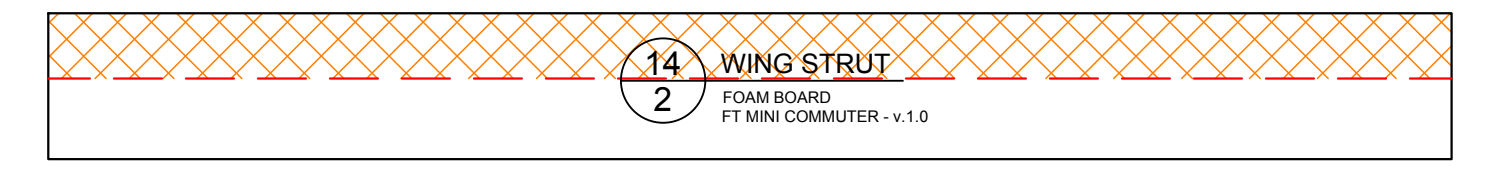
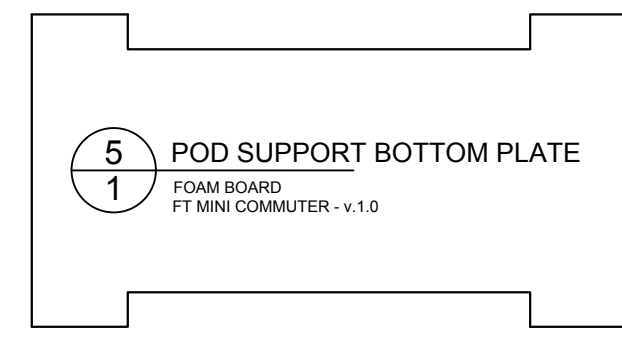
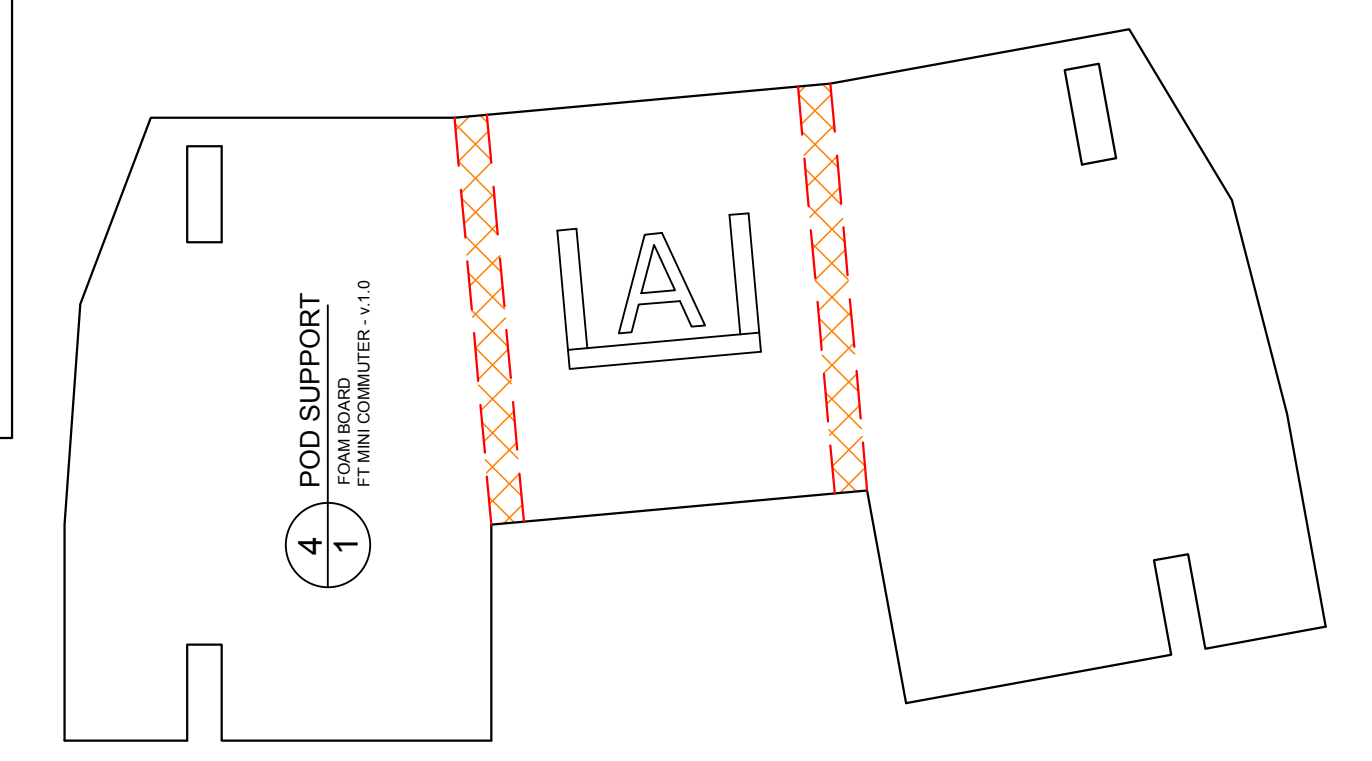
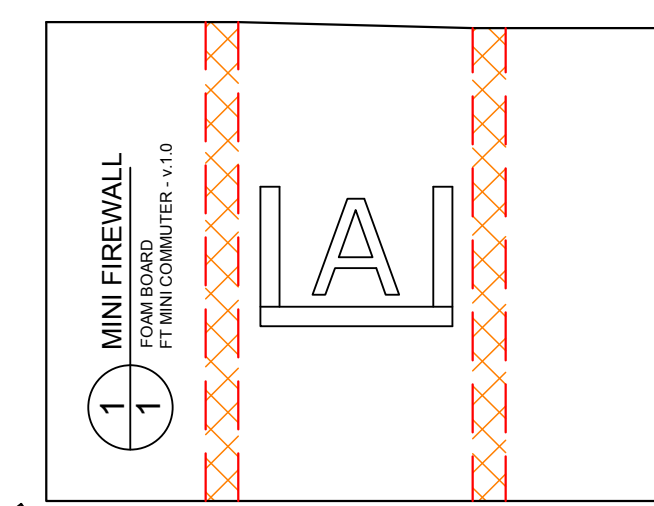
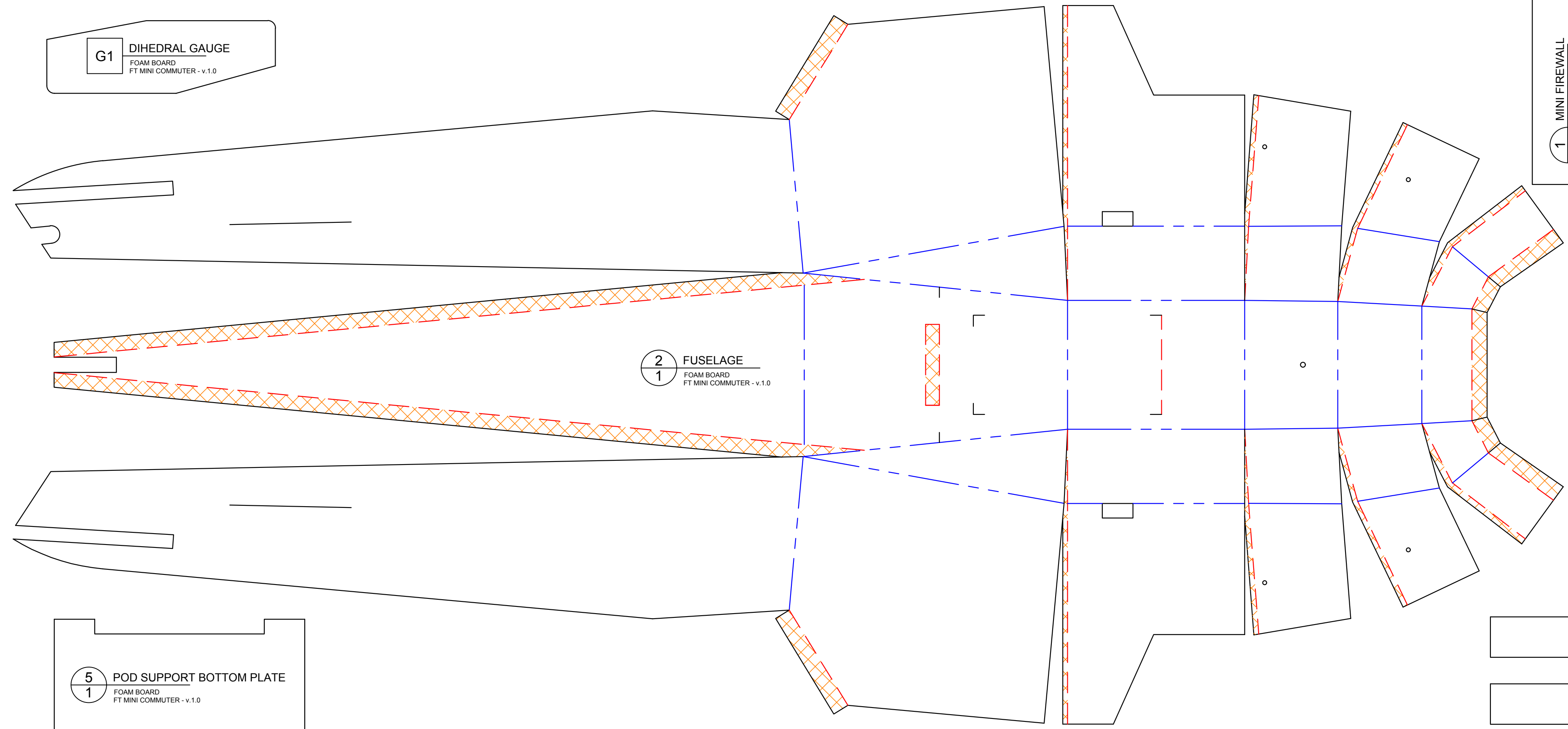
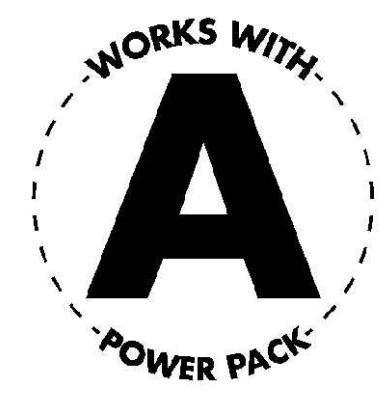
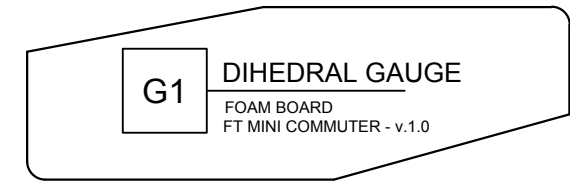

FT Mini Commuter

Designed By: Ben Harber
Drawing By: Dan Sponholz
Version: 1.0
Date: 2019.06.30

