

19 11/16"

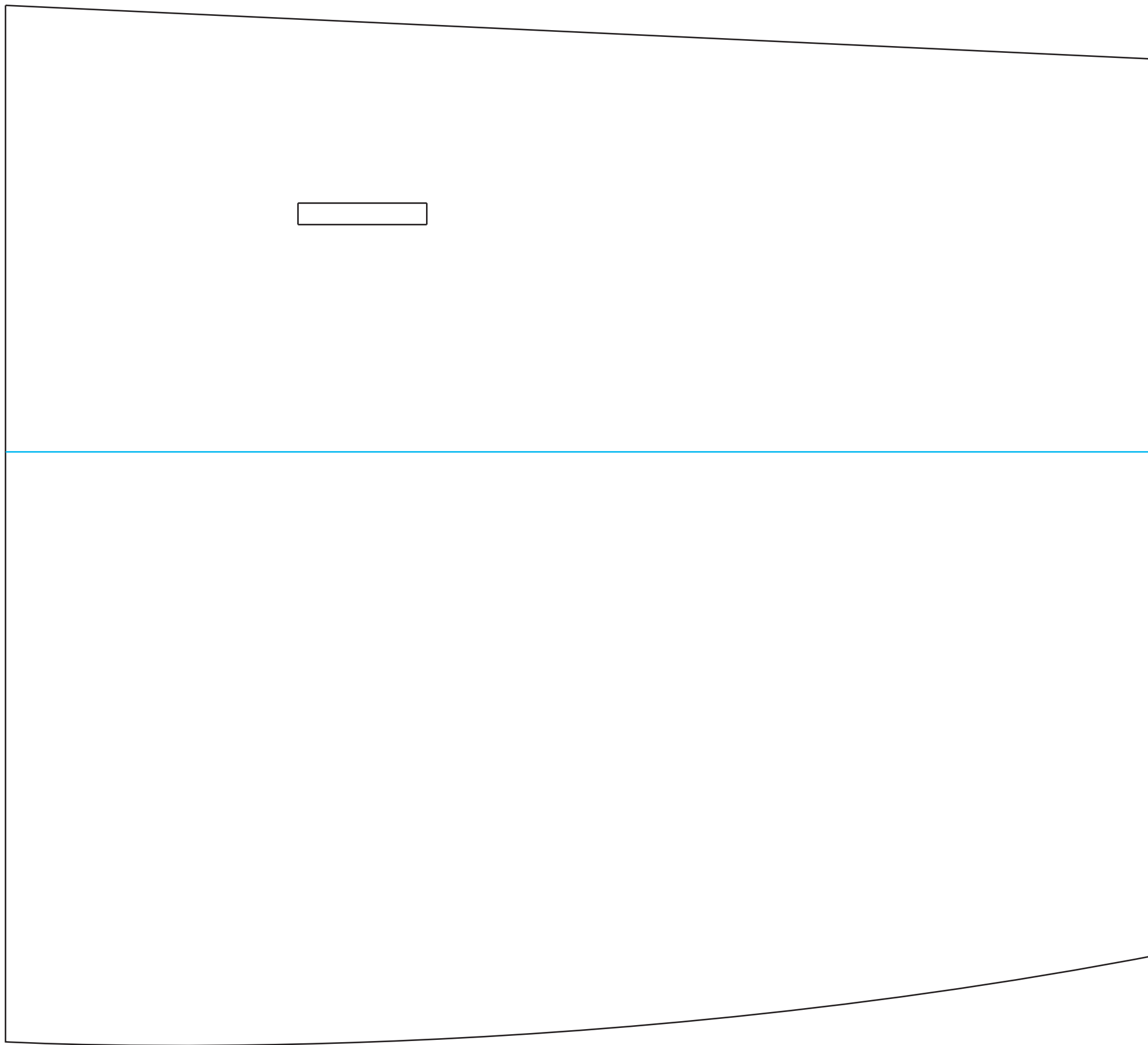

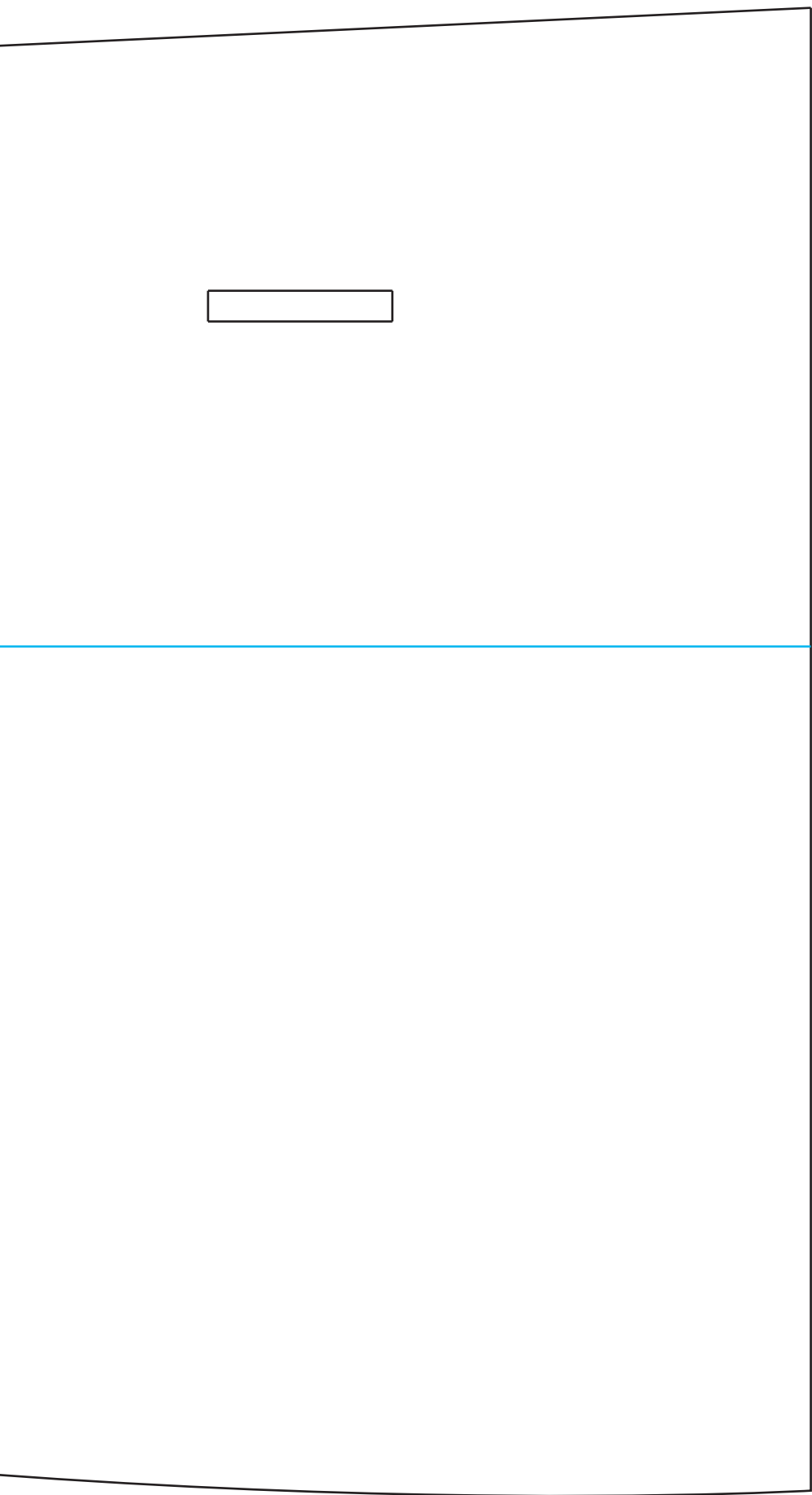

$1/64 = .0156$	$3/16 = .1875$	$5/8 = .625$
$1/32 = .0312$	$1/4 = .25$	$11/16 = .6875$
$3/64 = .0468$	$5/16 = .3125$	$3/4 = .75$
$1/16 = .0625$	$3/8 = .375$	$13/16 = .8125$
$3/32 = .0937$	$7/16 = .4375$	$7/8 = .875$
$1/8 = .125$	$1/2 = .5$	$15/16 = .9375$
$5/32 = .1562$	$9/16 = .5625$	

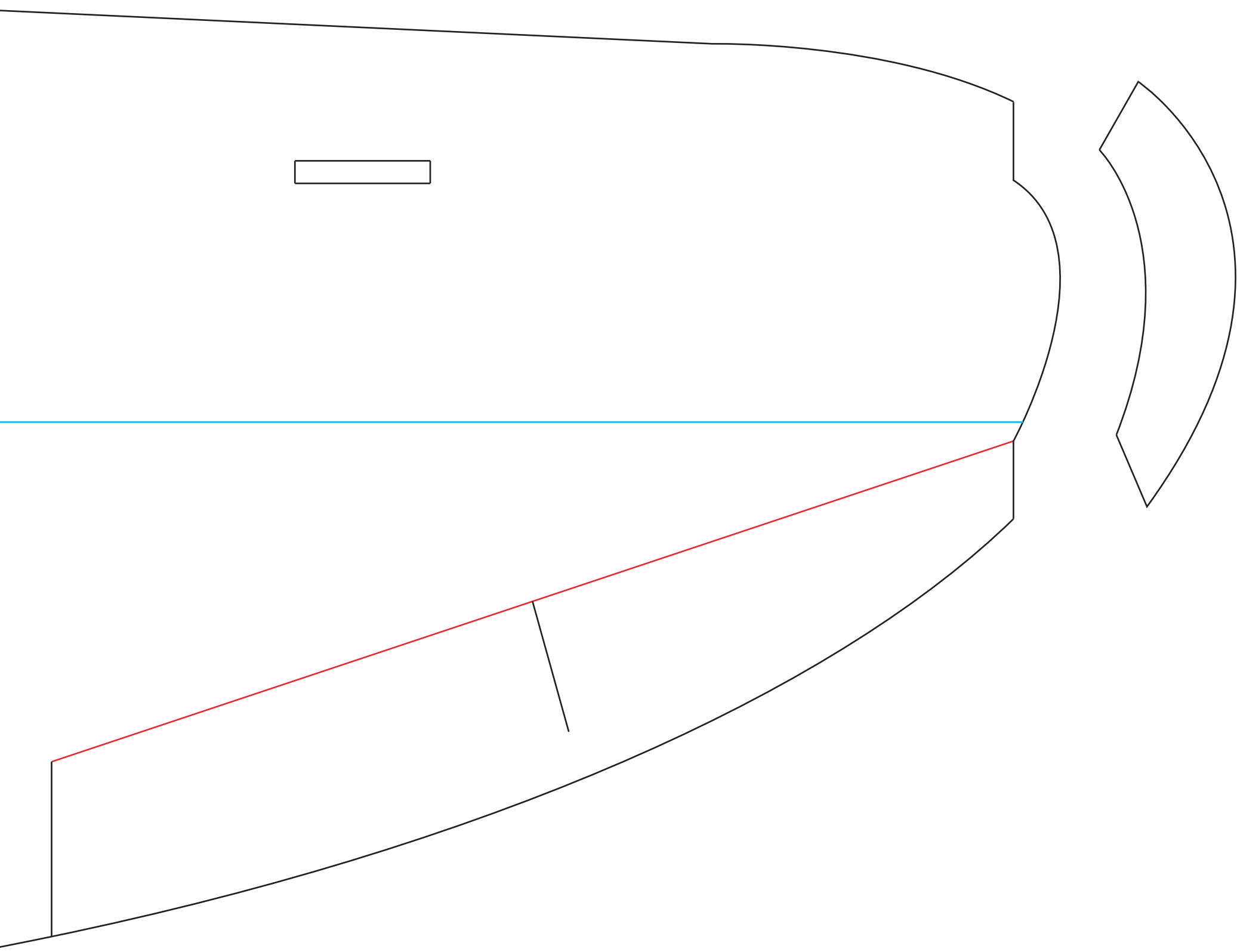
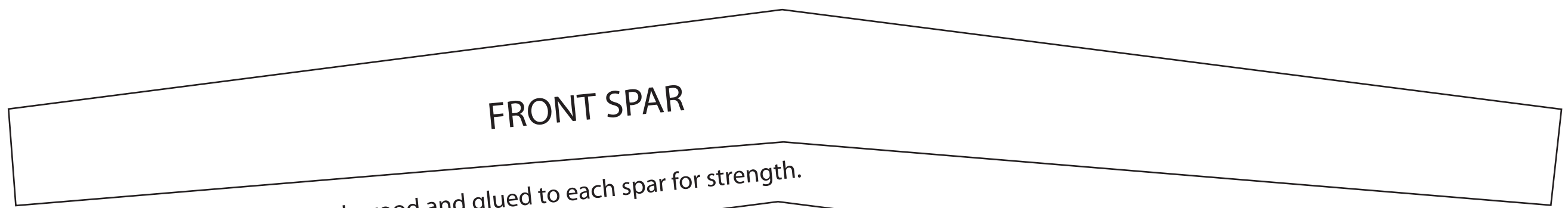
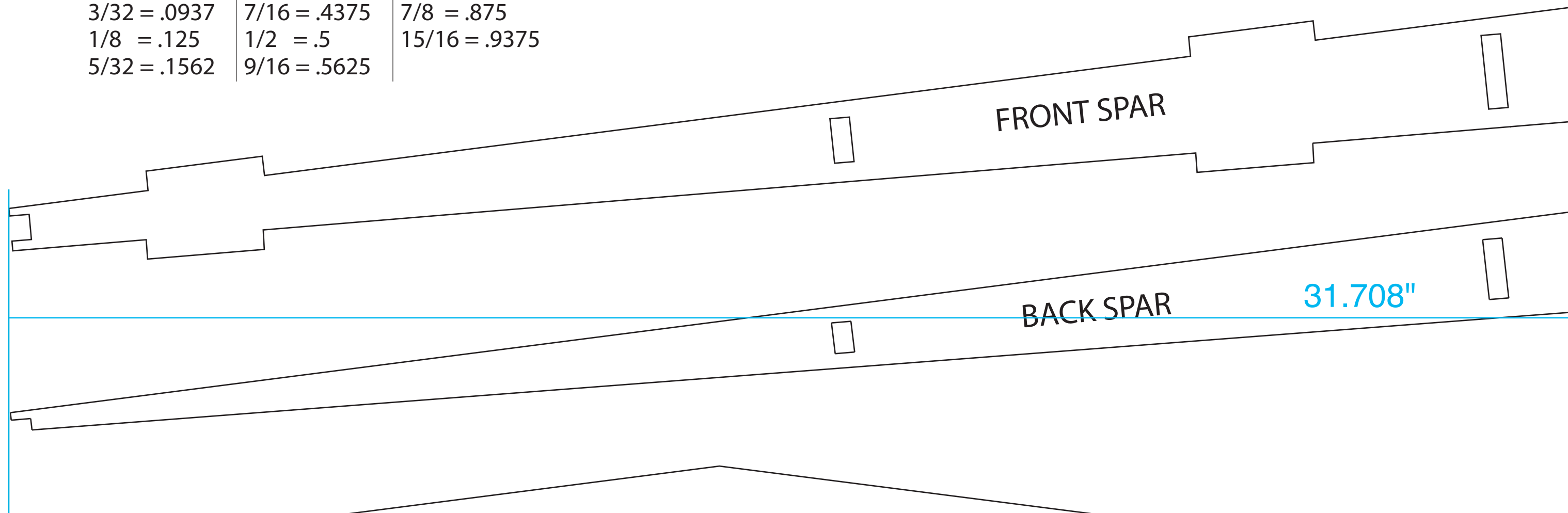

These are made from 1/8" Hobby plywood and glued to each spar for strength.

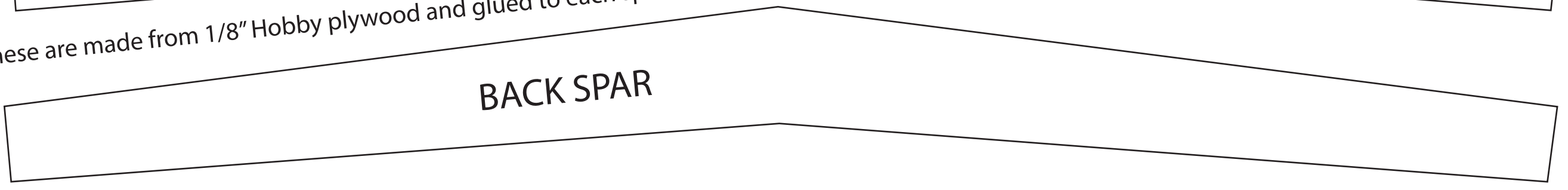

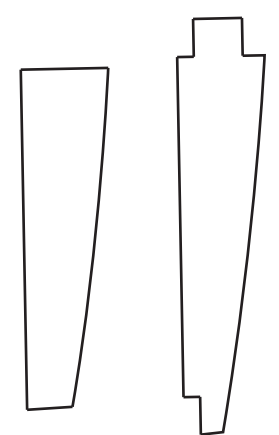
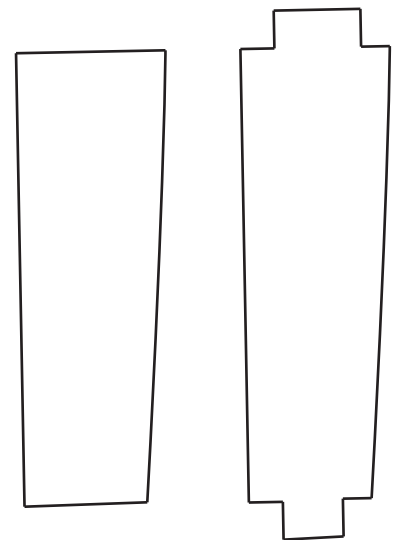
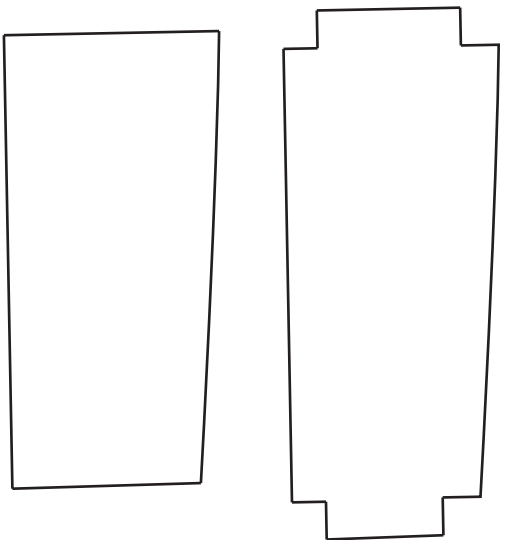

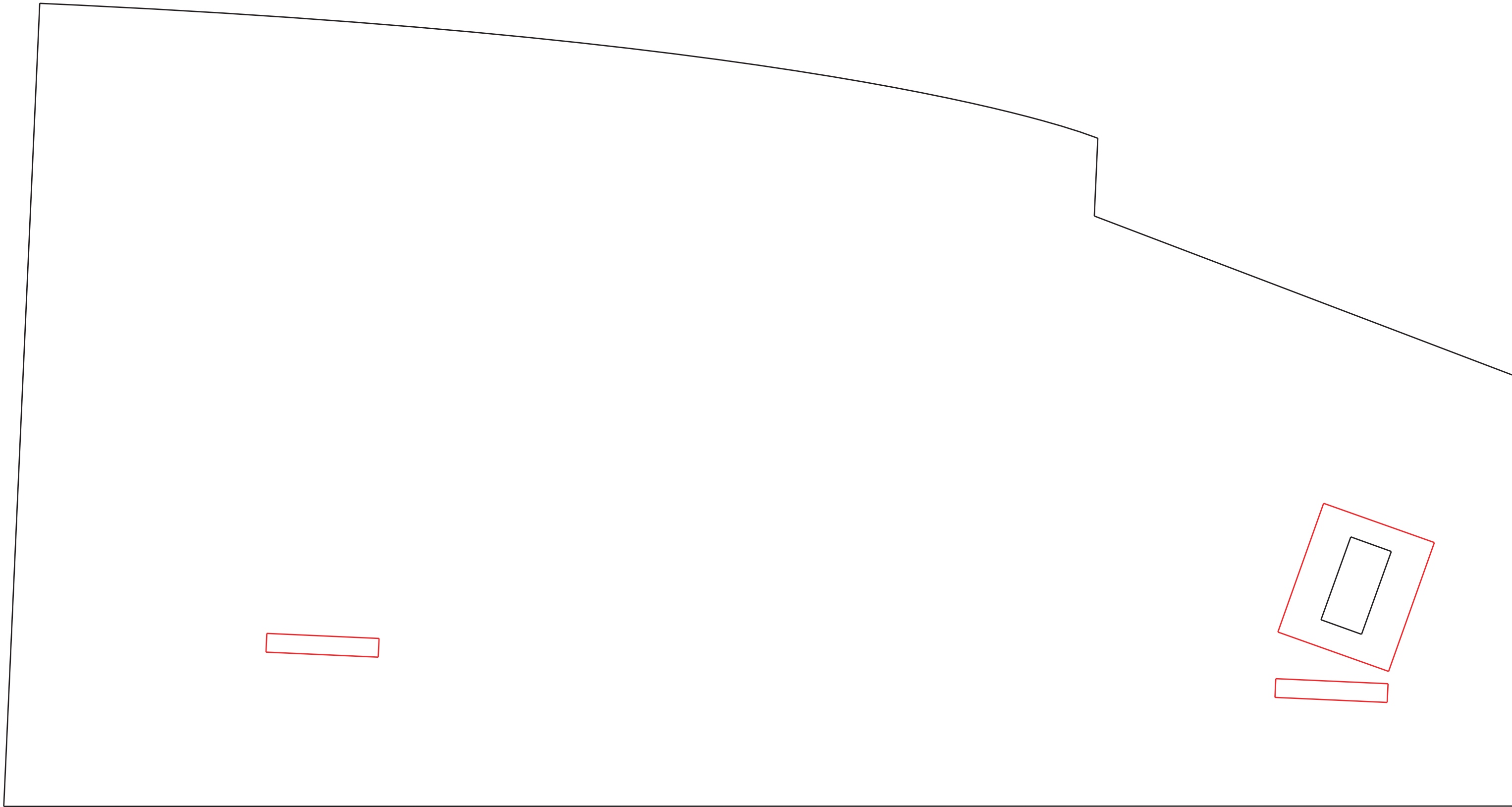

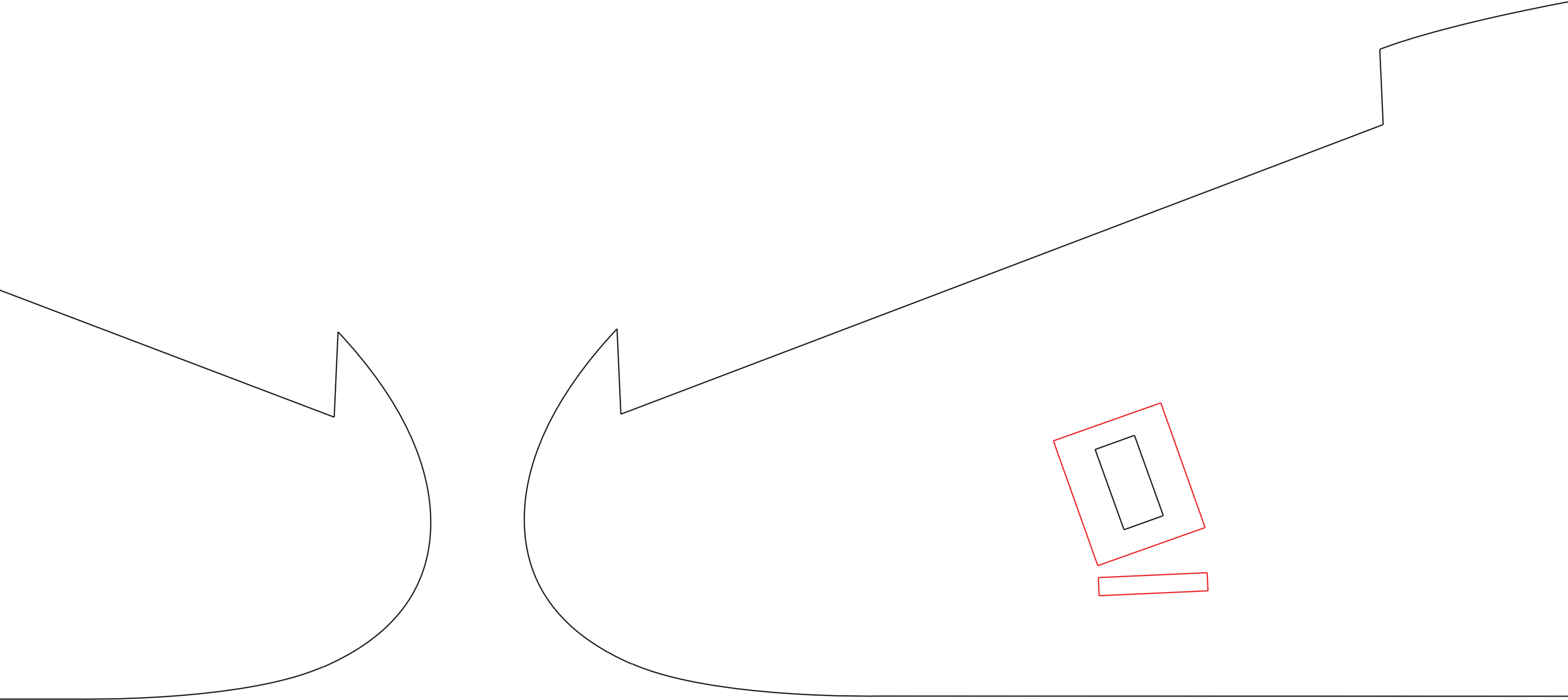

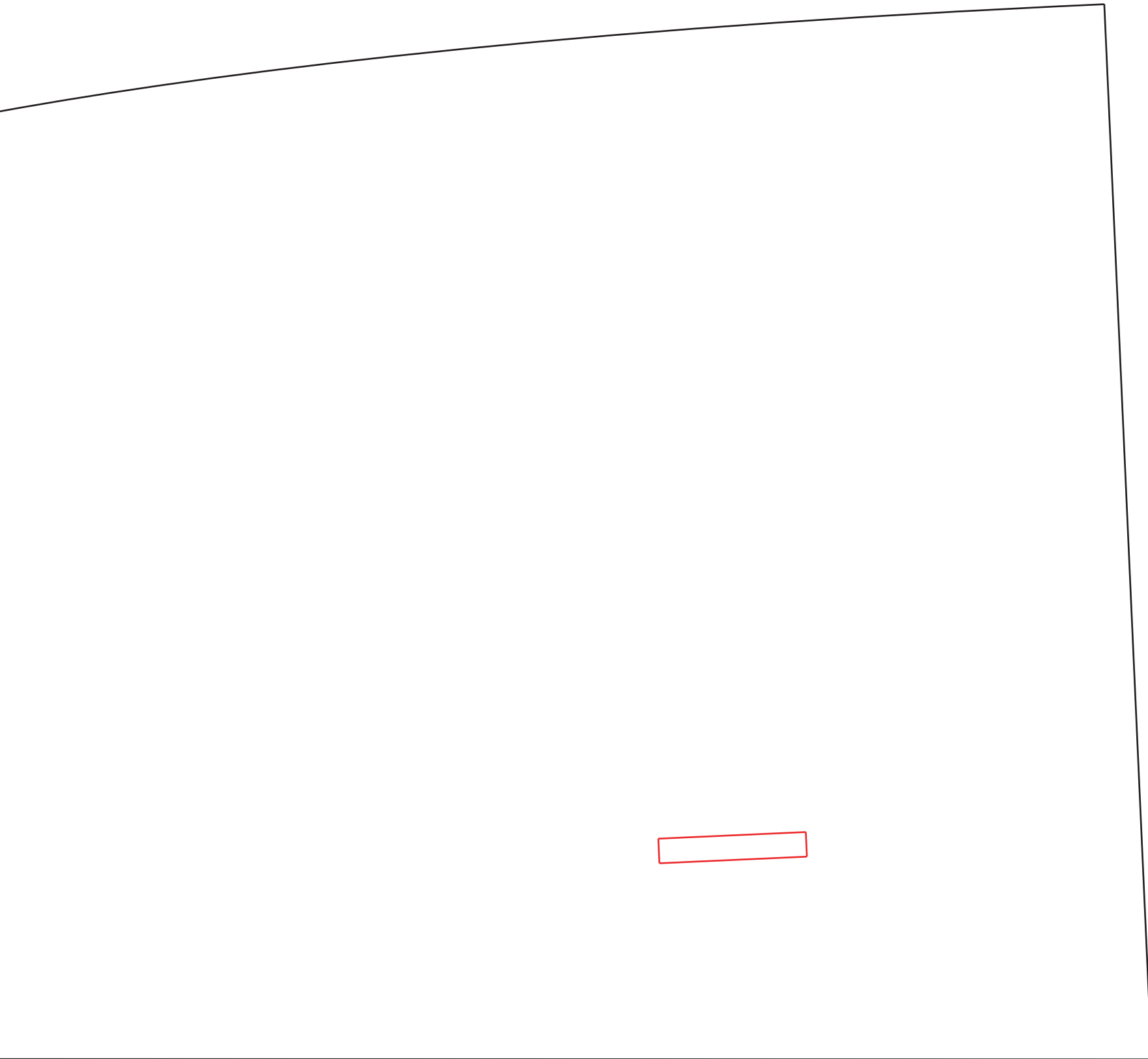

This piece is used on the hatch for structural support and is glued in the center of the hatch.

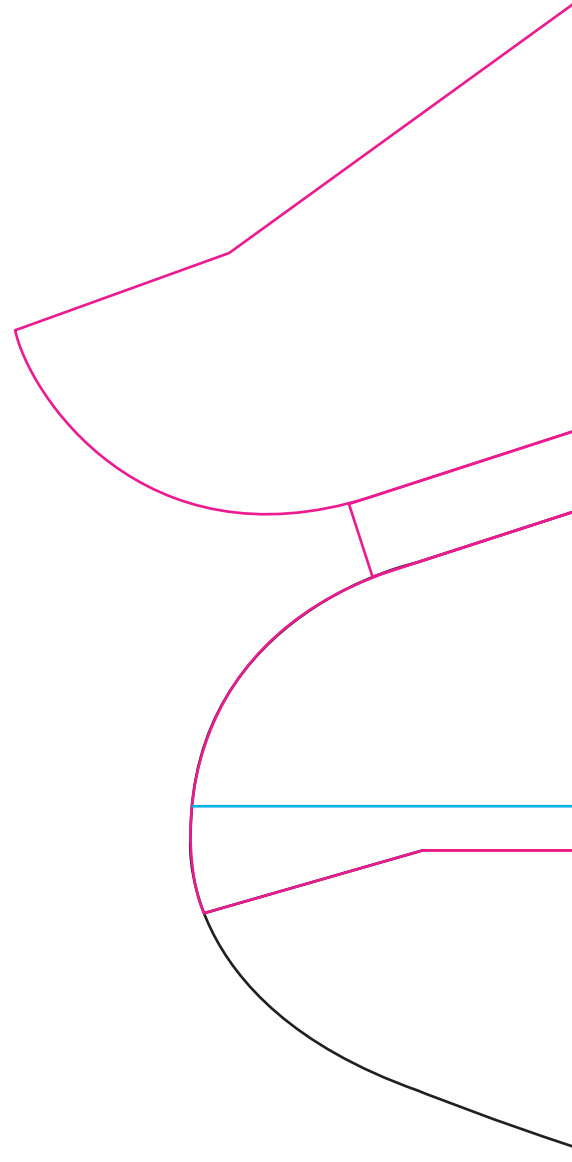
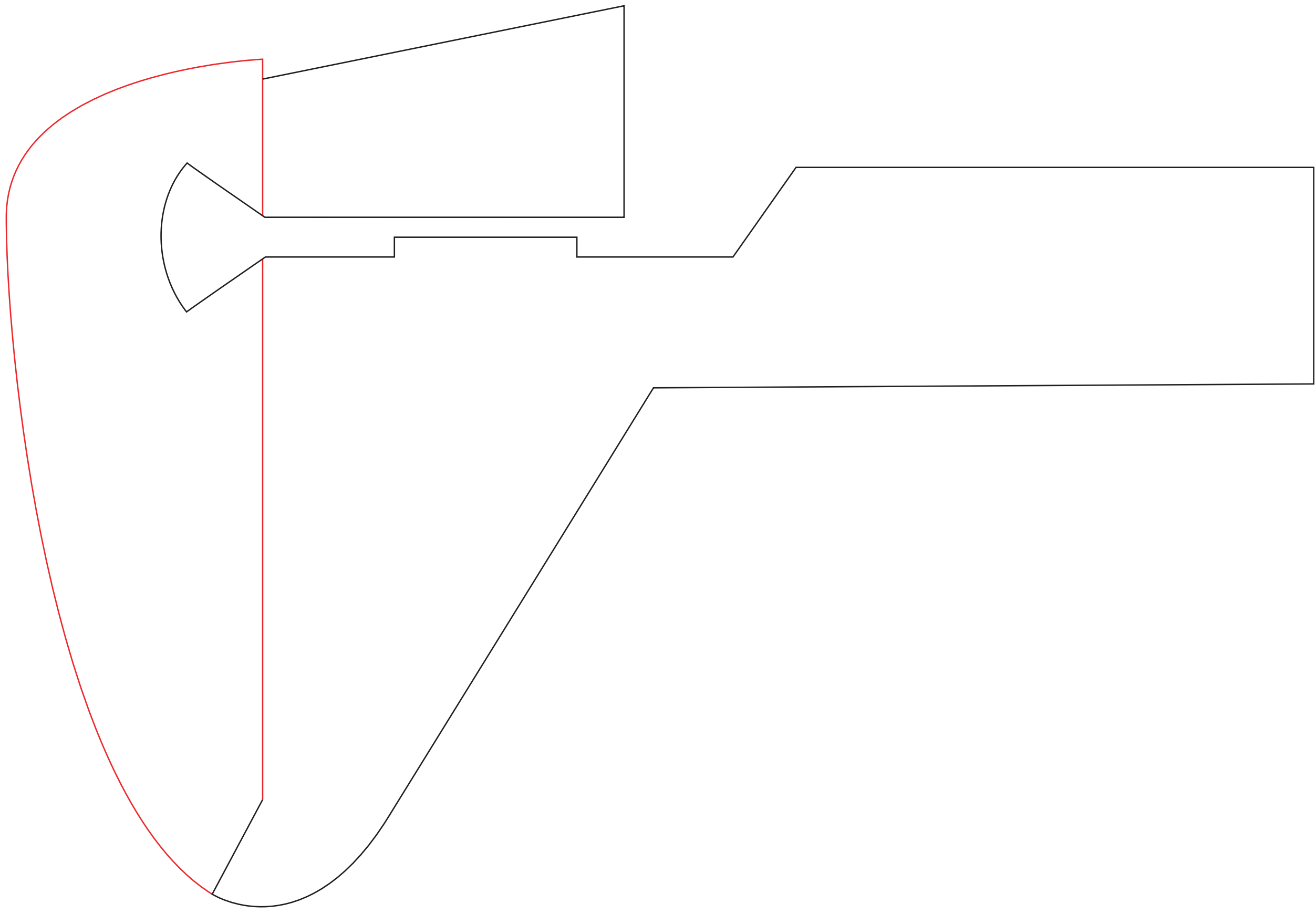

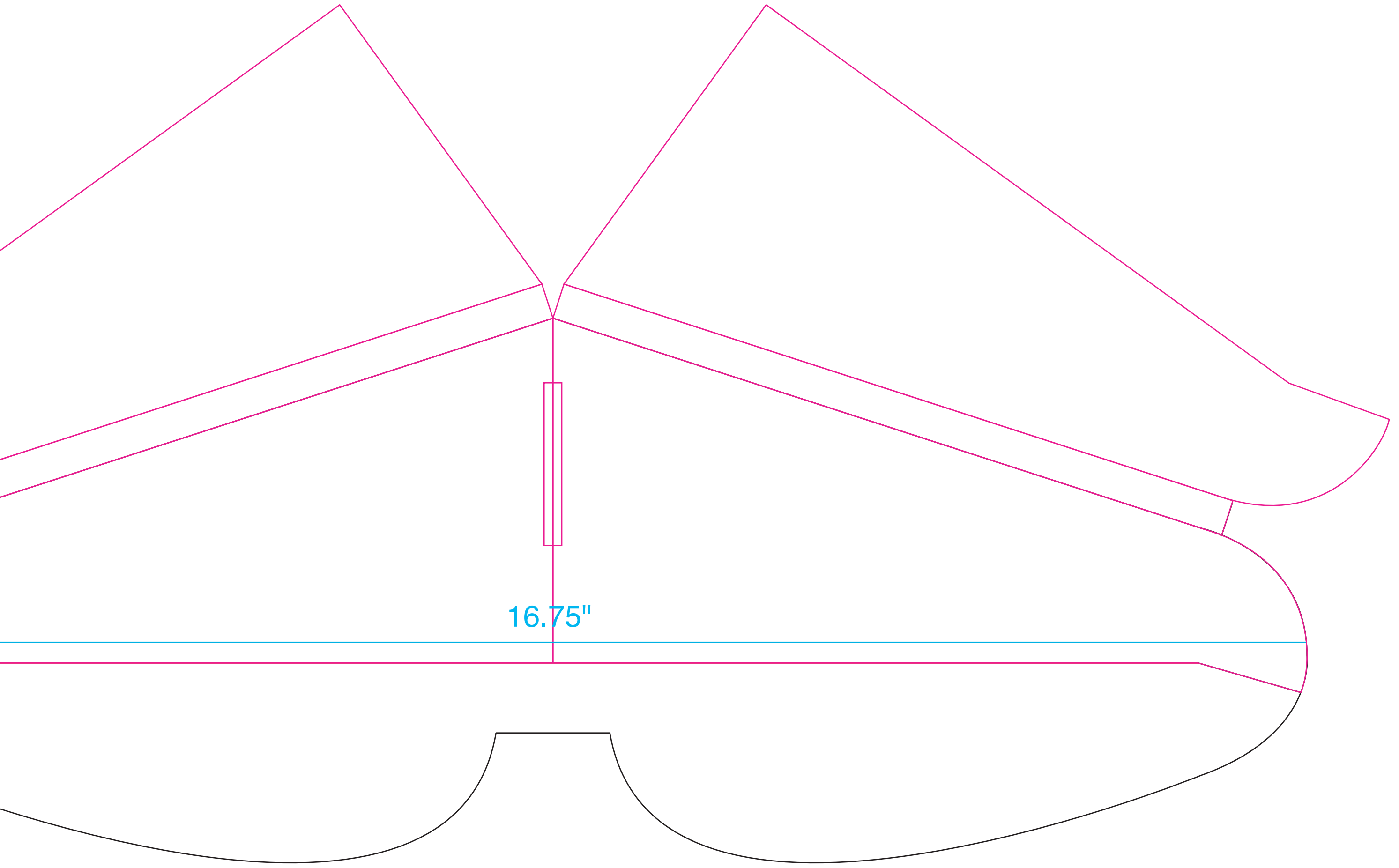

16.75"

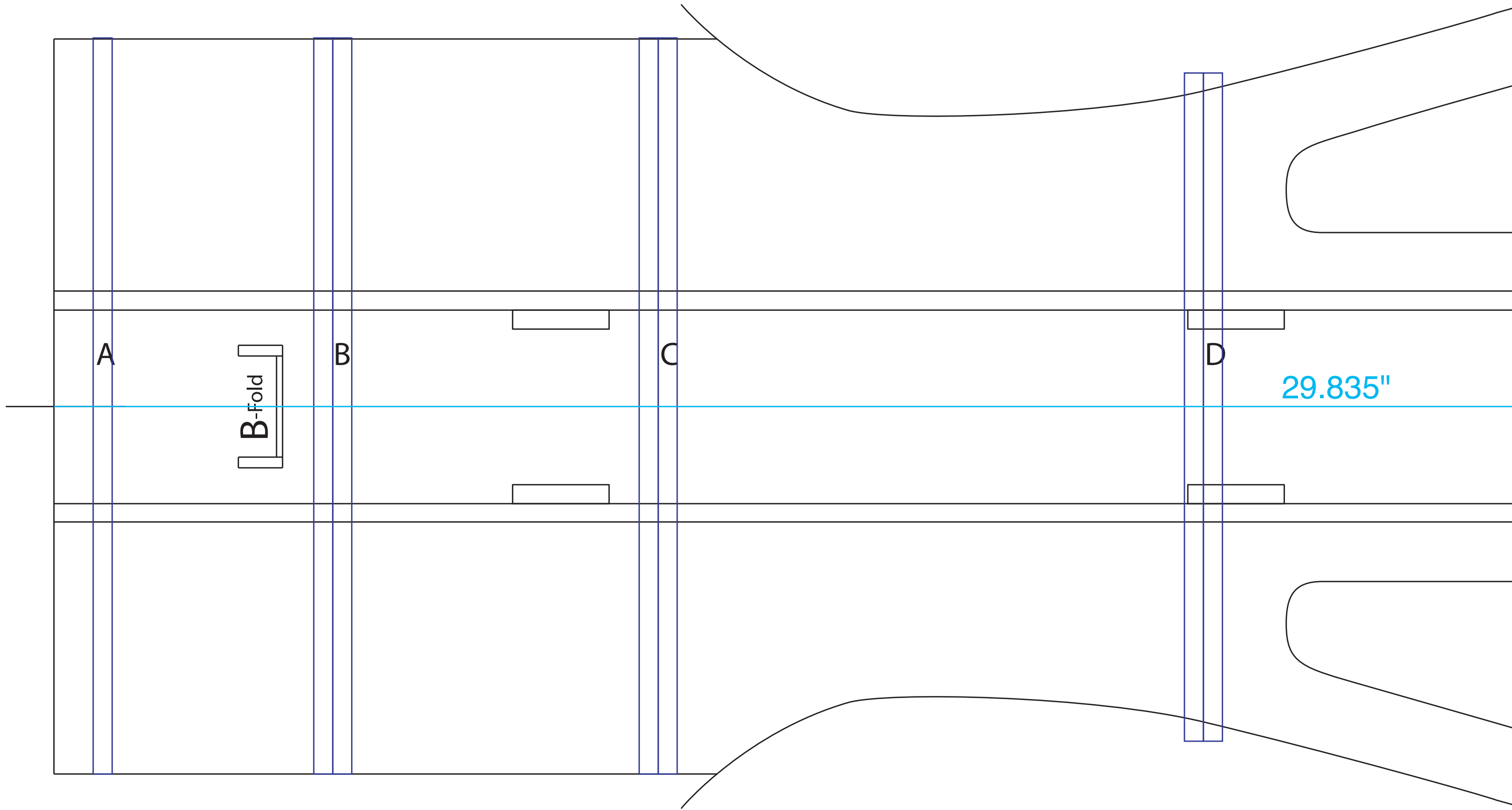

A

B-Fold

B

C

D

29.835"

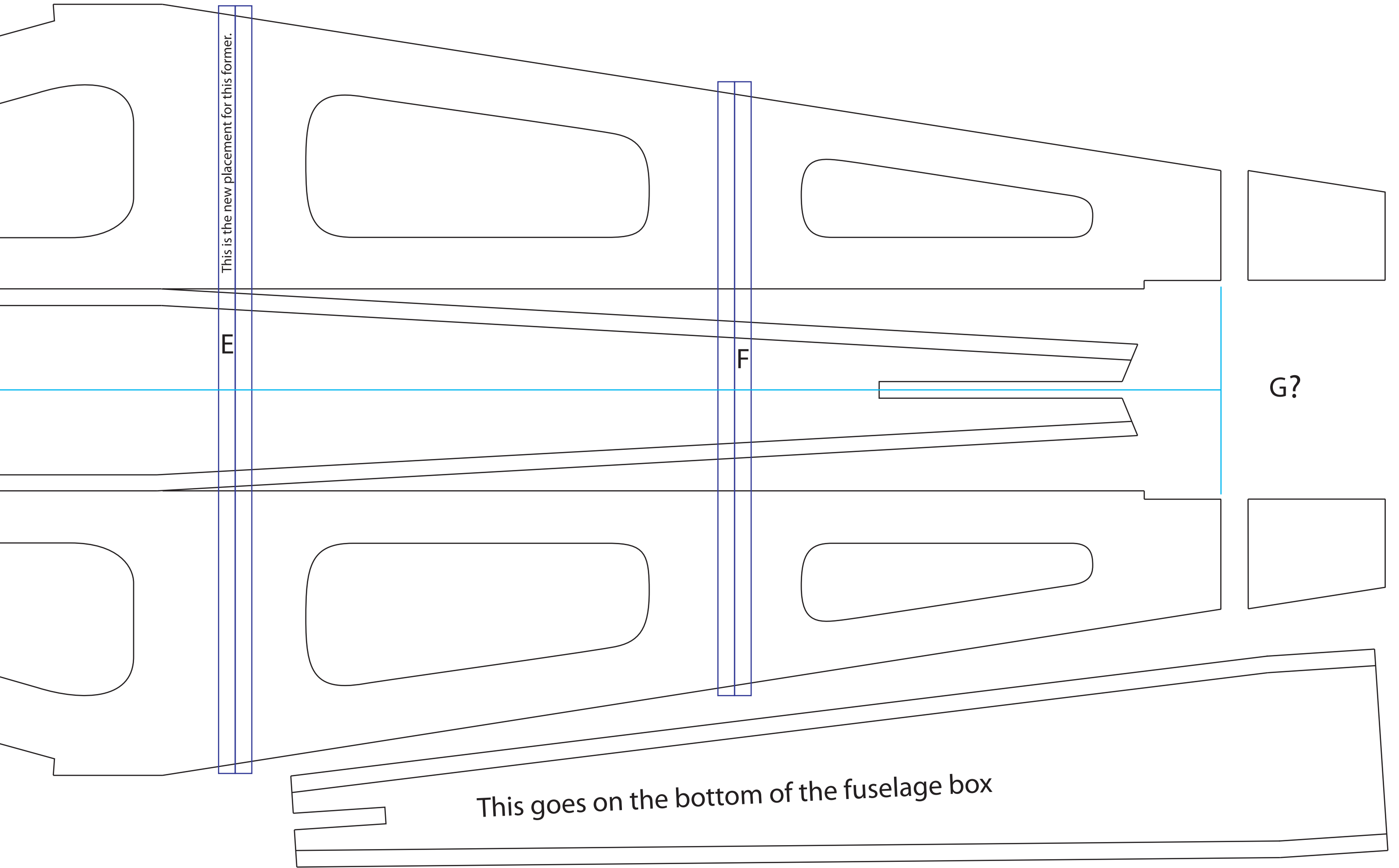

This is the new placement for this former.

F

F

G?

This goes on the bottom of the fuselage box

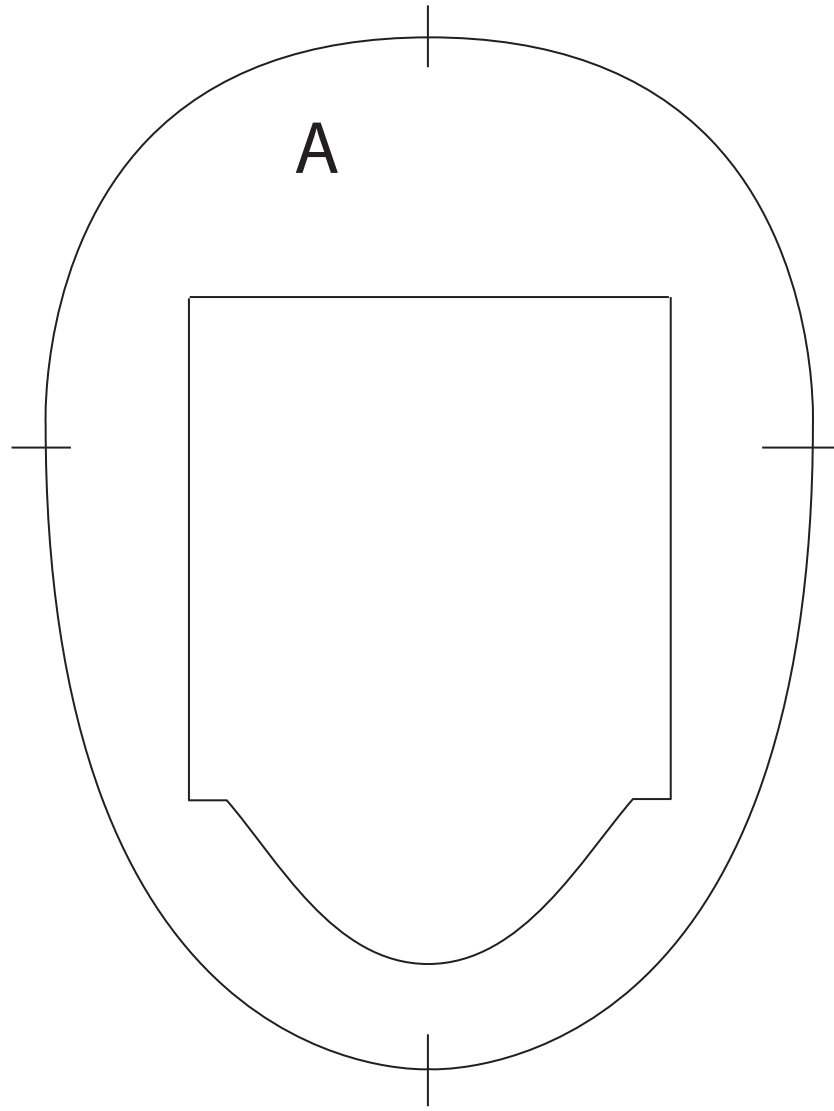

A

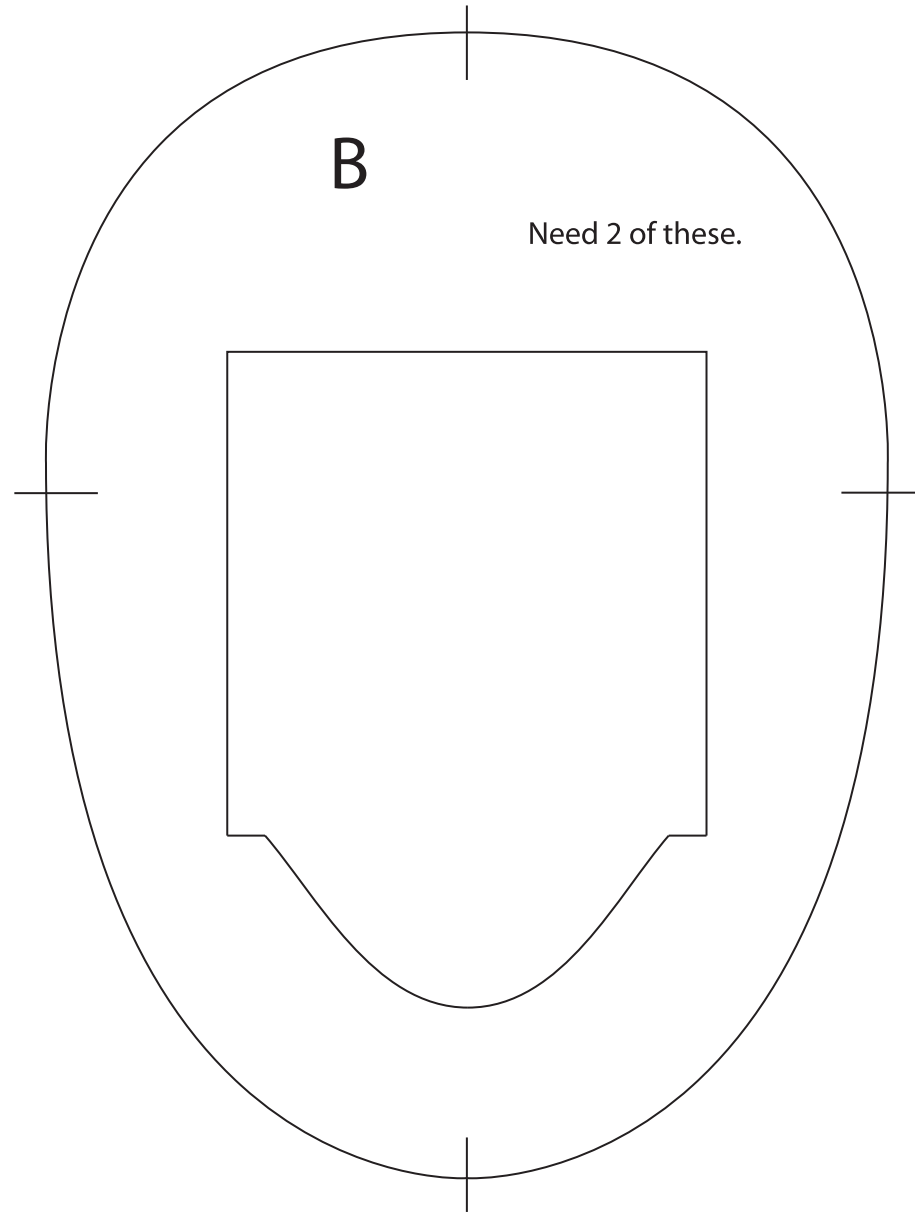

B

Need 2 of these.

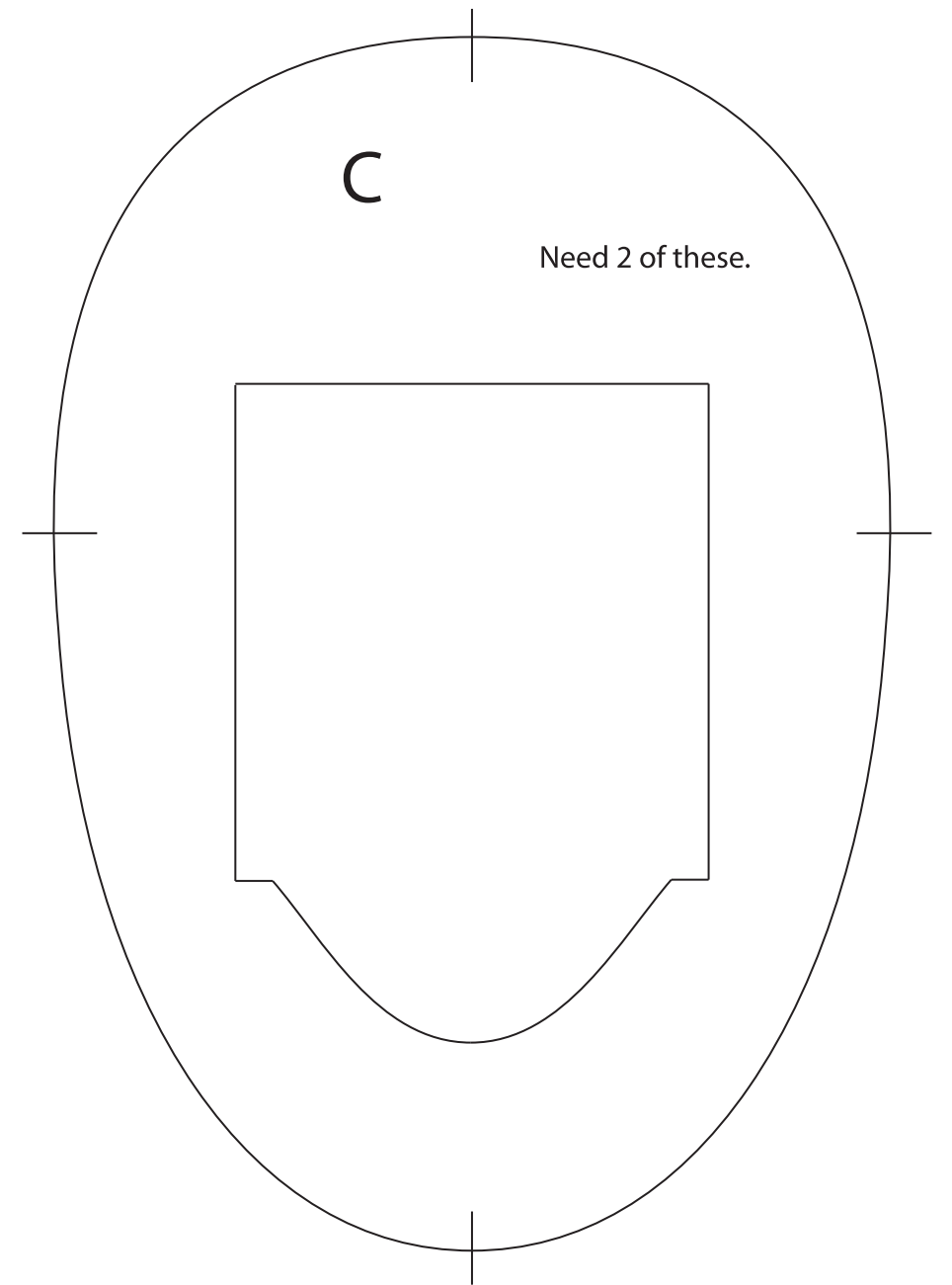

C

Need 2 of these.

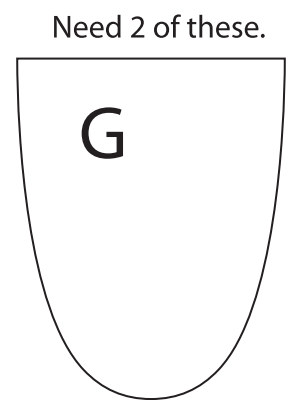
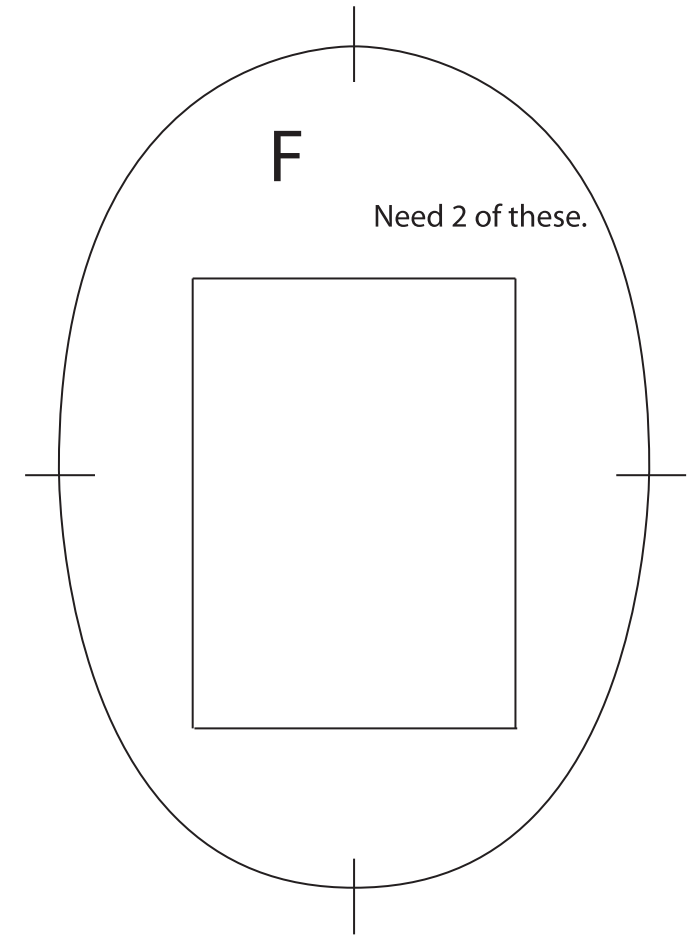
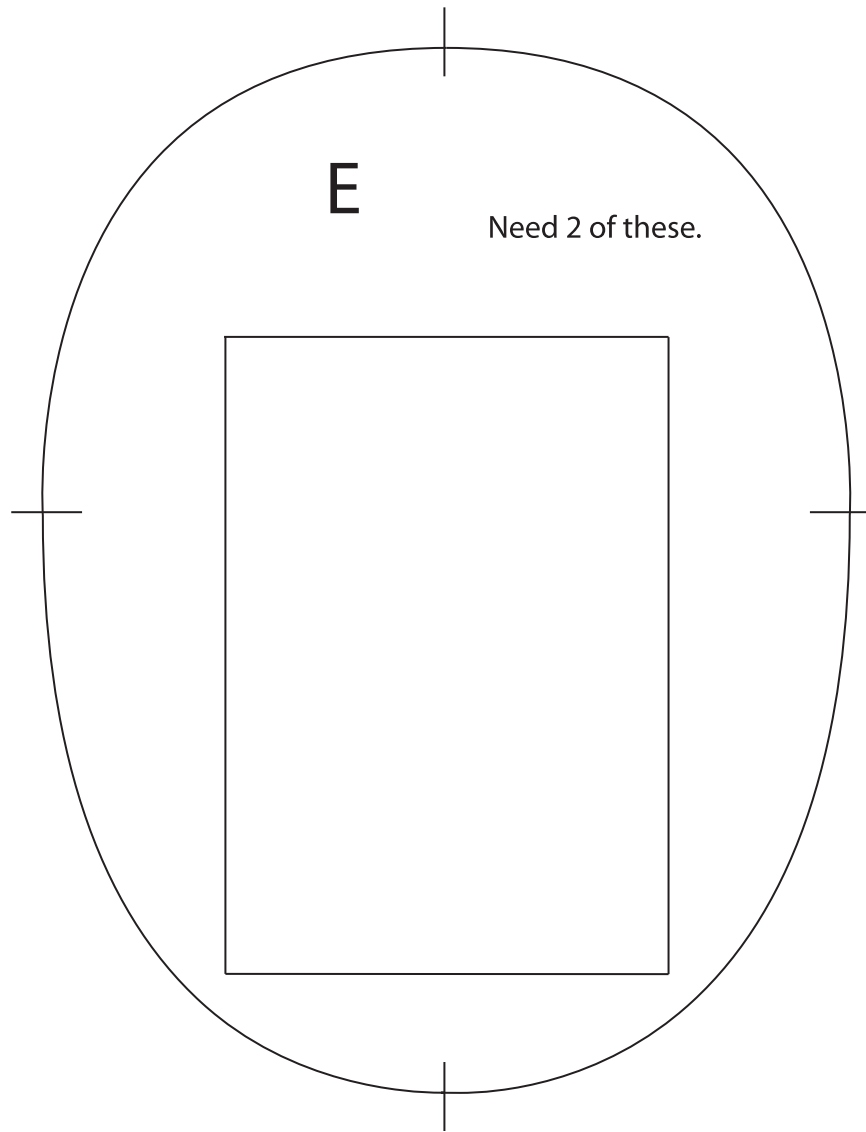
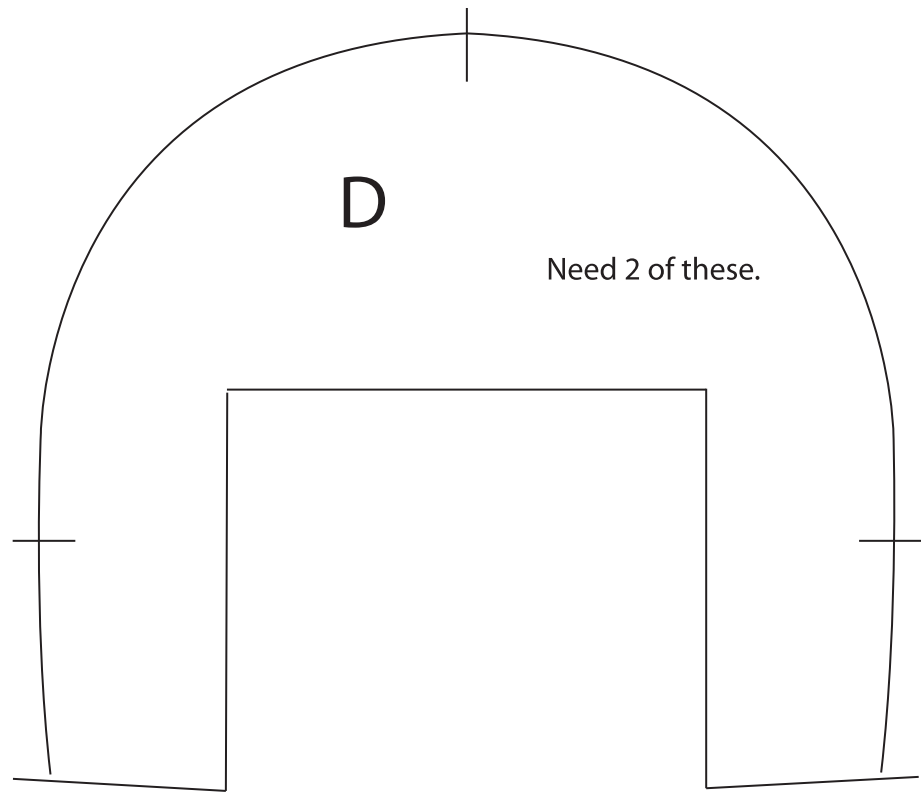

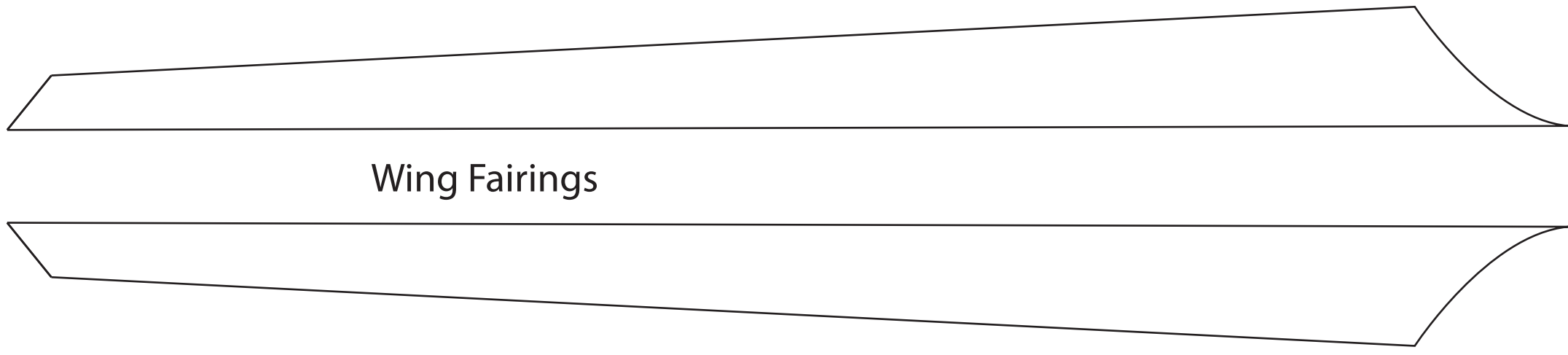

Wing Fairings

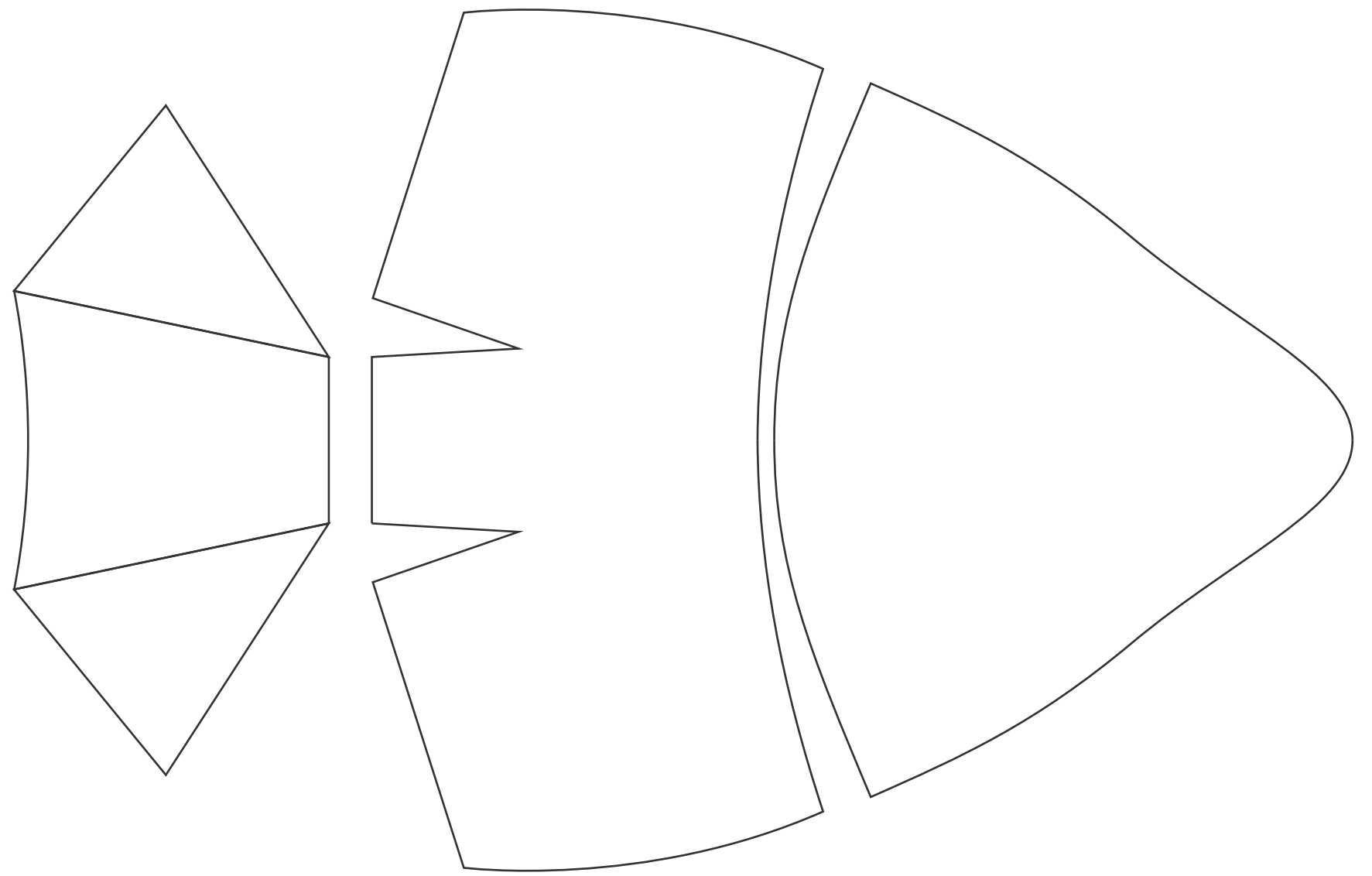

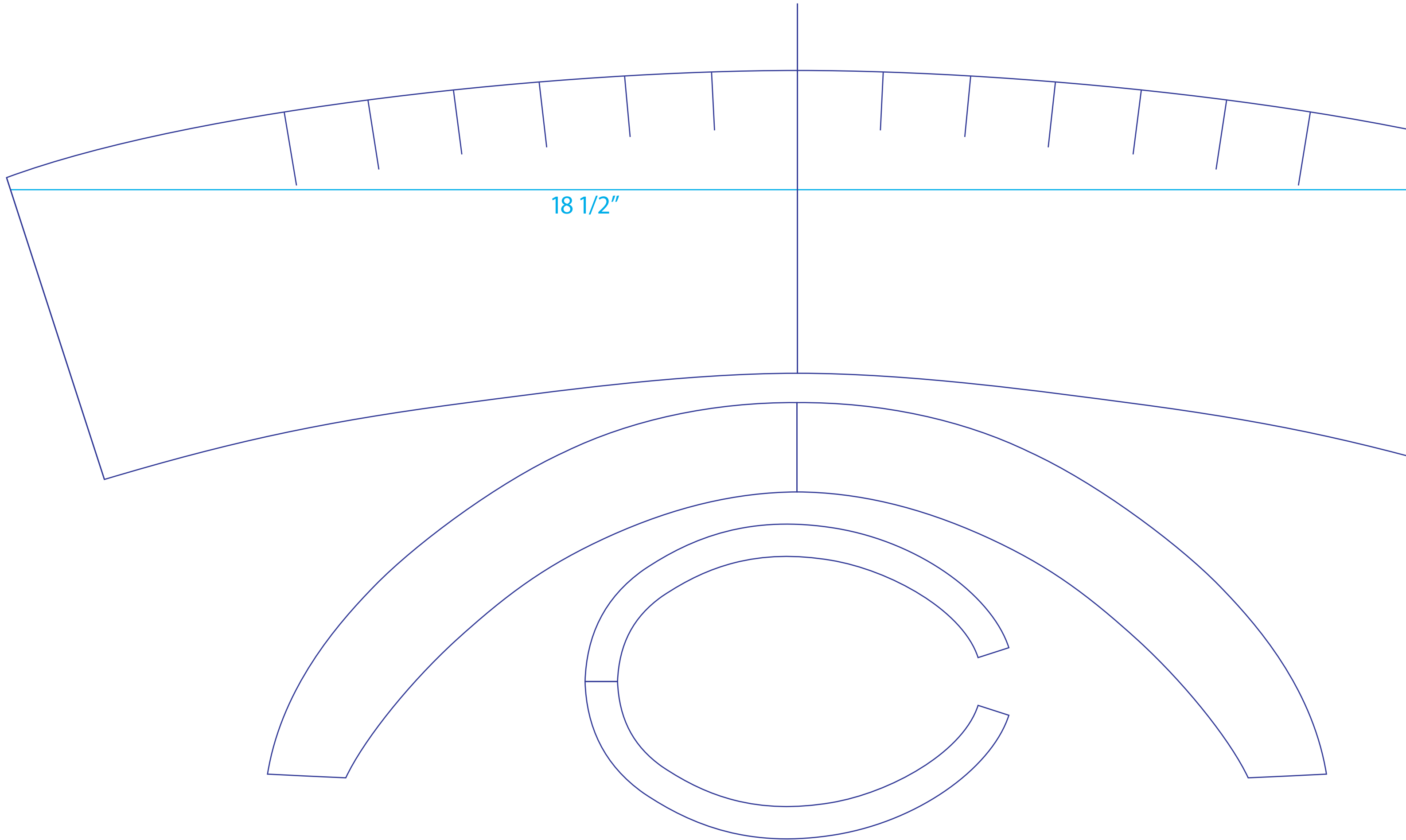

$18 \frac{1}{2}$ "

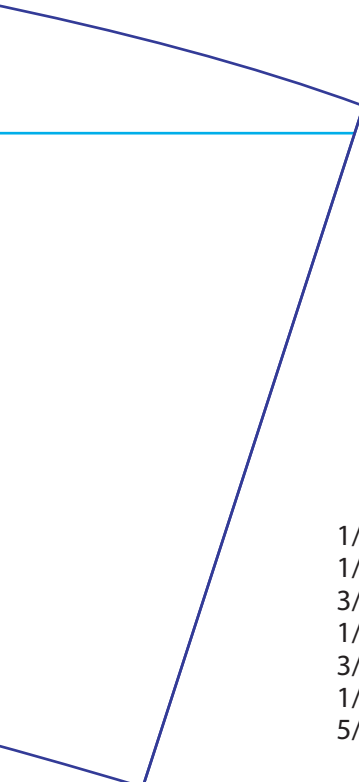

$1/64 = .0156$	$3/16 = .1875$	$5/8 = .625$
$1/32 = .0312$	$1/4 = .25$	$11/16 = .6875$
$3/64 = .0468$	$5/16 = .3125$	$3/4 = .75$
$1/16 = .0625$	$3/8 = .375$	$13/16 = .8125$
$3/32 = .0937$	$7/16 = .4375$	$7/8 = .875$
$1/8 = .125$	$1/2 = .5$	$15/16 = .9375$
$5/32 = .1562$	$9/16 = .5625$	



19 7/8"

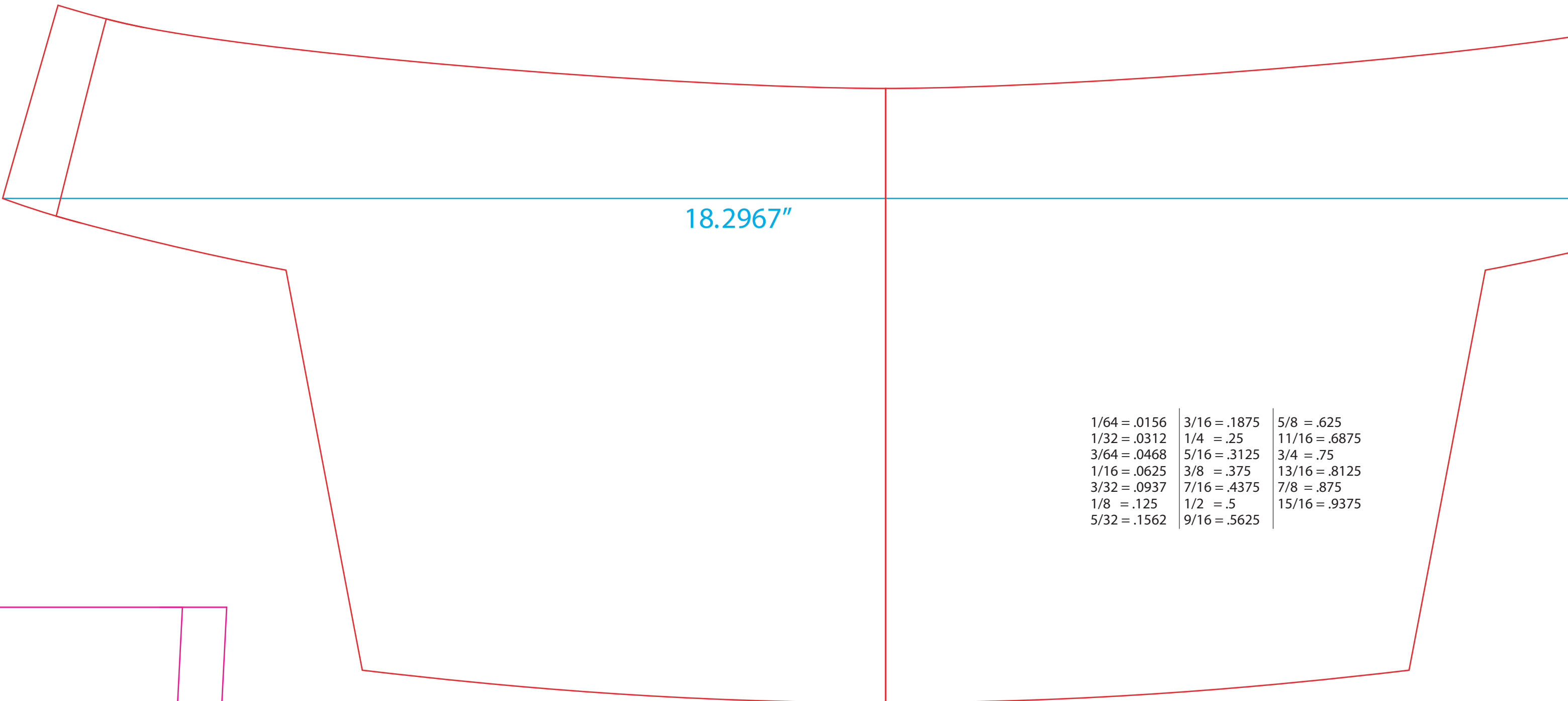

18.2967"

1/64 = .0156	3/16 = .1875	5/8 = .625
1/32 = .0312	1/4 = .25	11/16 = .6875
3/64 = .0468	5/16 = .3125	3/4 = .75
1/16 = .0625	3/8 = .375	13/16 = .8125
3/32 = .0937	7/16 = .4375	7/8 = .875
1/8 = .125	1/2 = .5	15/16 = .9375
5/32 = .1562	9/16 = .5625	

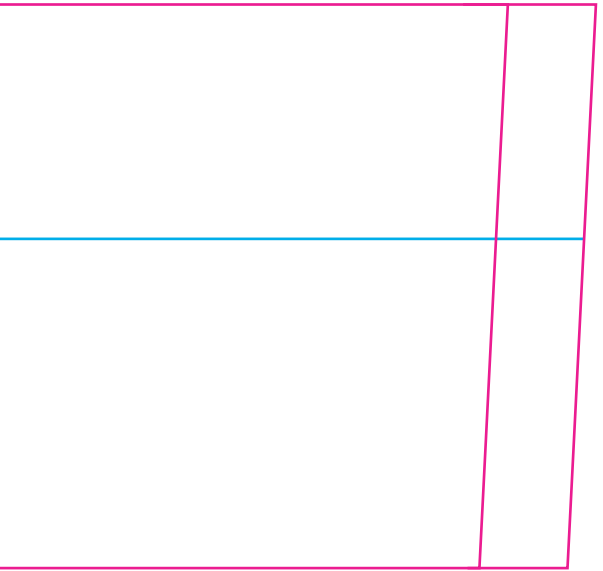

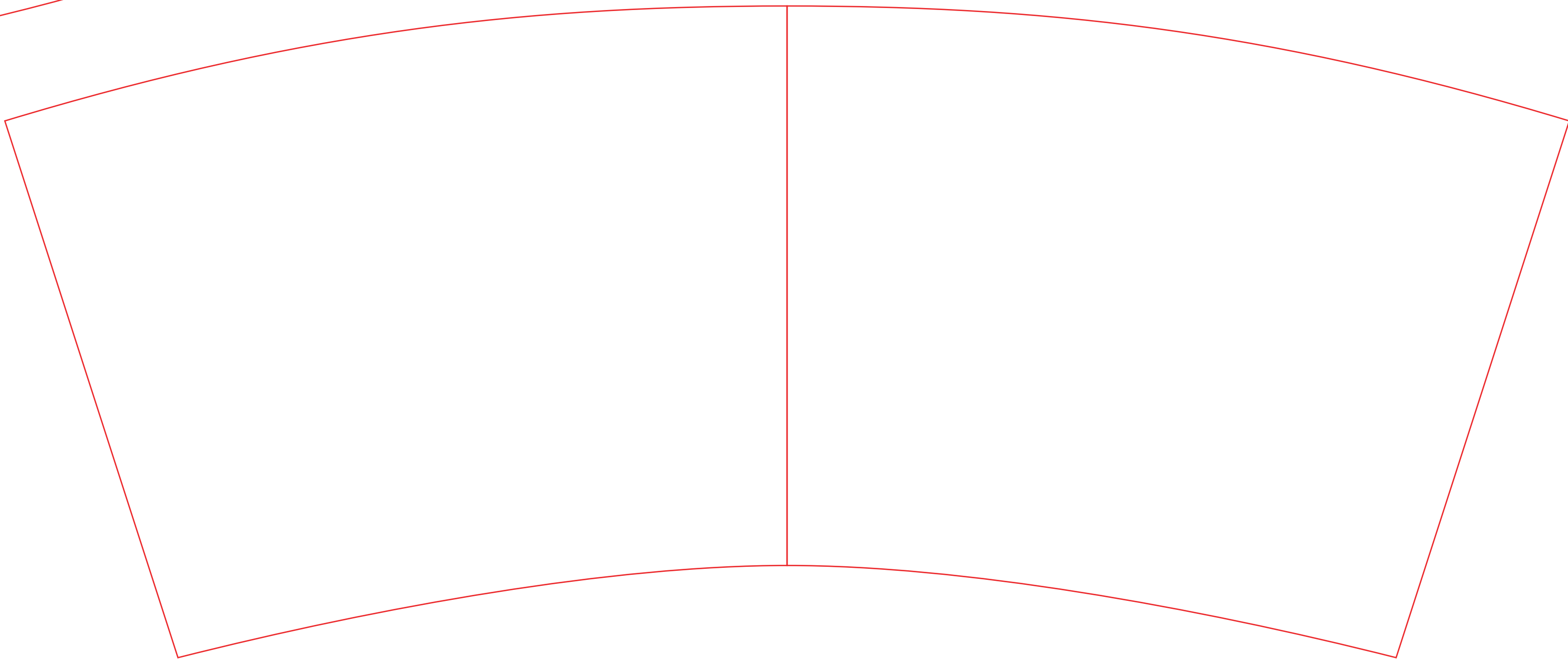
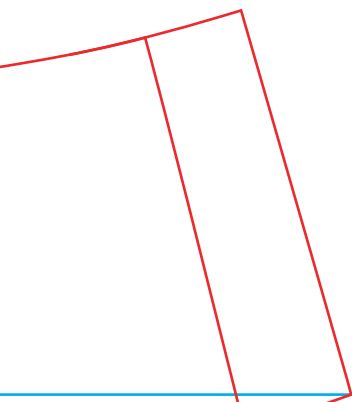

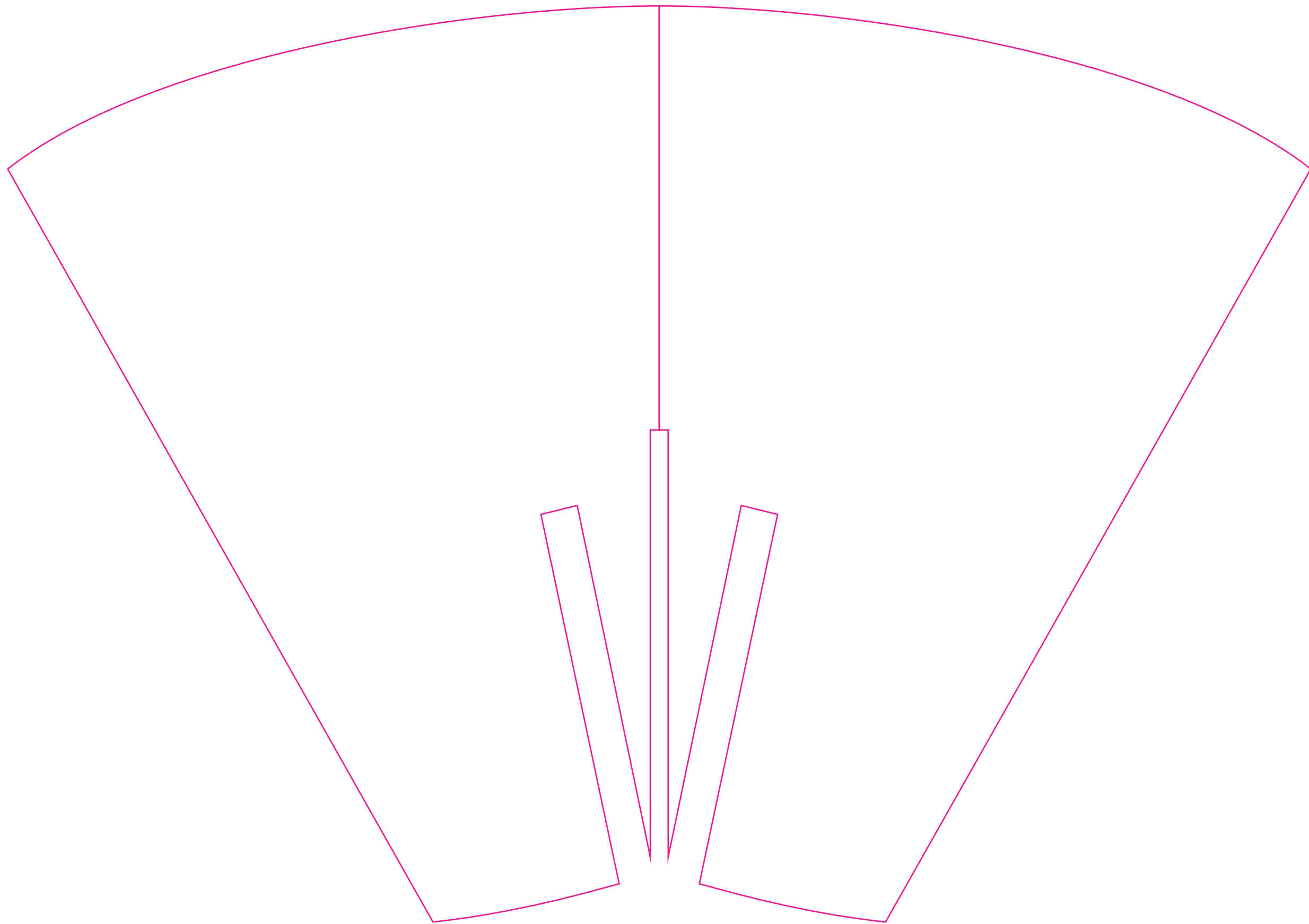

Canopy for Razorback version

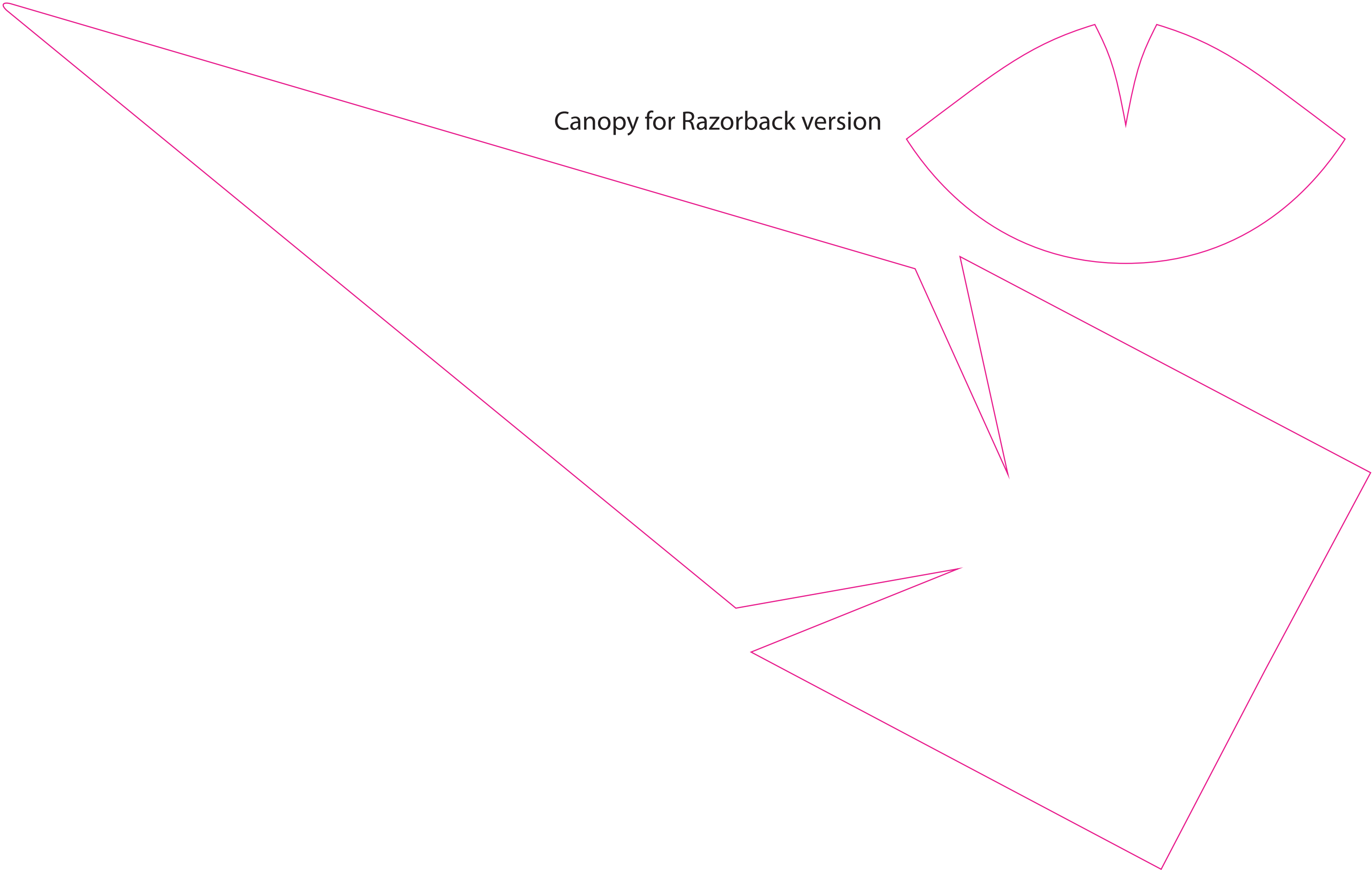

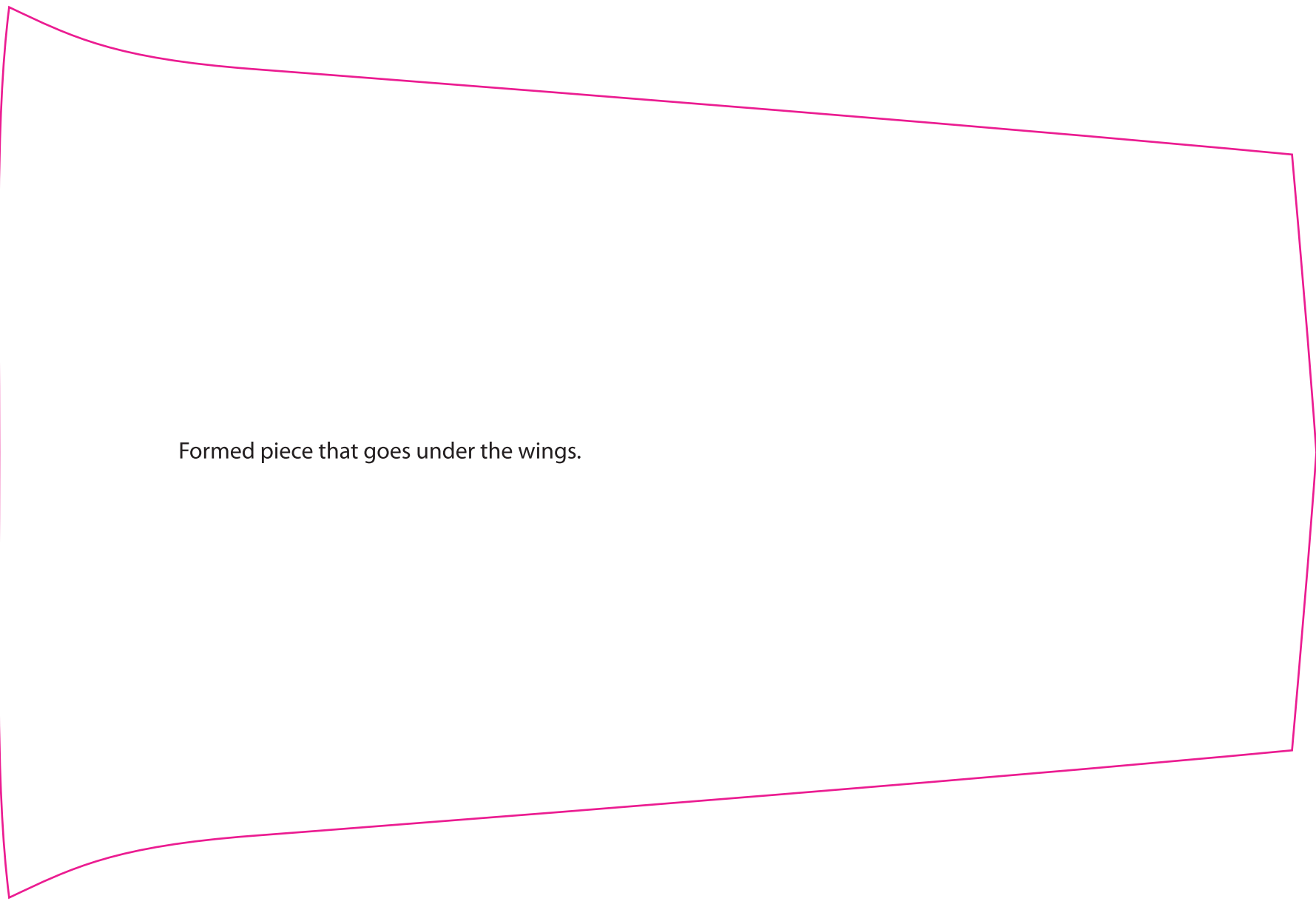

Formed piece that goes under the wings.

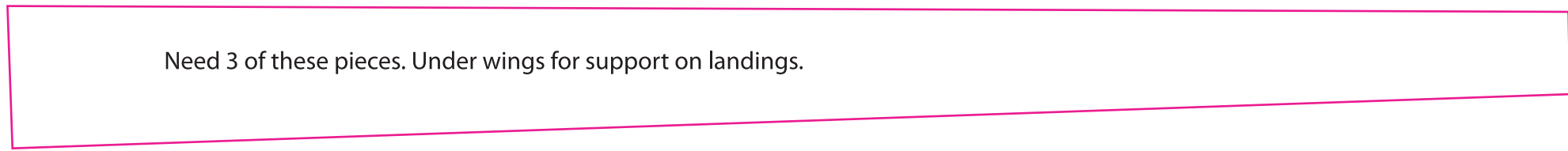

Need 3 of these pieces. Under wings for support on landings.

