



23 1/2"

Peel paper in this area

*Don't peel paper in this area*

*Don't peel paper in this area*

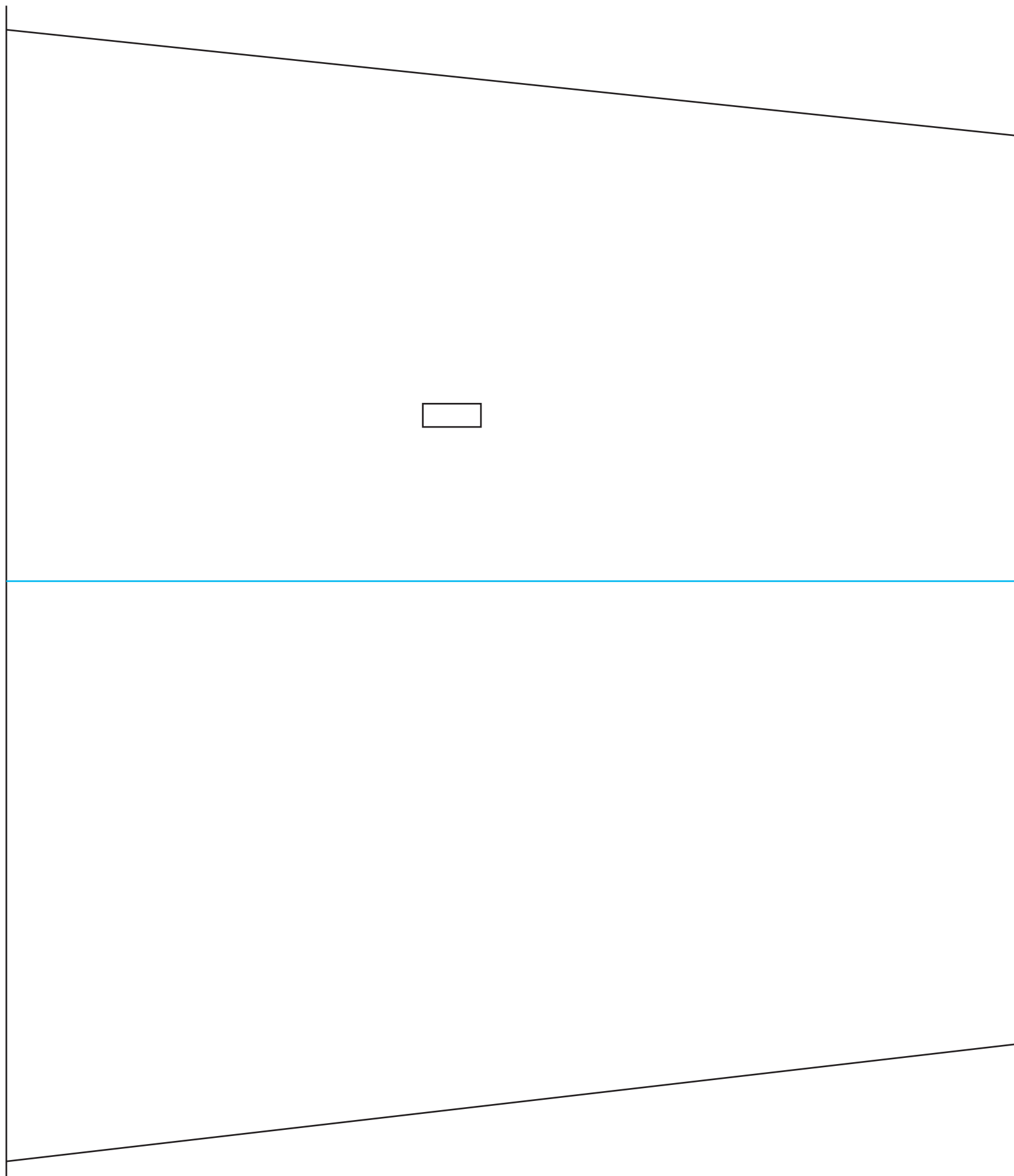
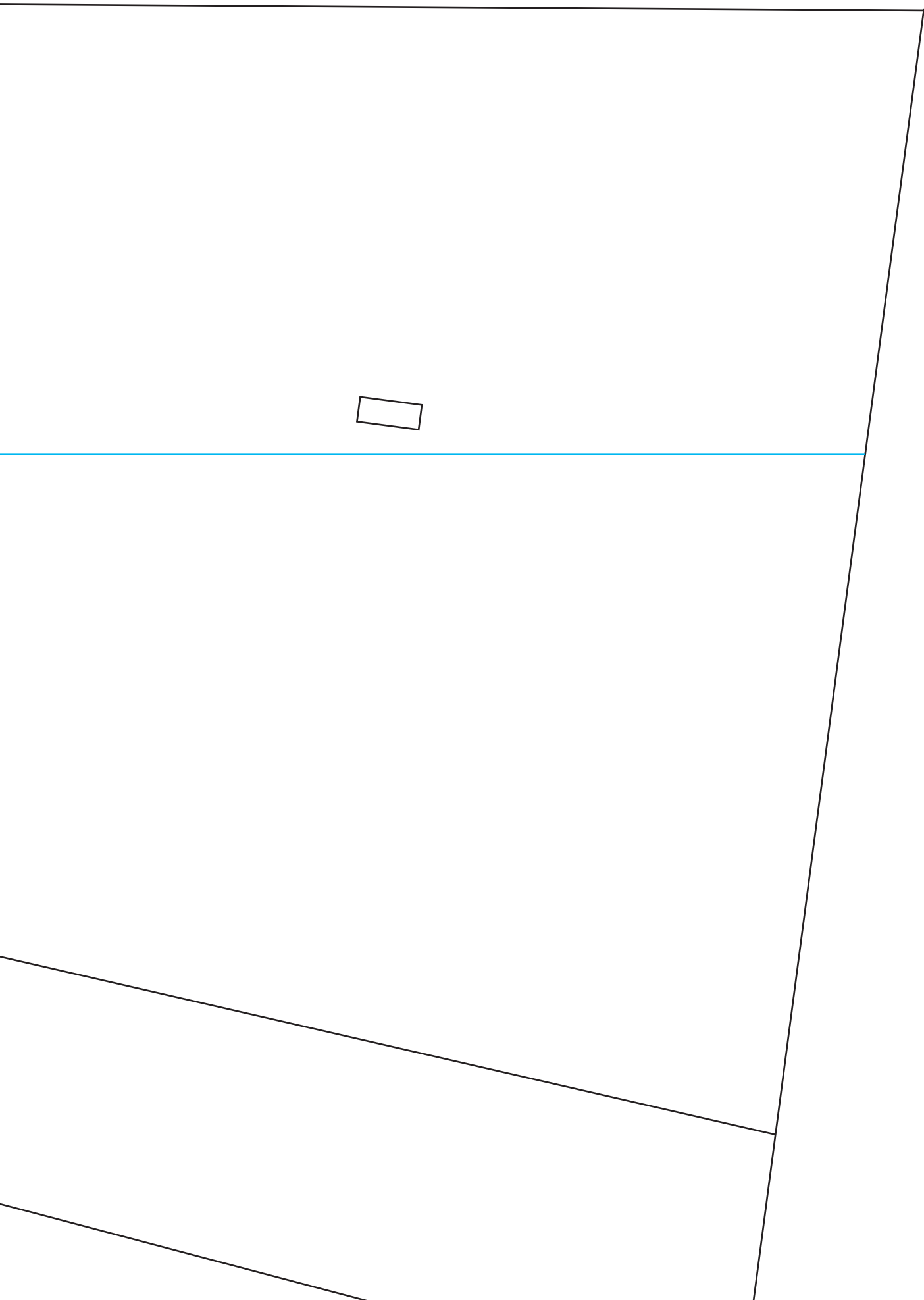

$1/64 = .0156$	$3/16 = .1875$	$5/8 = .625$
$1/32 = .0312$	$1/4 = .25$	$11/16 = .6875$
$3/64 = .0468$	$5/16 = .3125$	$3/4 = .75$
$1/16 = .0625$	$3/8 = .375$	$13/16 = .8125$
$3/32 = .0937$	$7/16 = .4375$	$7/8 = .875$
$1/8 = .125$	$1/2 = .5$	$15/16 = .9375$
$5/32 = .1562$	$9/16 = .5625$	

23 1/2"

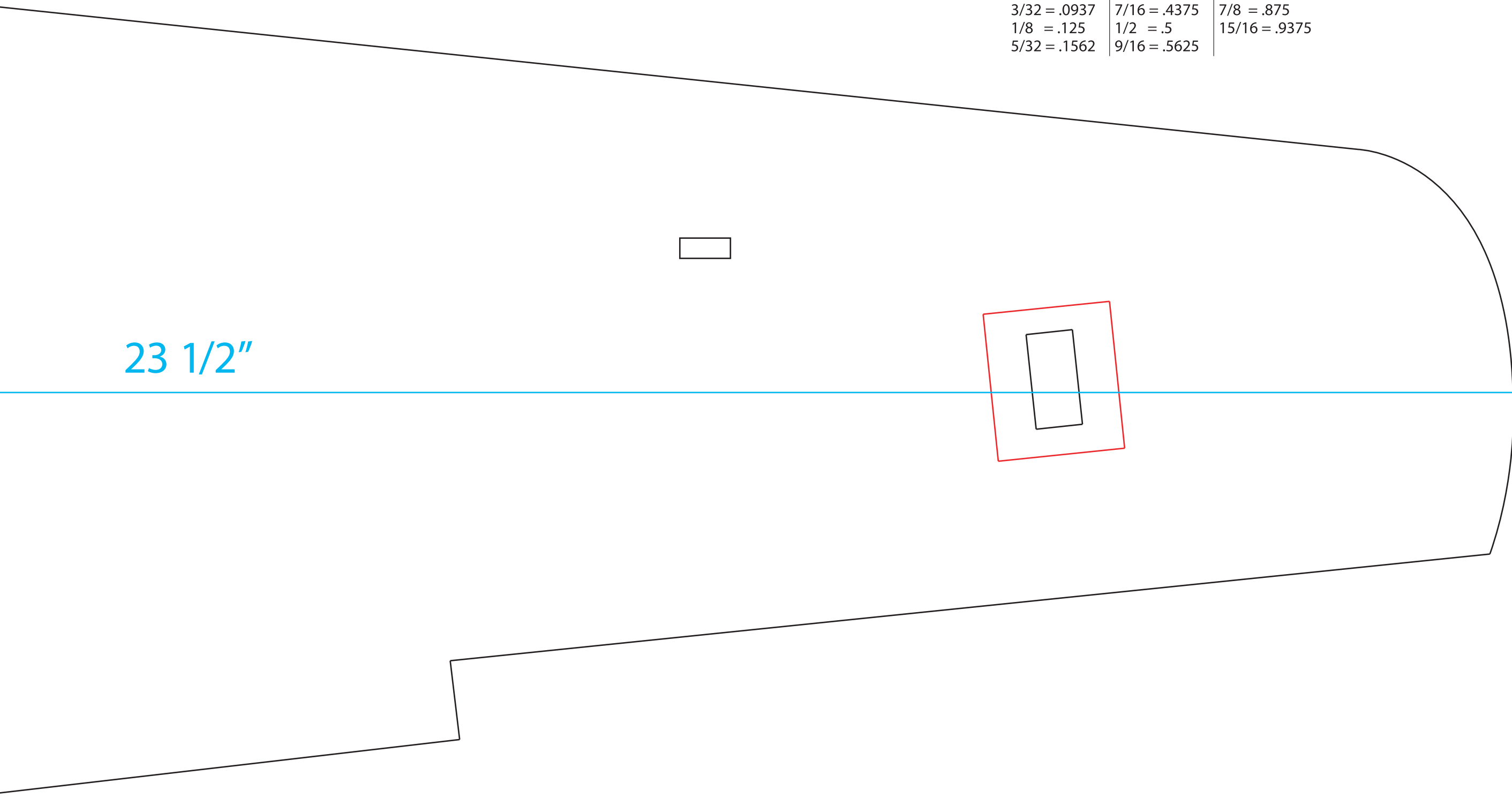

# The Power Pod is the new Flite Test FT Corsiar Power Pack

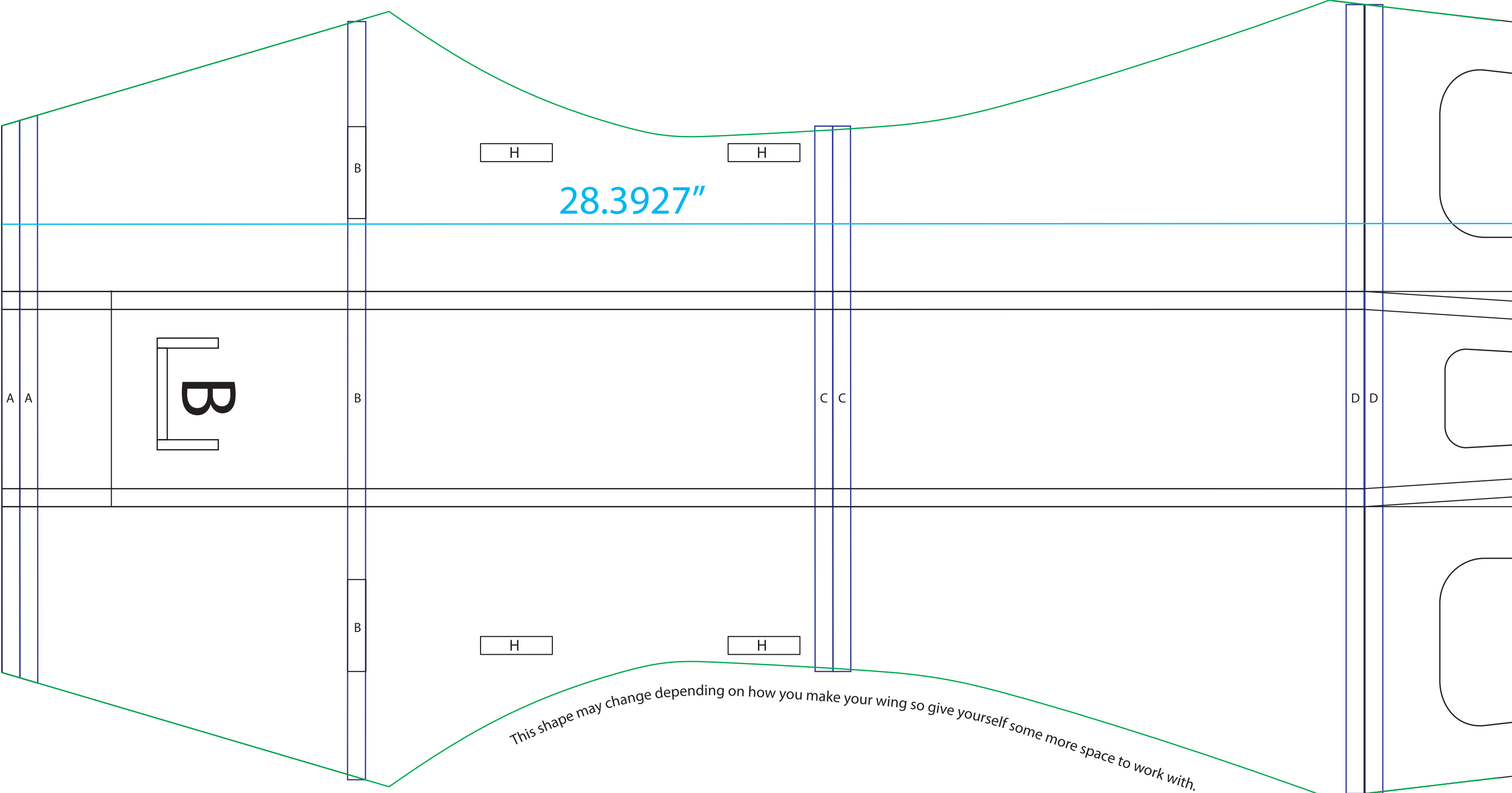

*This shape may change depending on how you make your wing so give yourself some more space to work with.*

This piece goes on the bottom of the fuselage behind the wing and to the rudder.

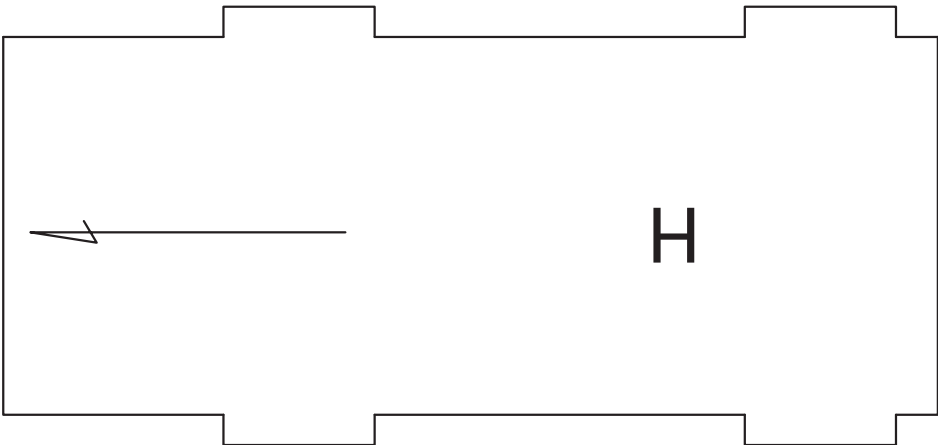
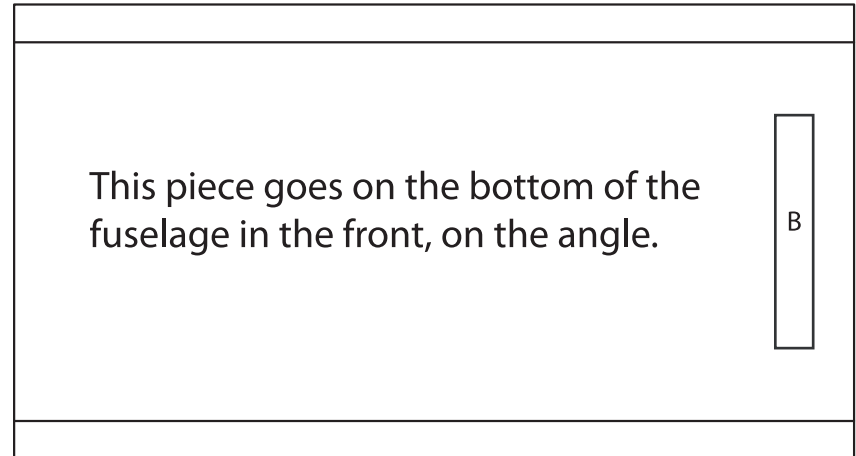
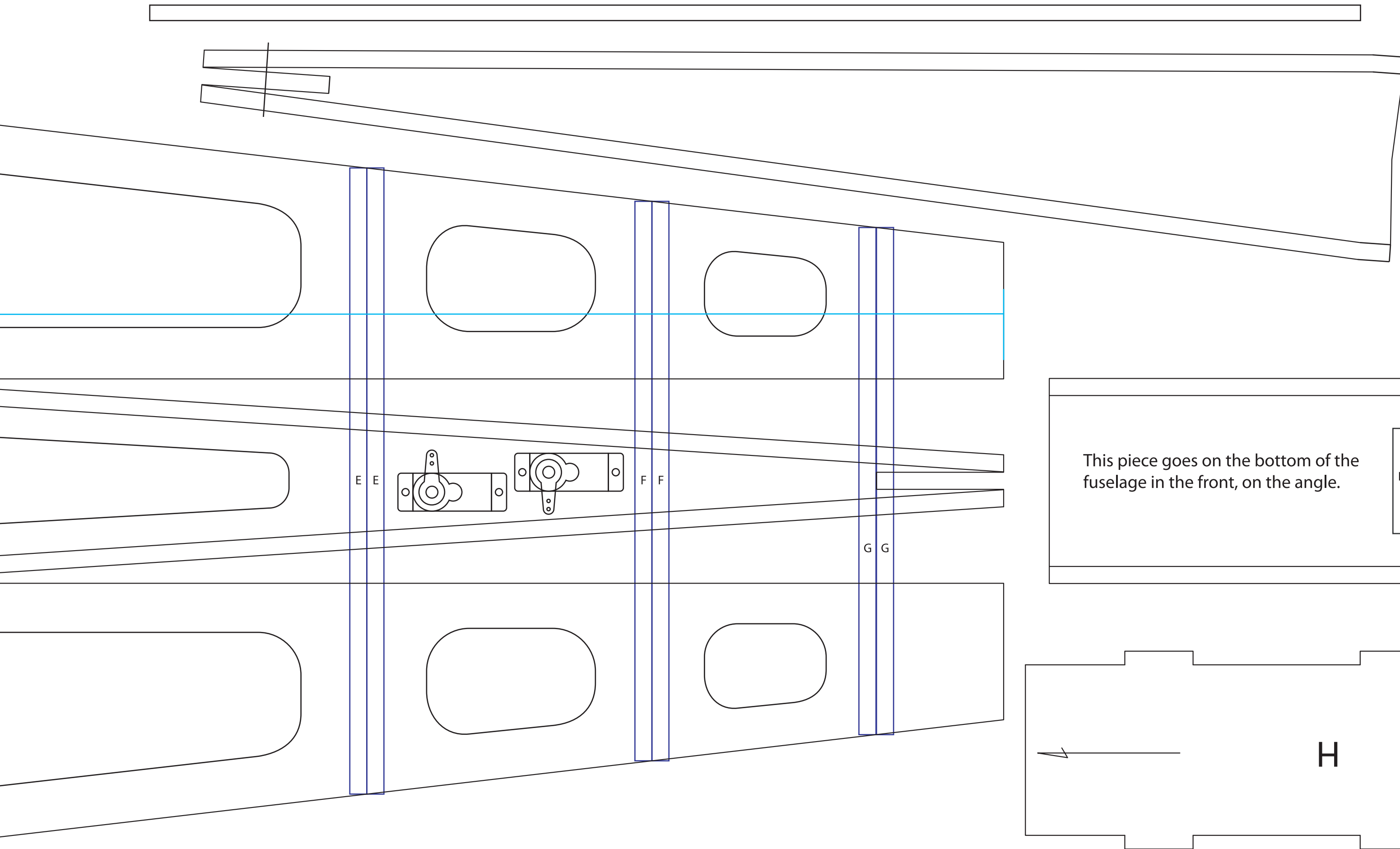

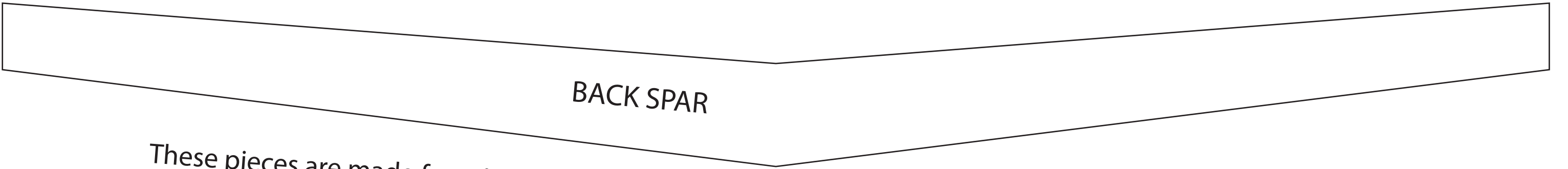

These pieces are made from hobby plywood.

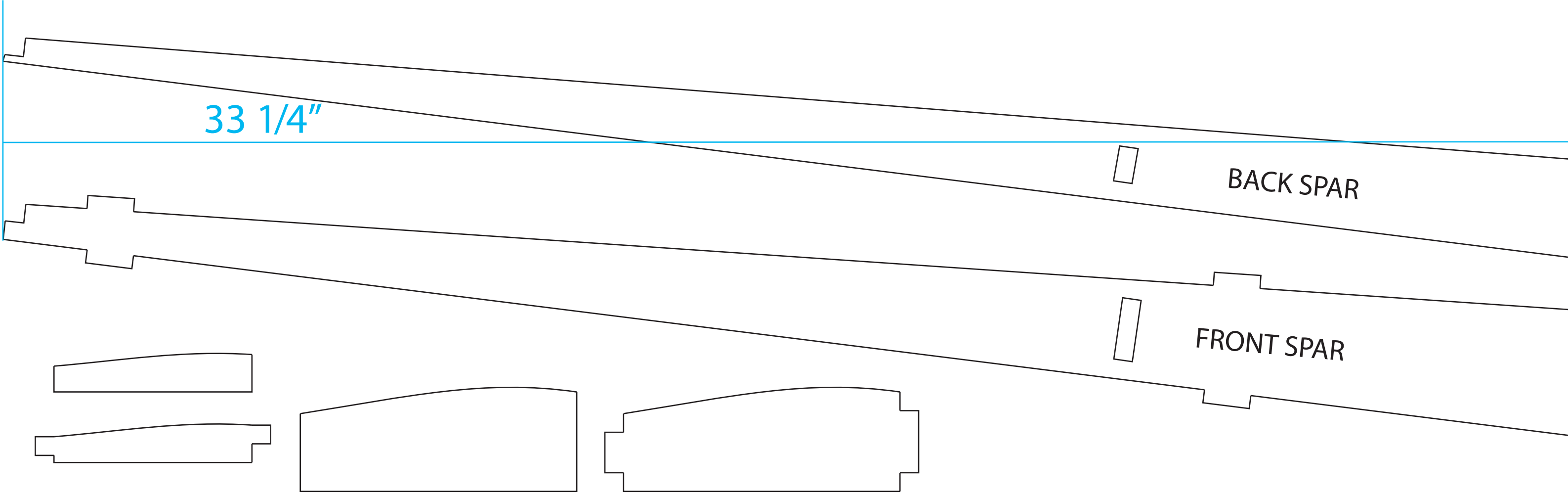
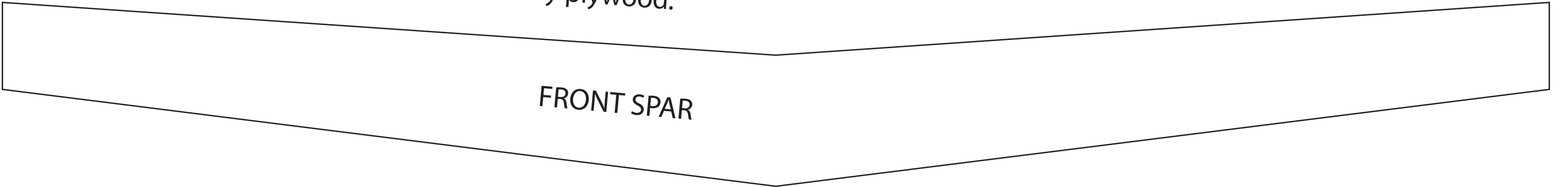

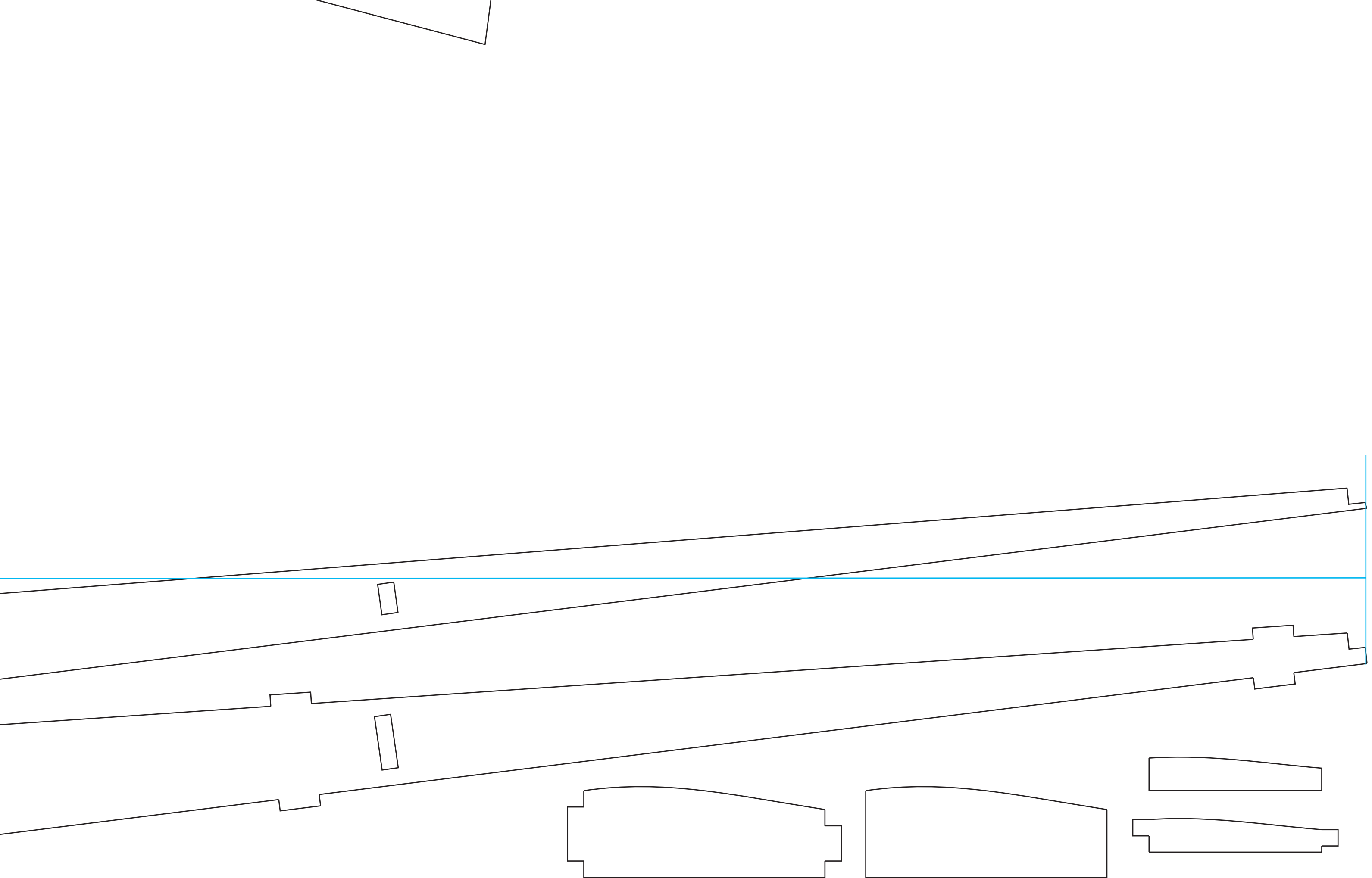

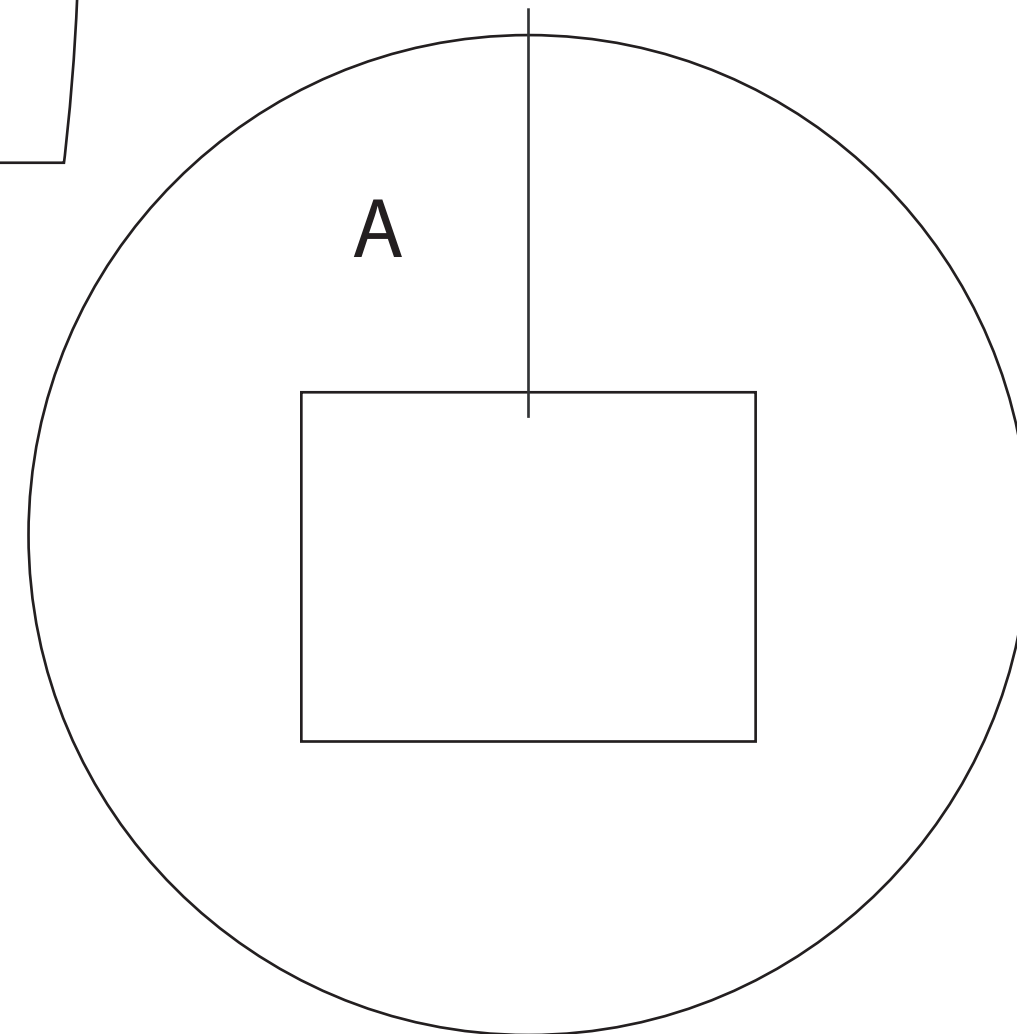
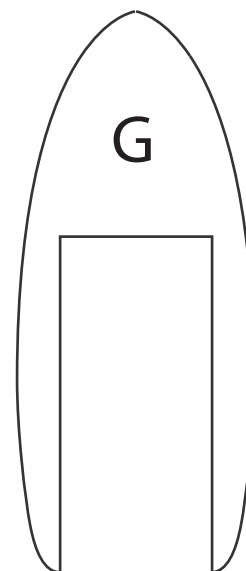
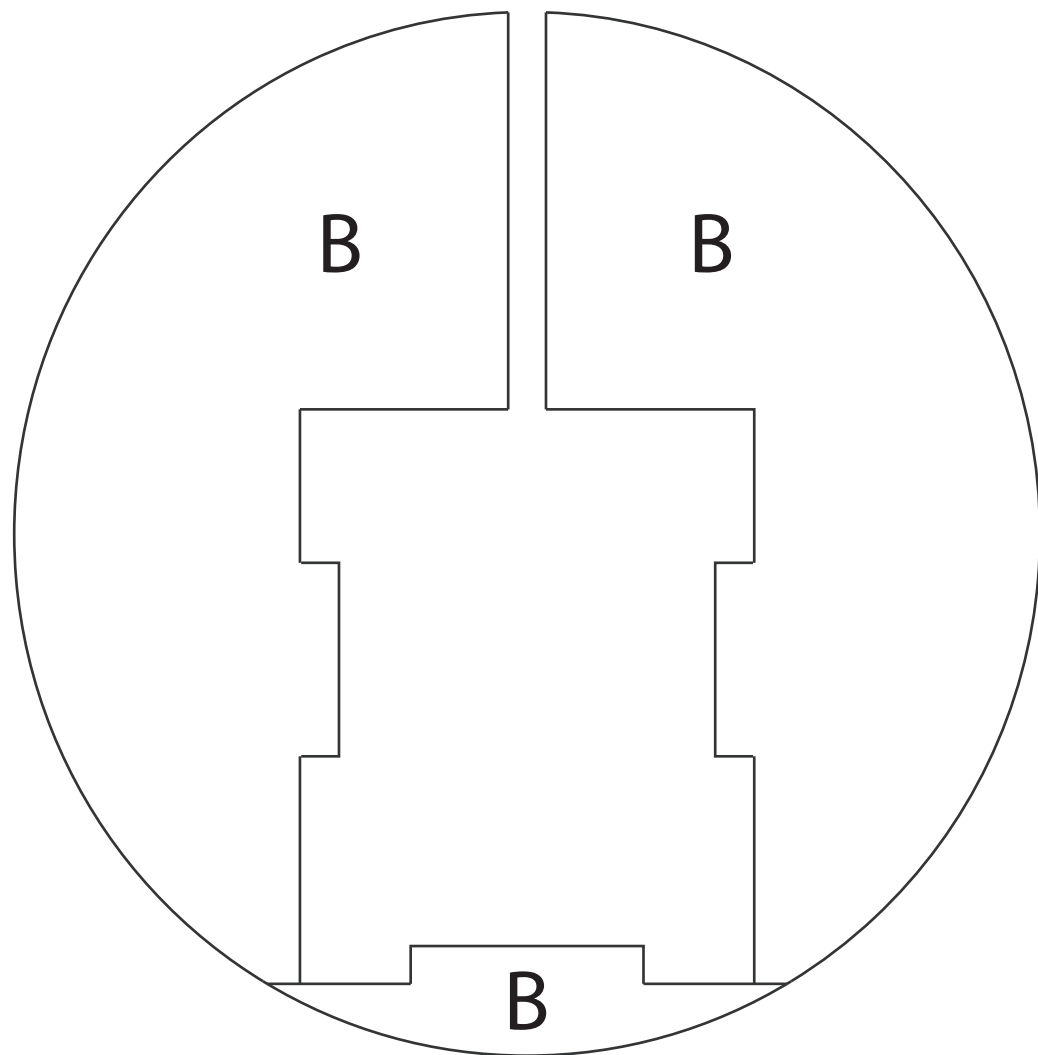
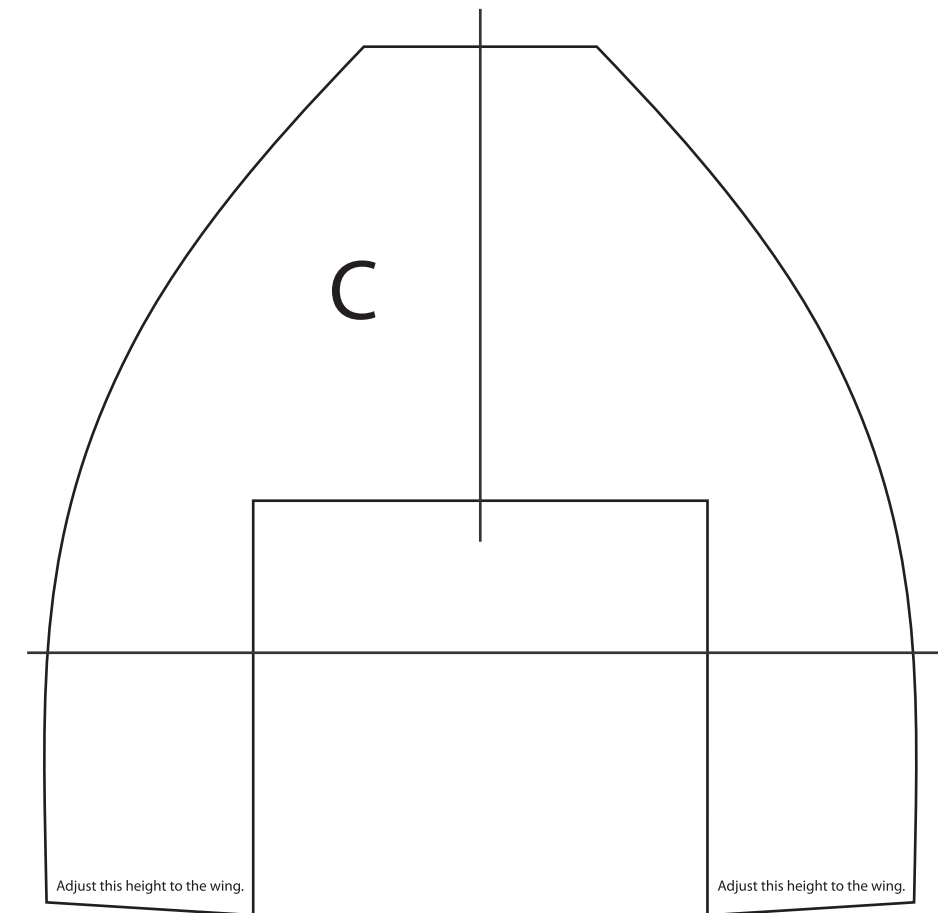
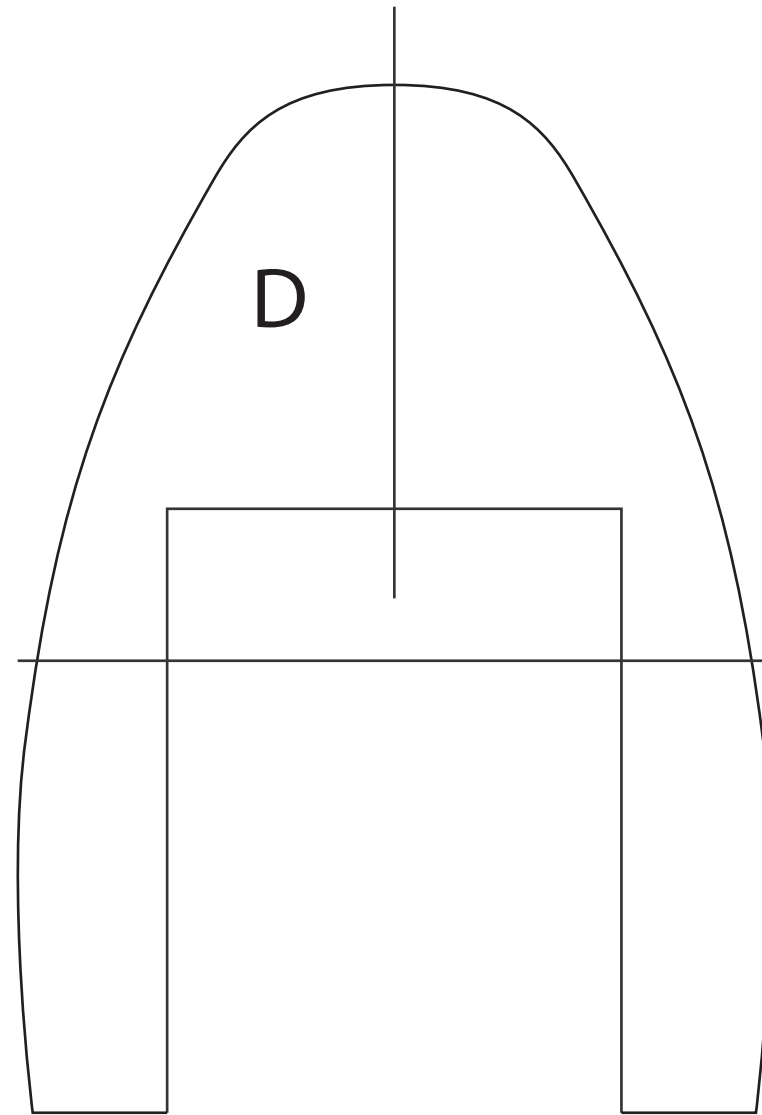
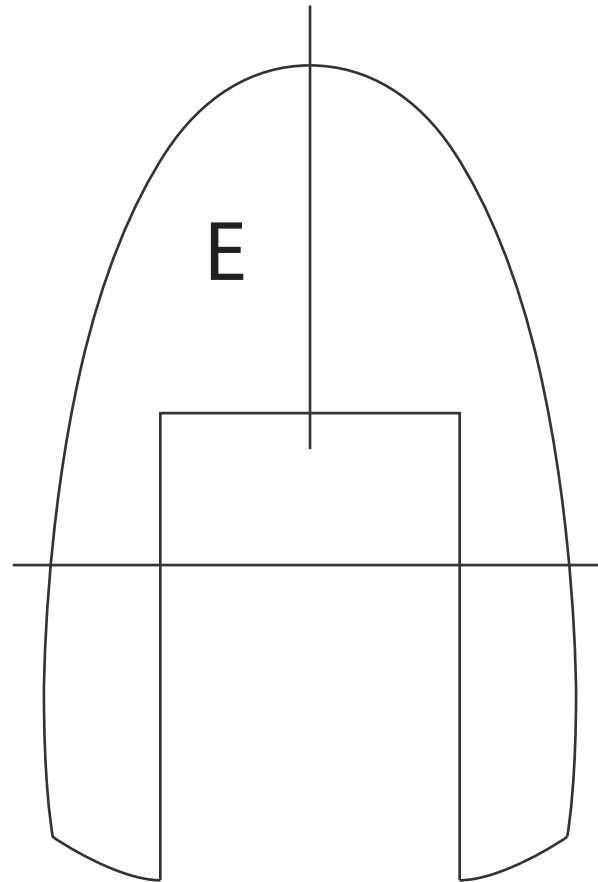
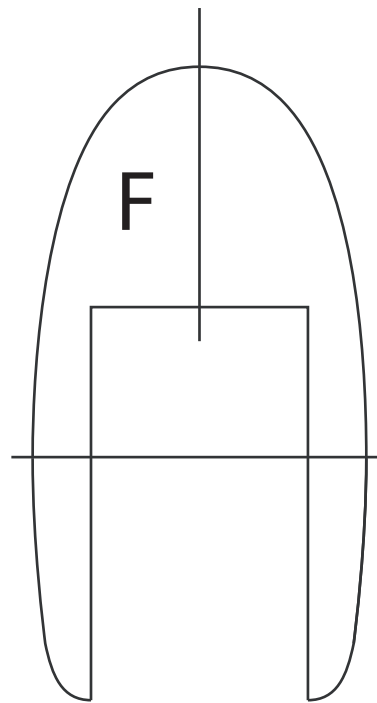



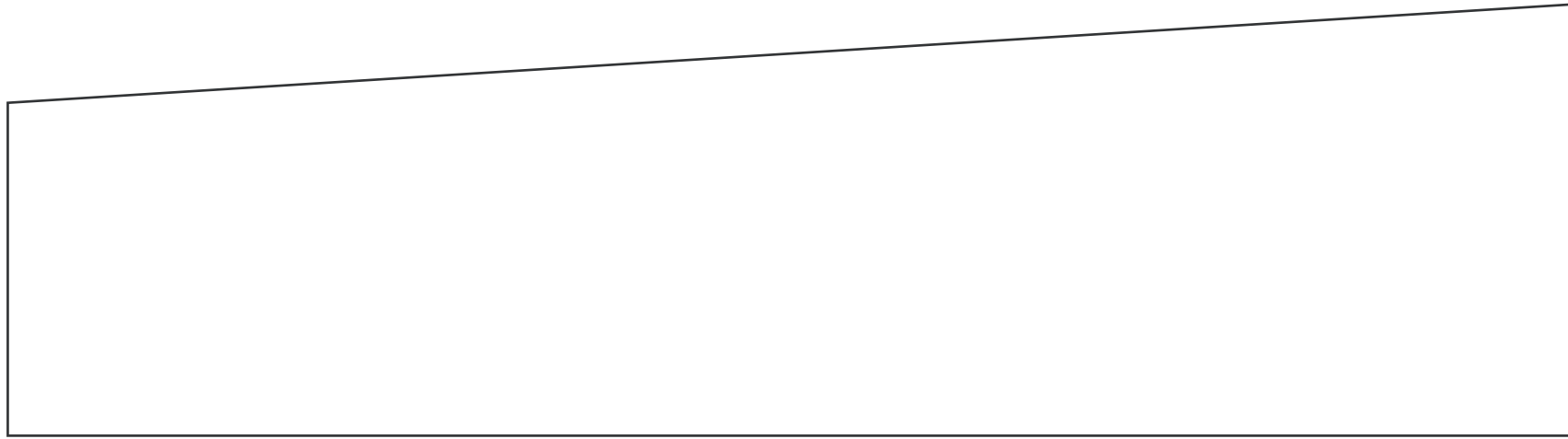

This piece is for the hatch.

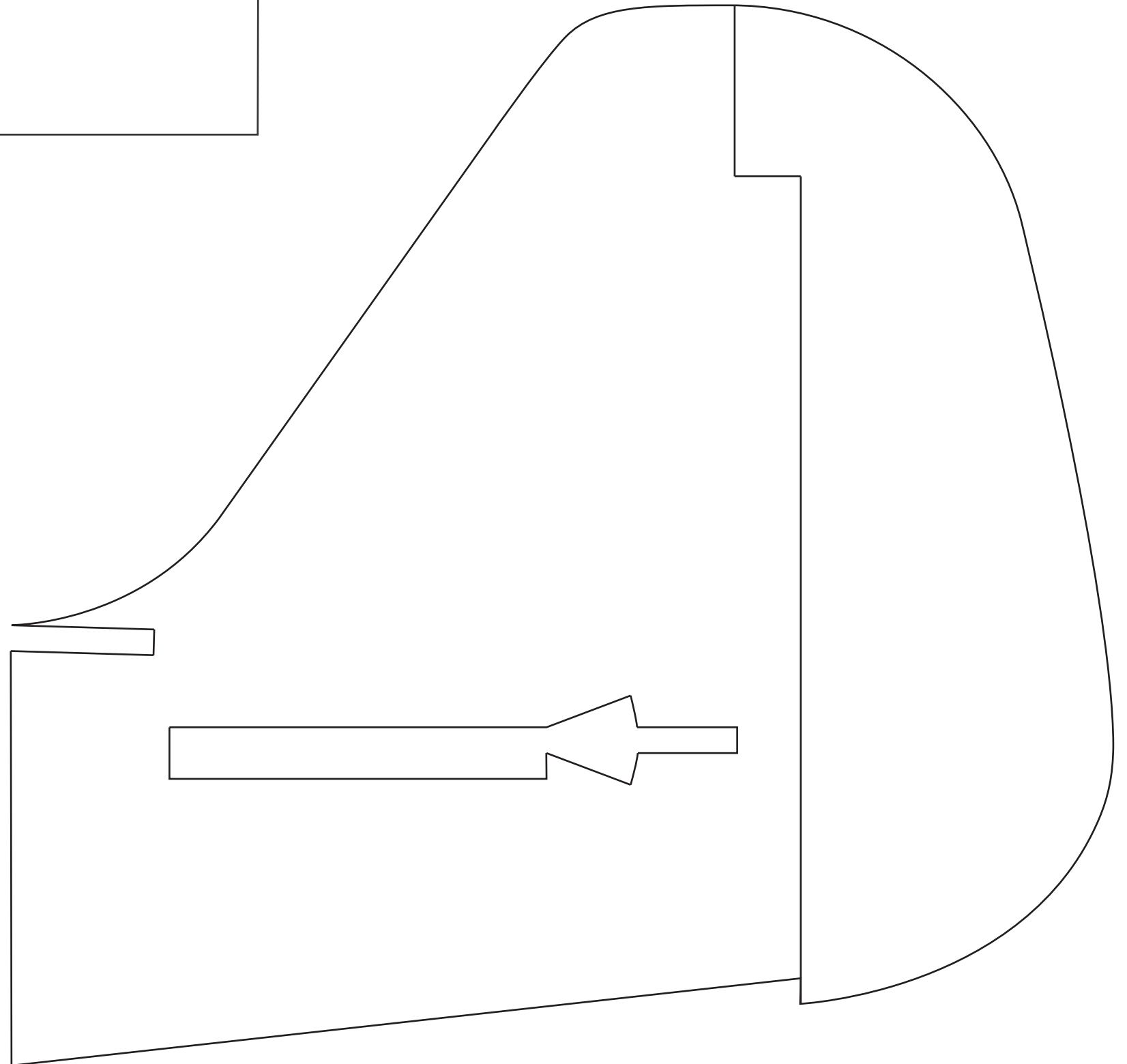
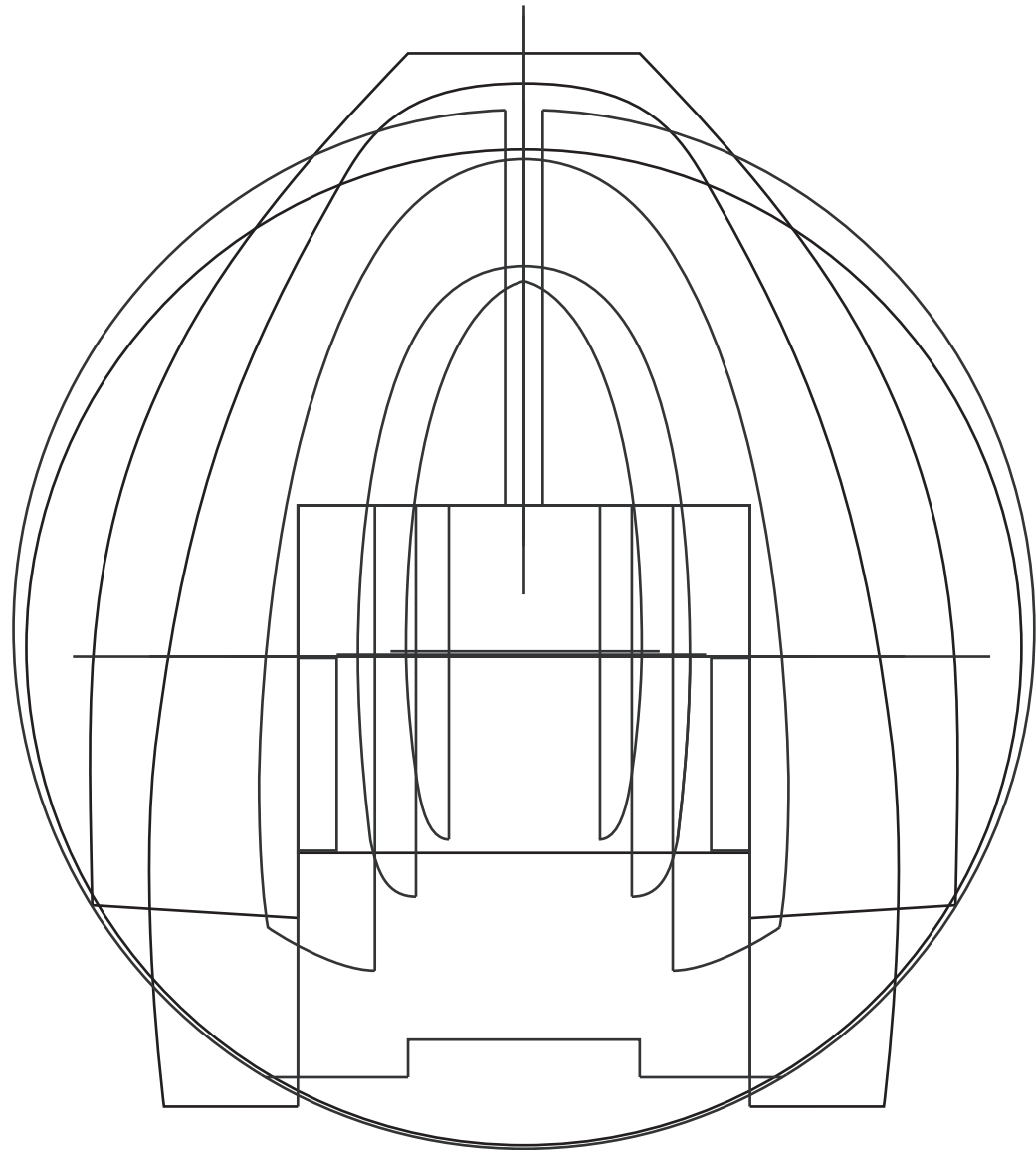

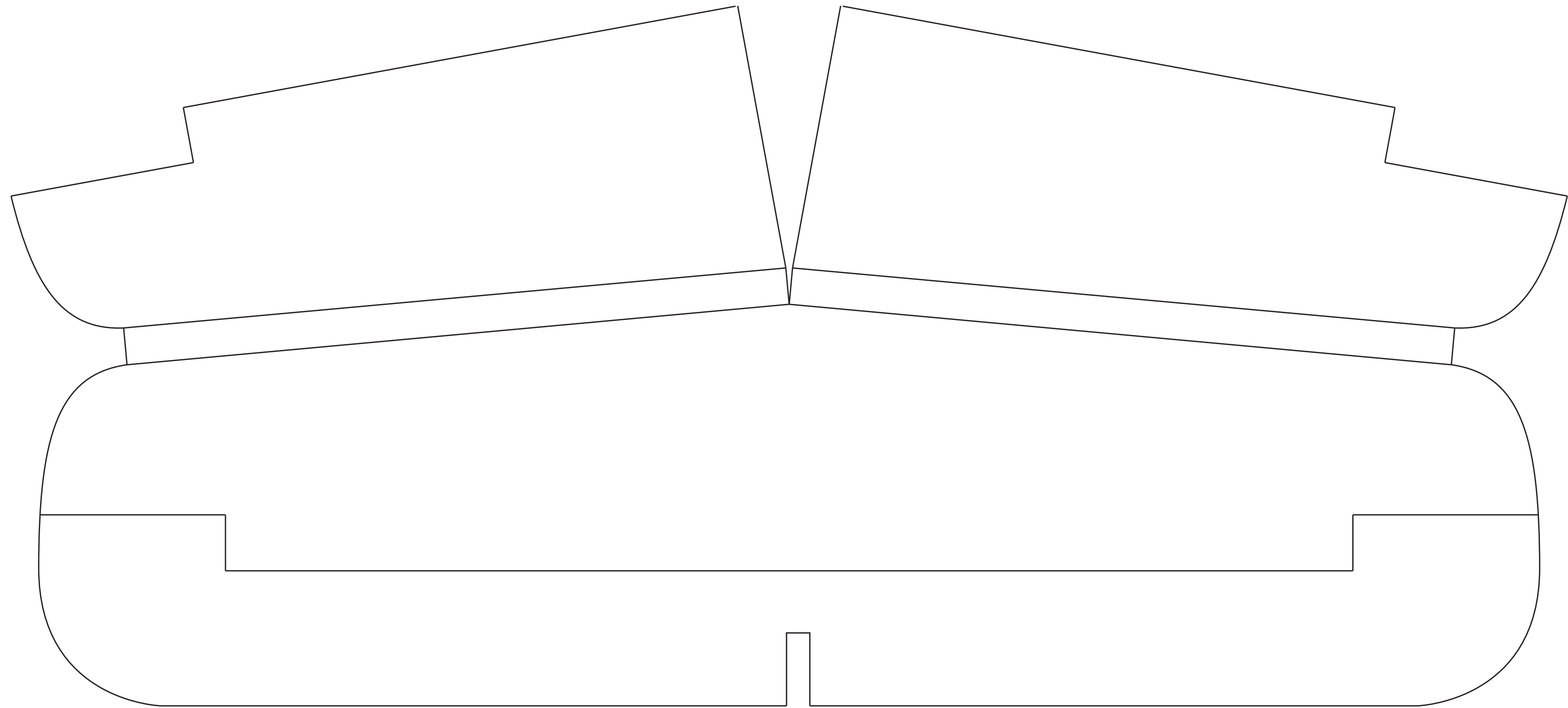

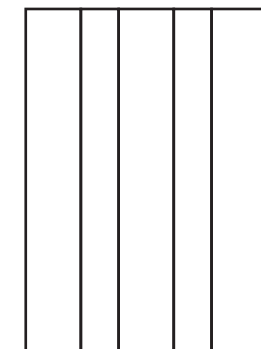
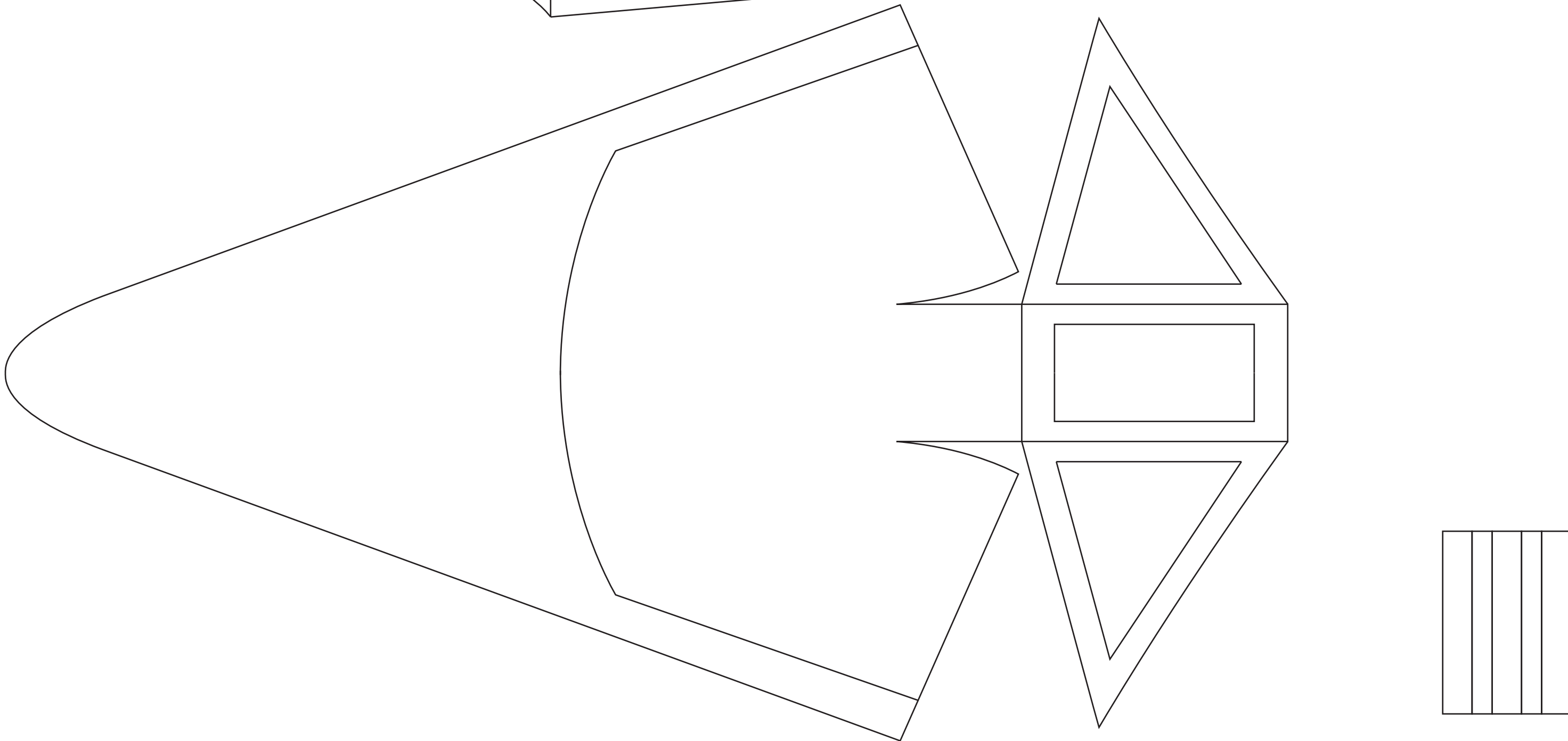

You might want to cut the length of the fuselage covering pieces a little "longer" for any adjustments that might be needed.

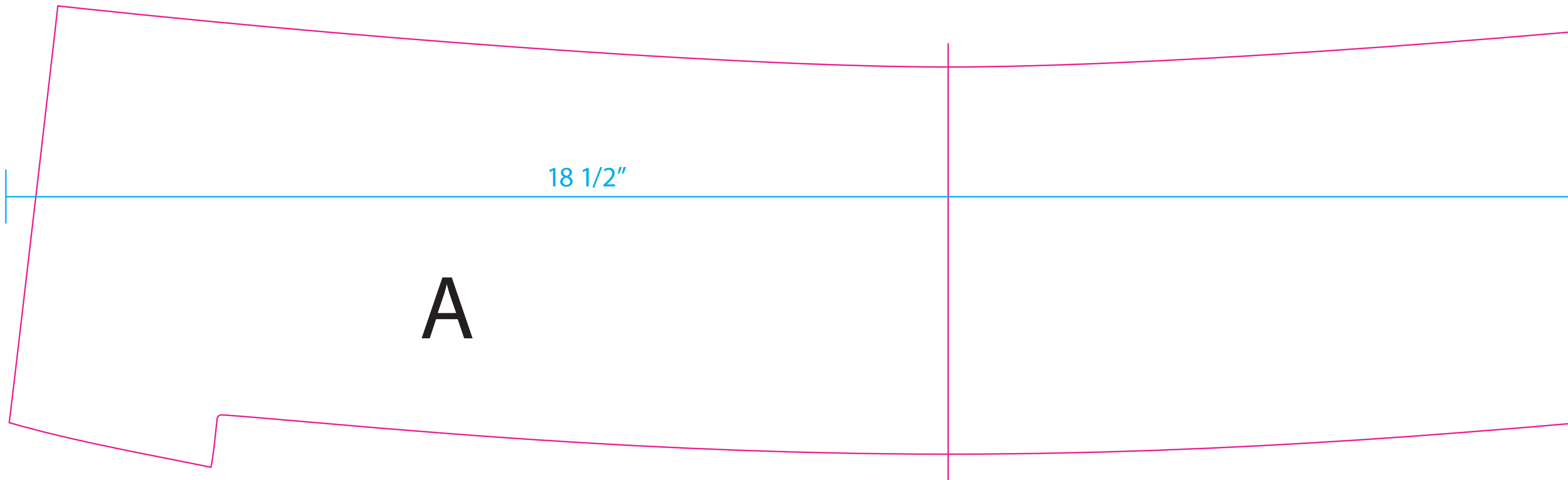
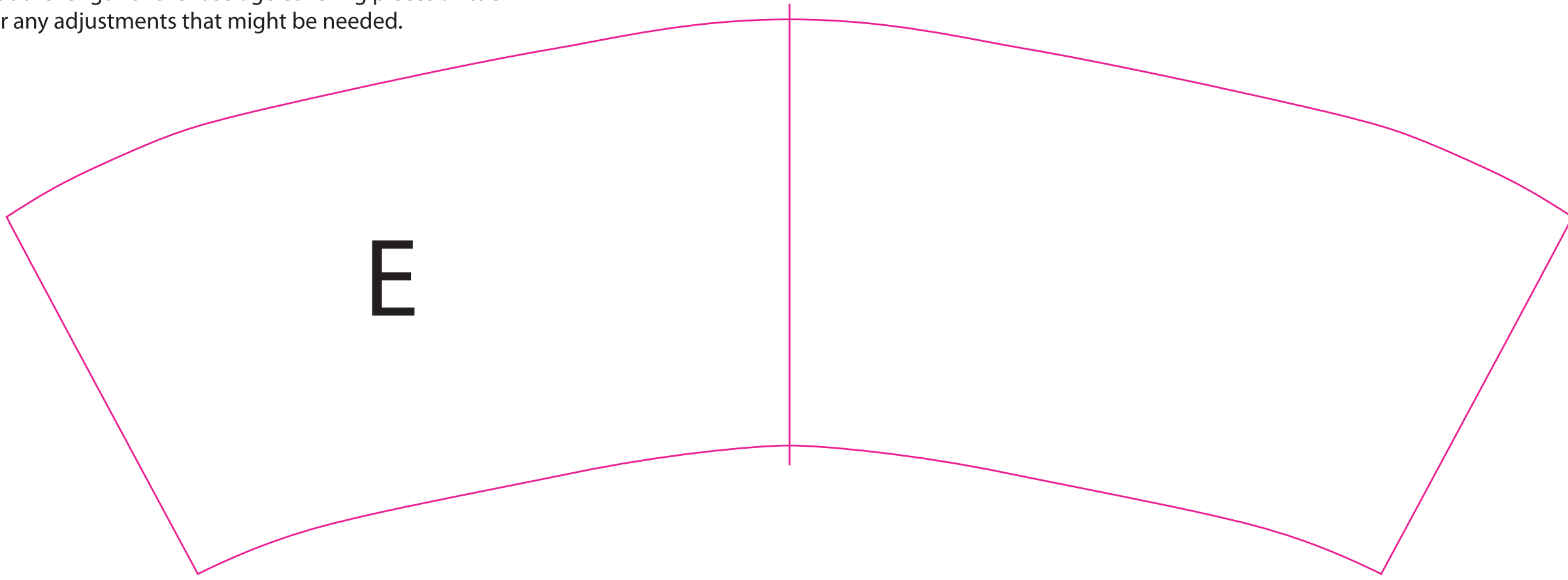

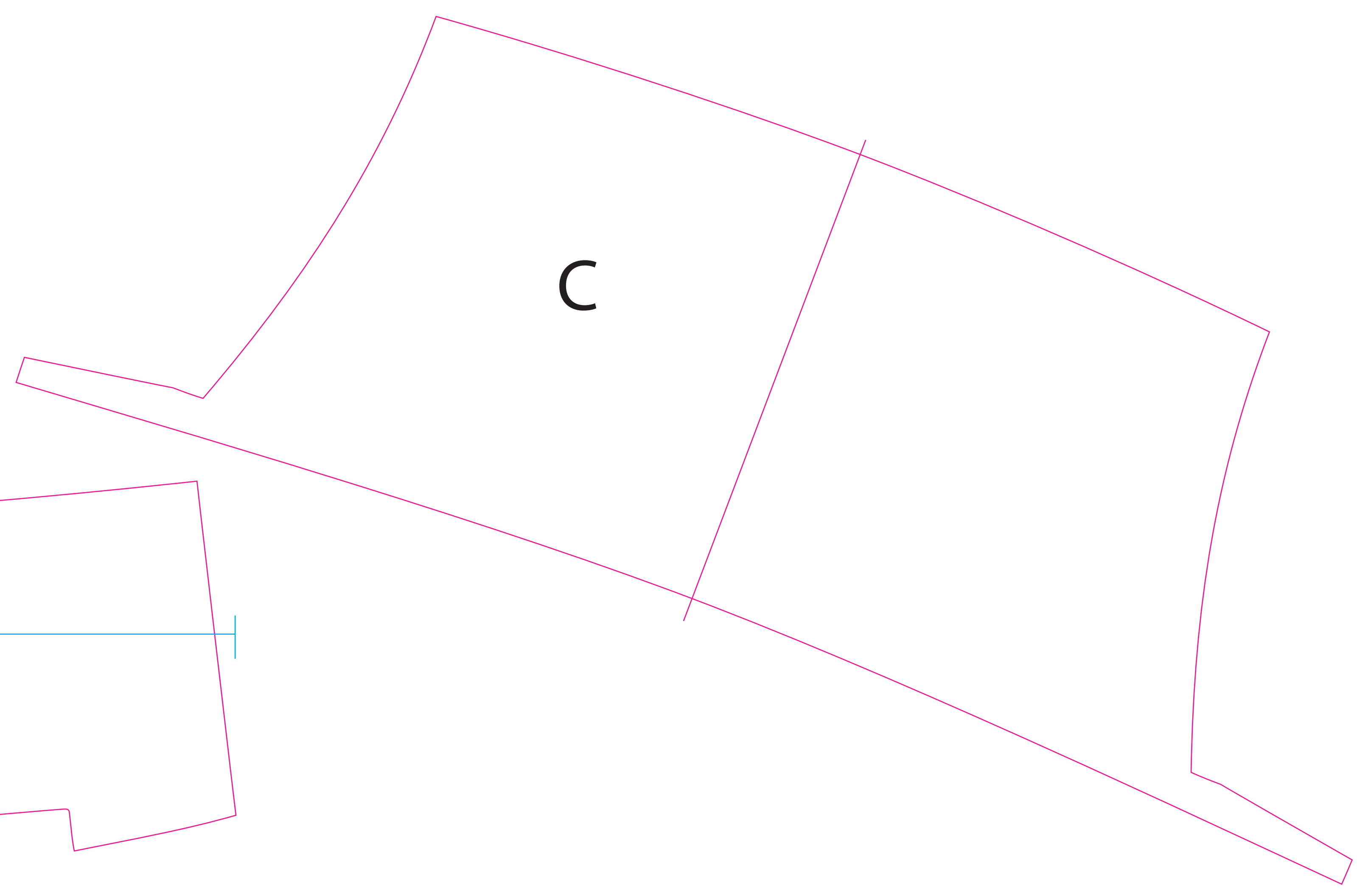

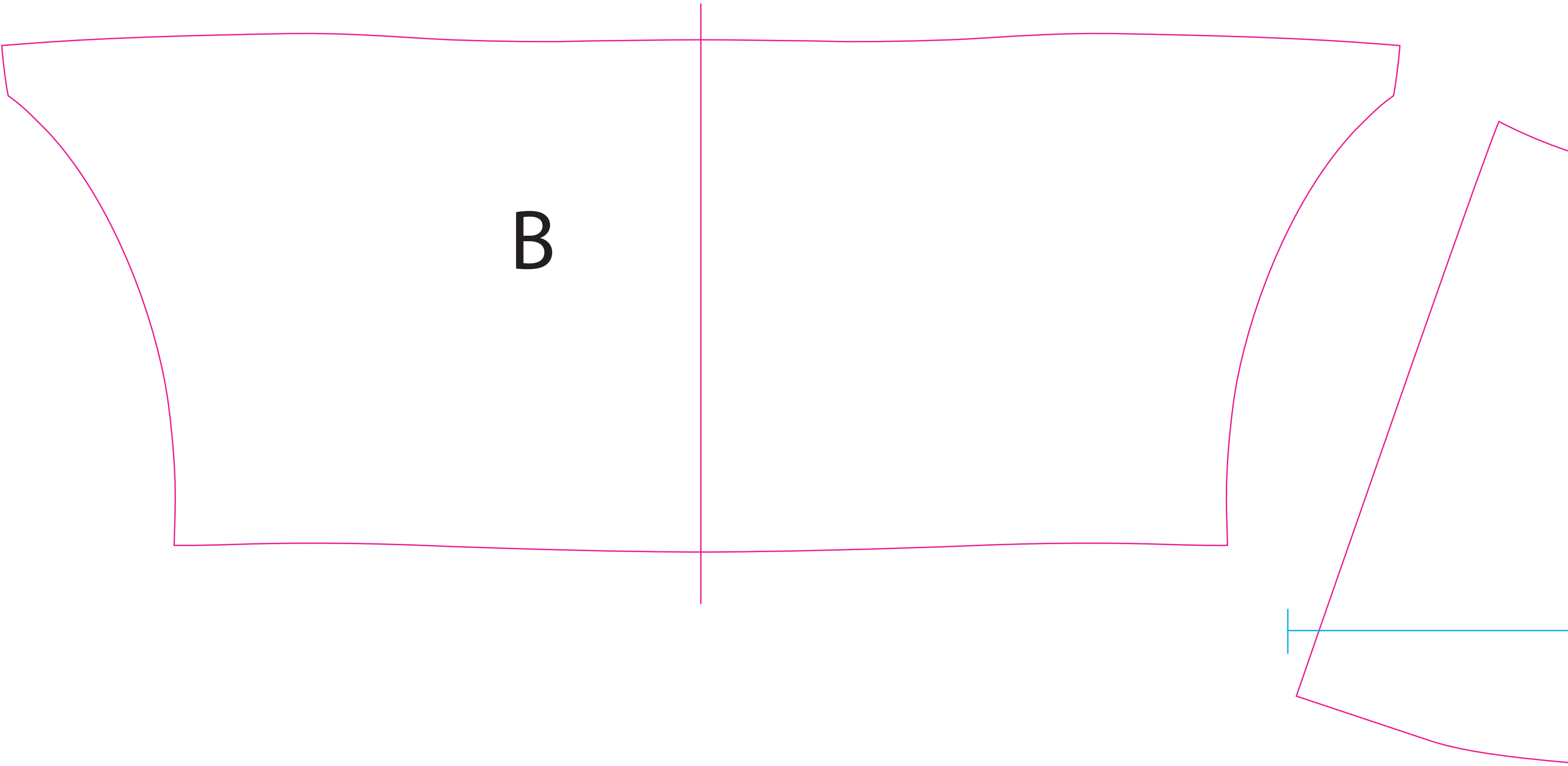

D

17 1/4"

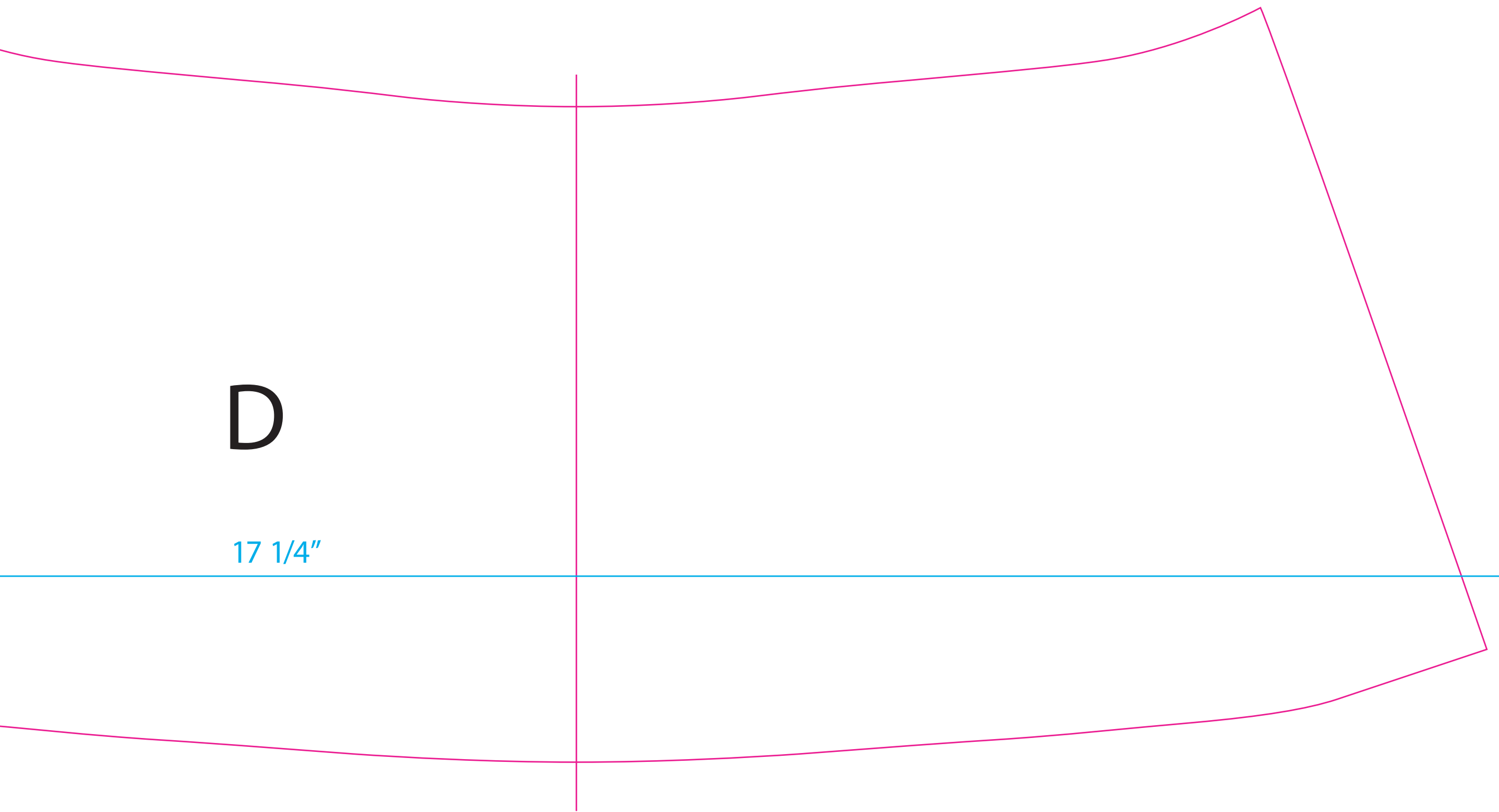

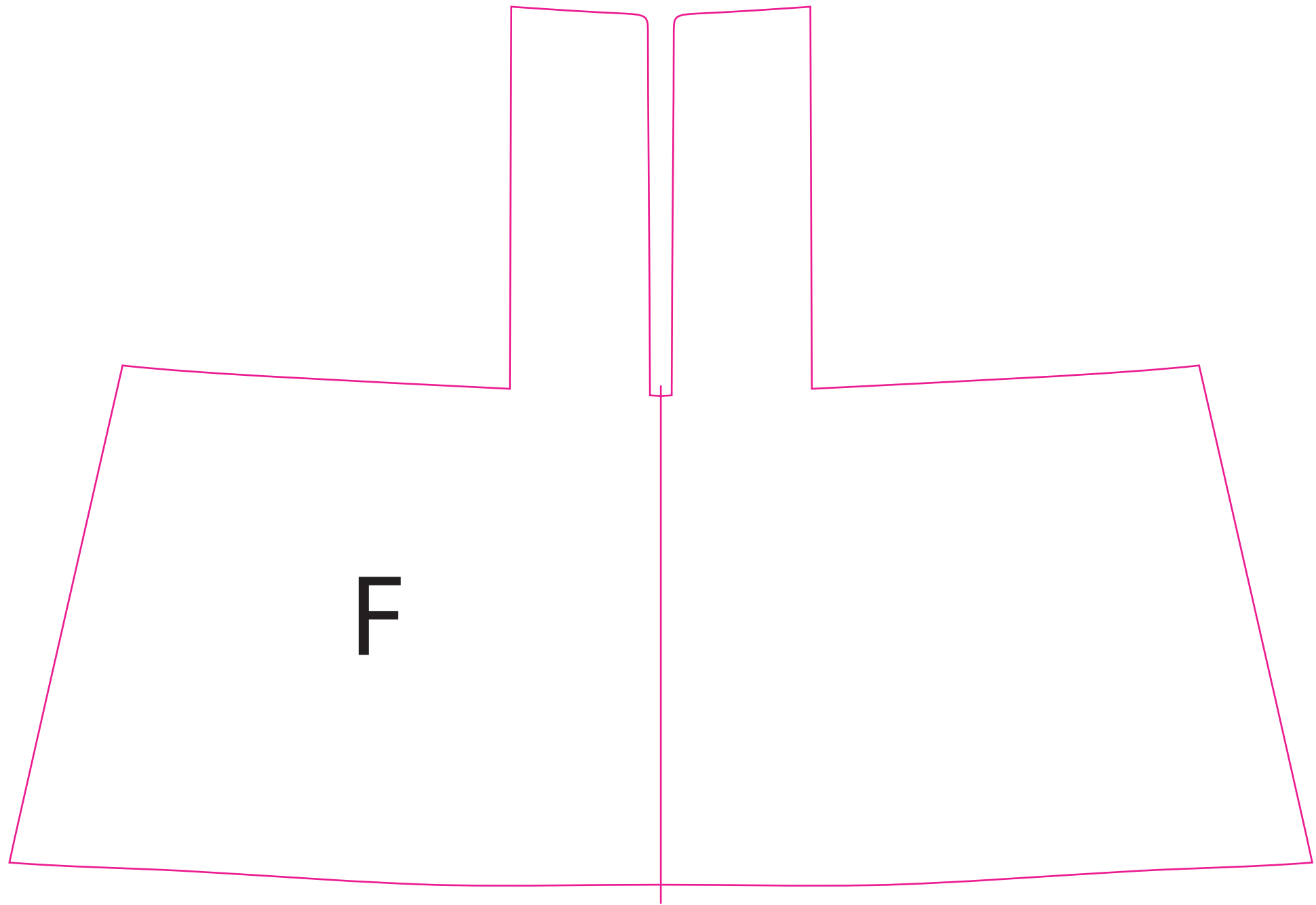

**F**

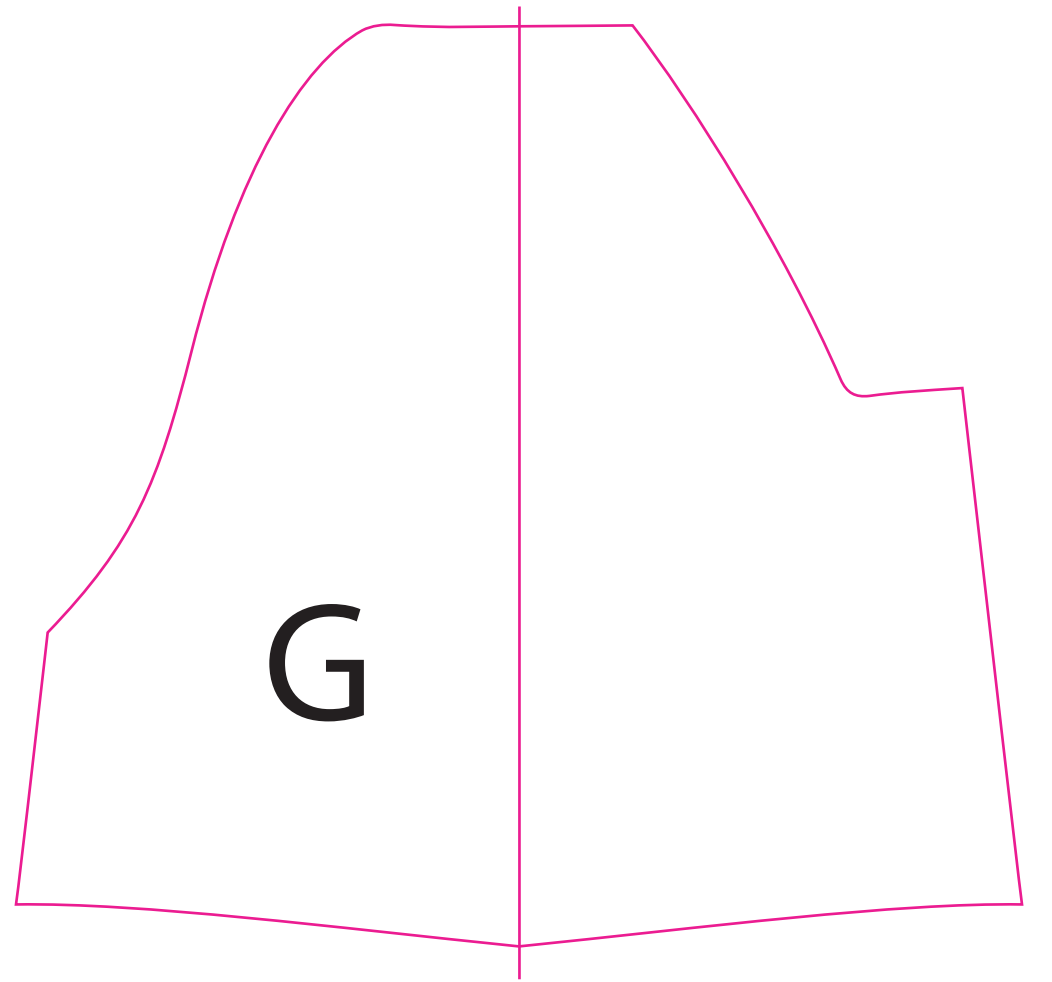

**G**



