

FTF Eagle 56

Designed By: Unknown
Drawing By: Dan Sponholz

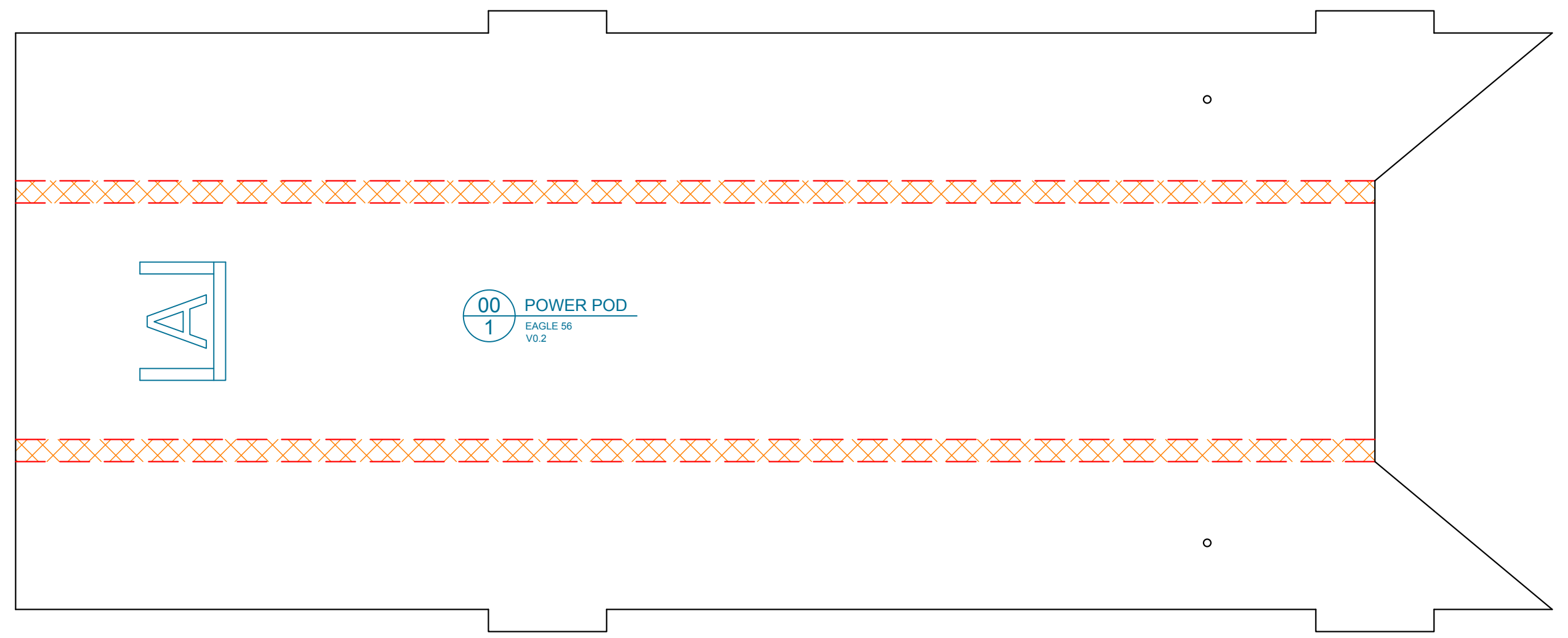
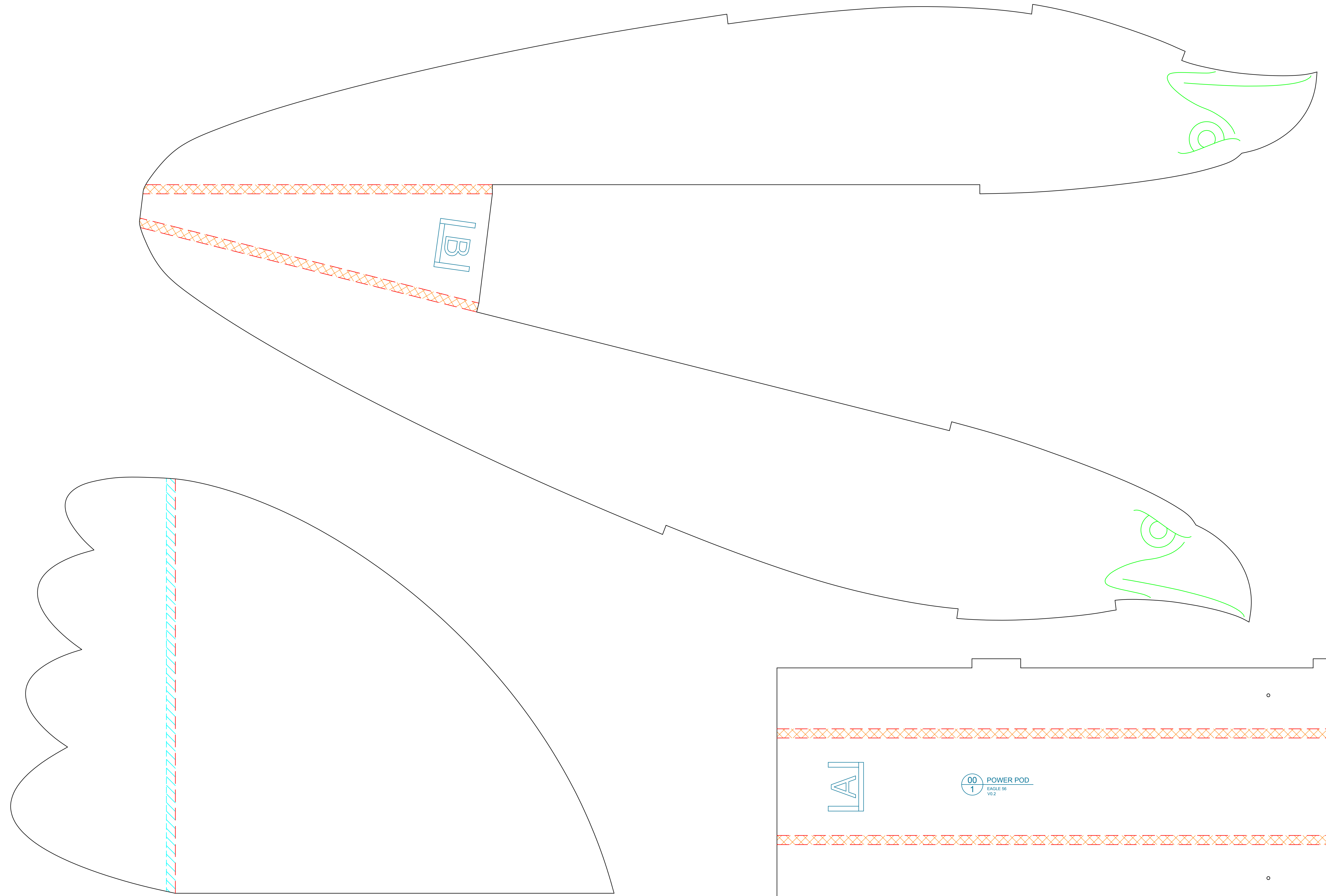

FTF Eagle 56

Designed By: Unknown
Drawing By: Dan Sponholz

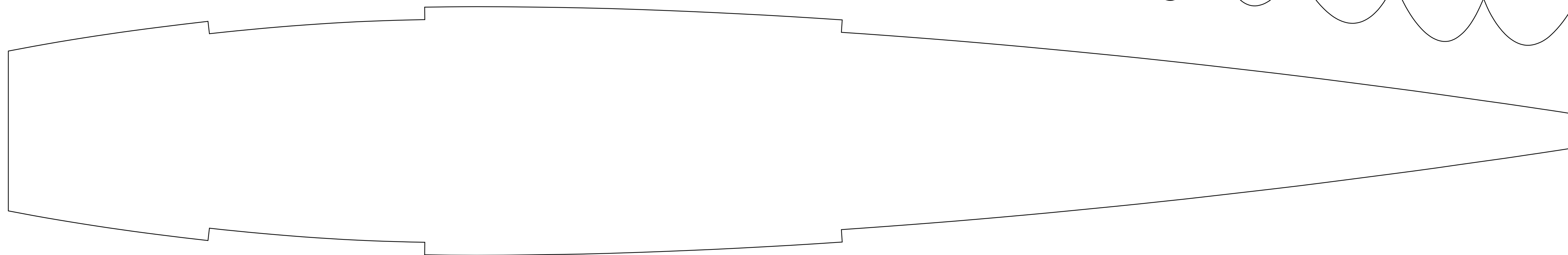
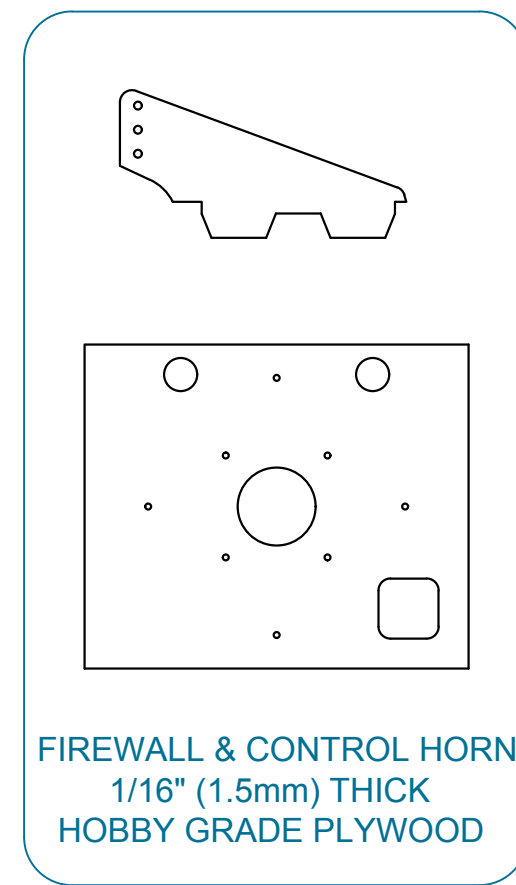
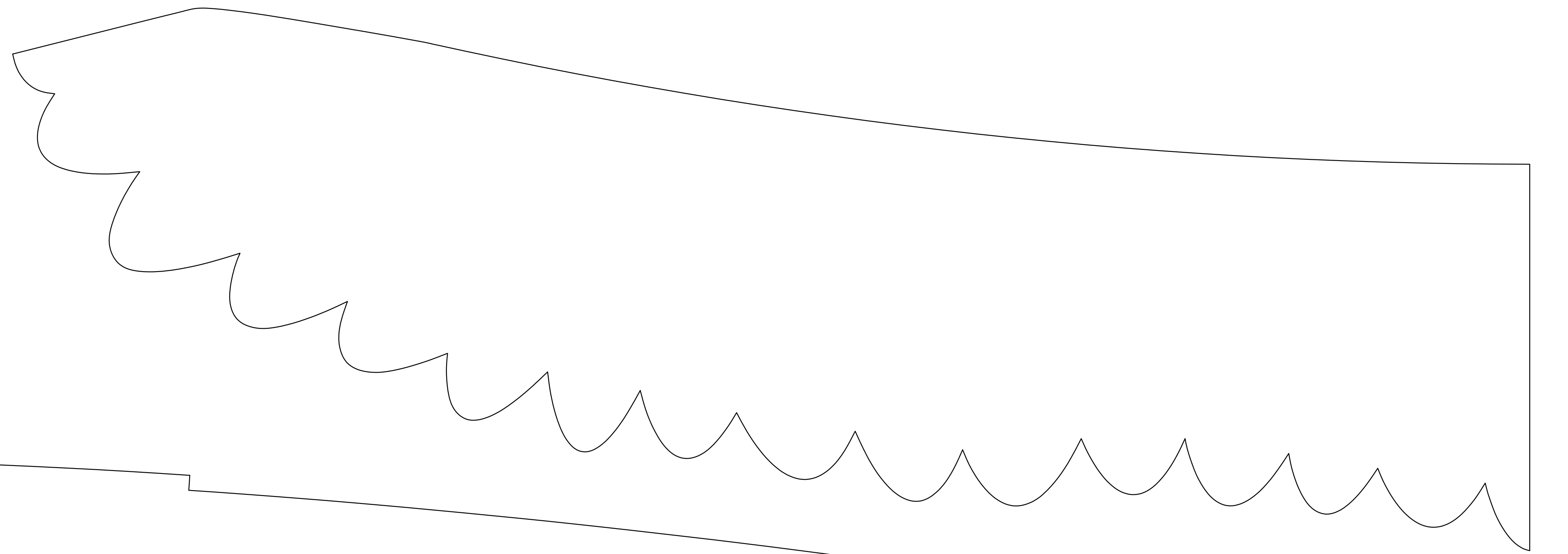
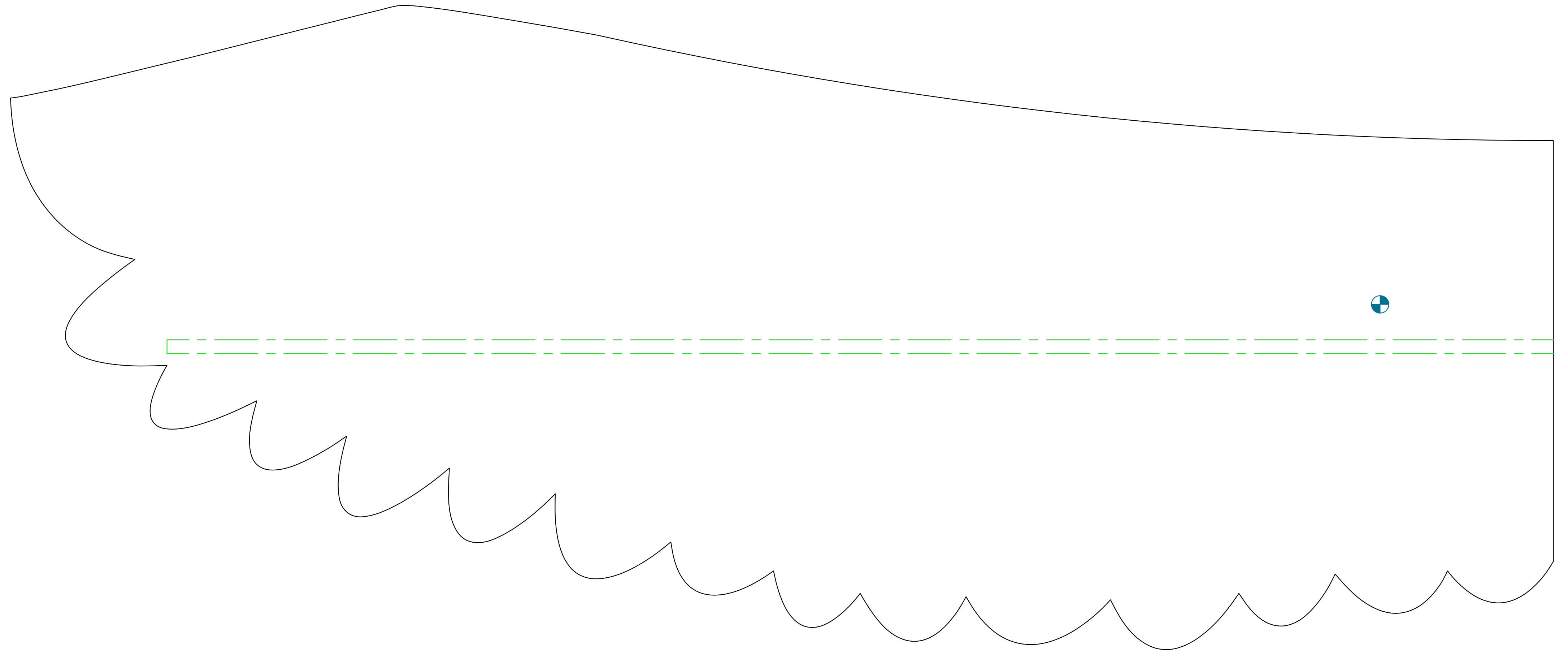
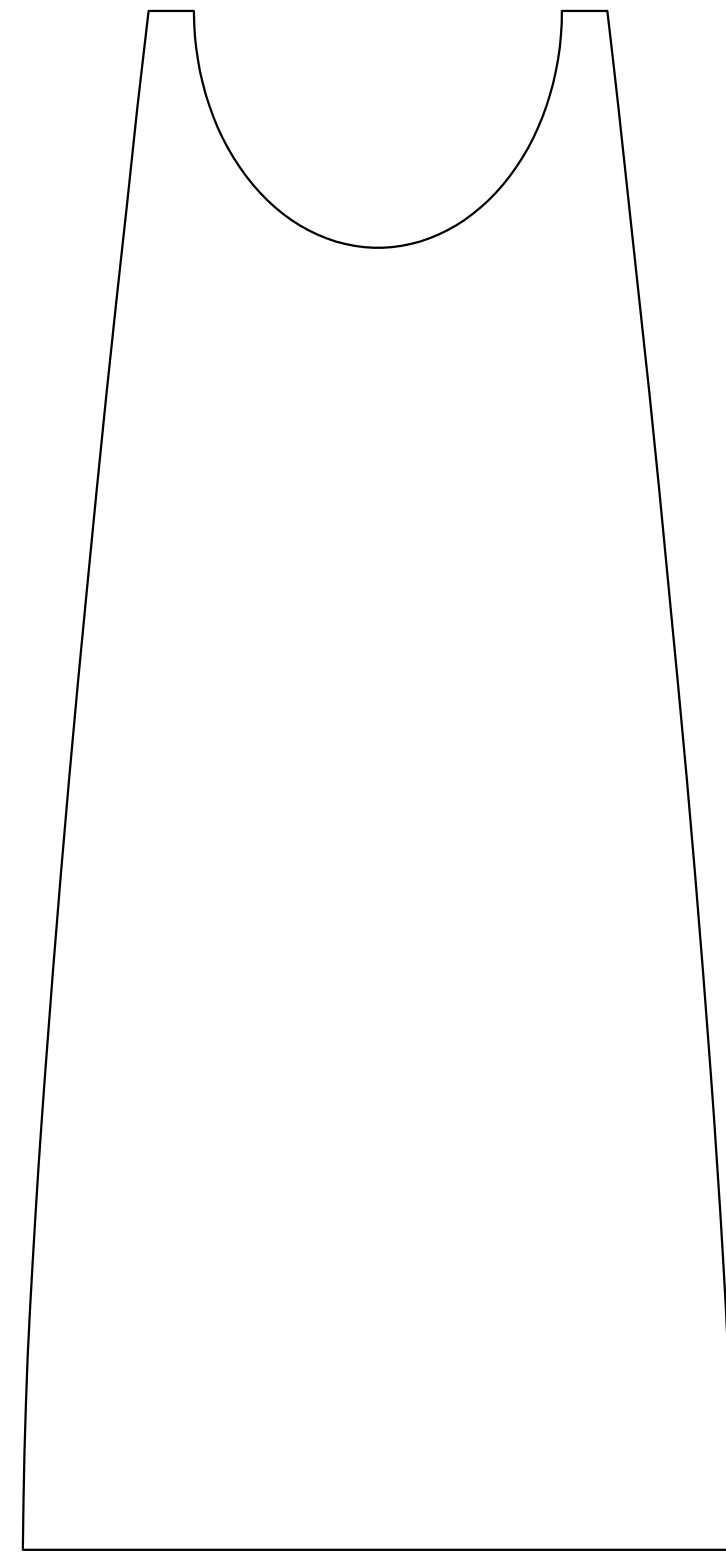

FTF Eagle 56

Designed By: Unknown
Drawing By: Dan Sponholz

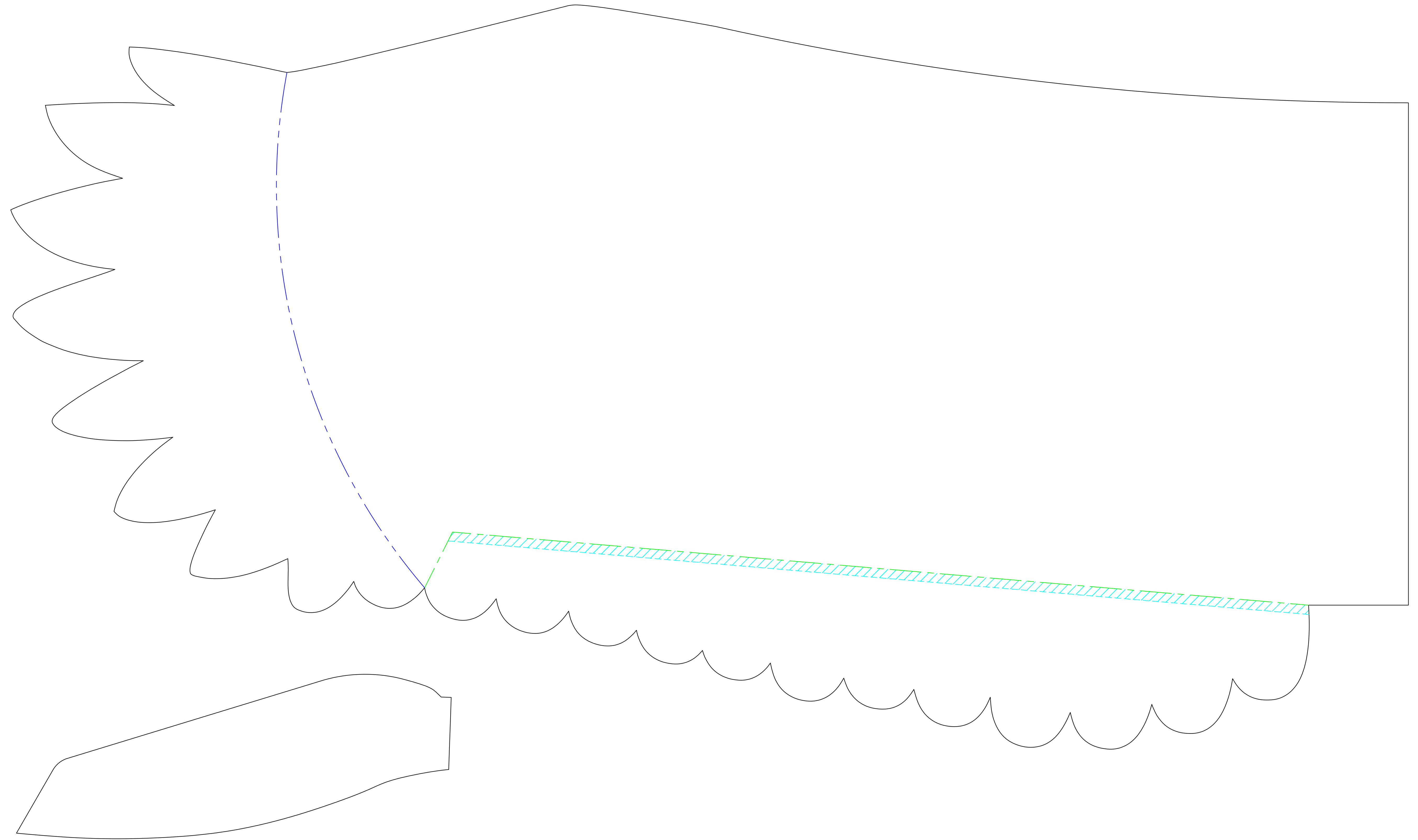

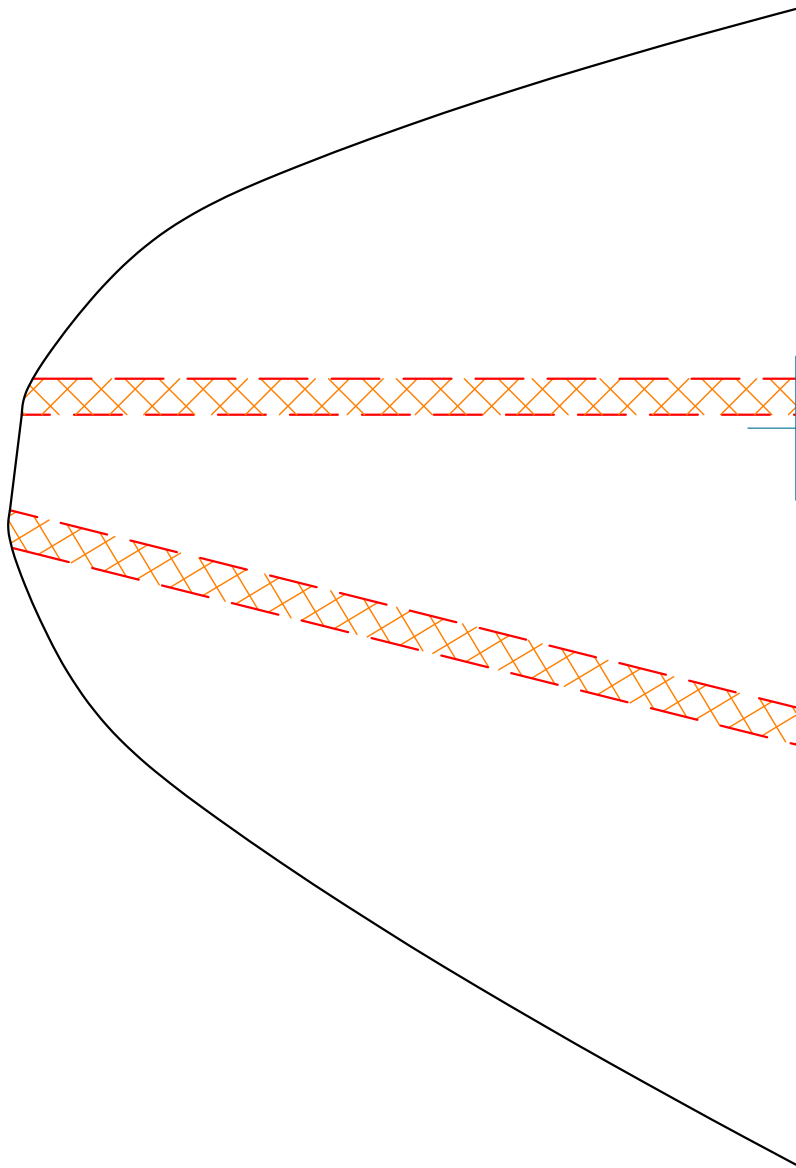

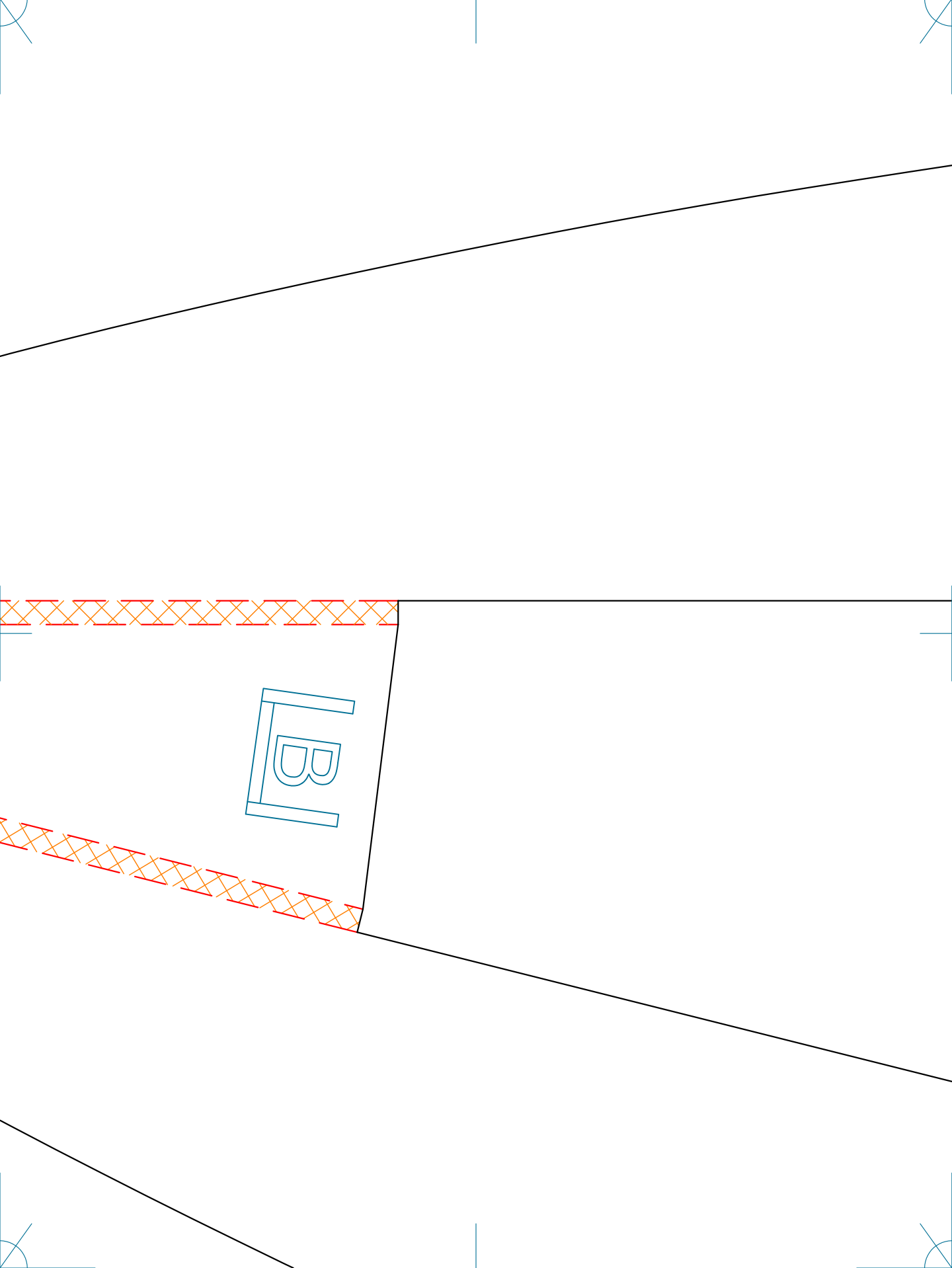

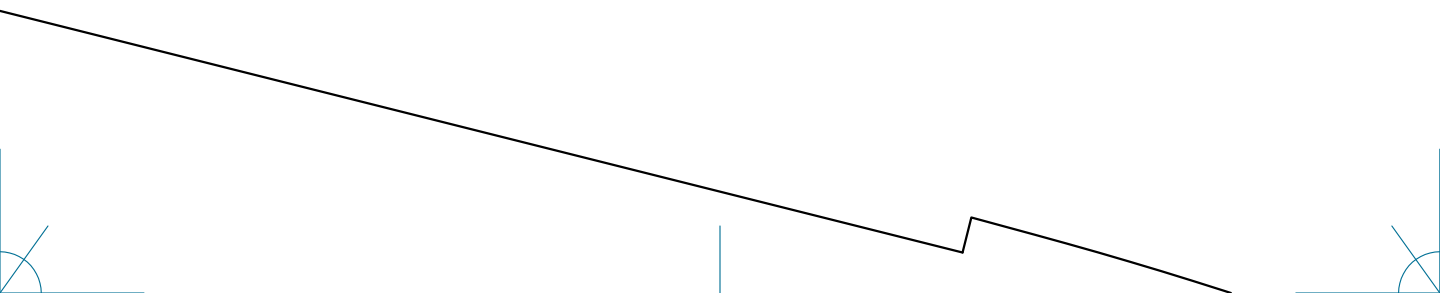
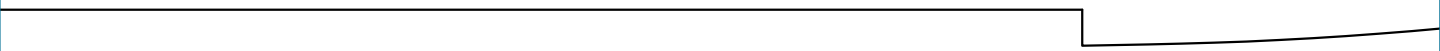

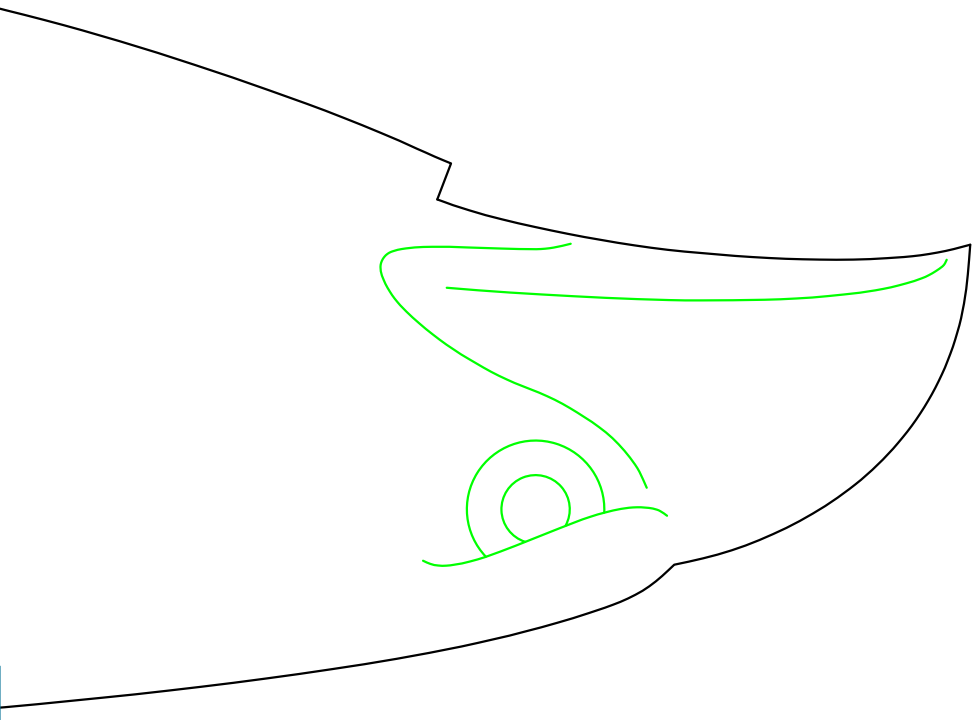

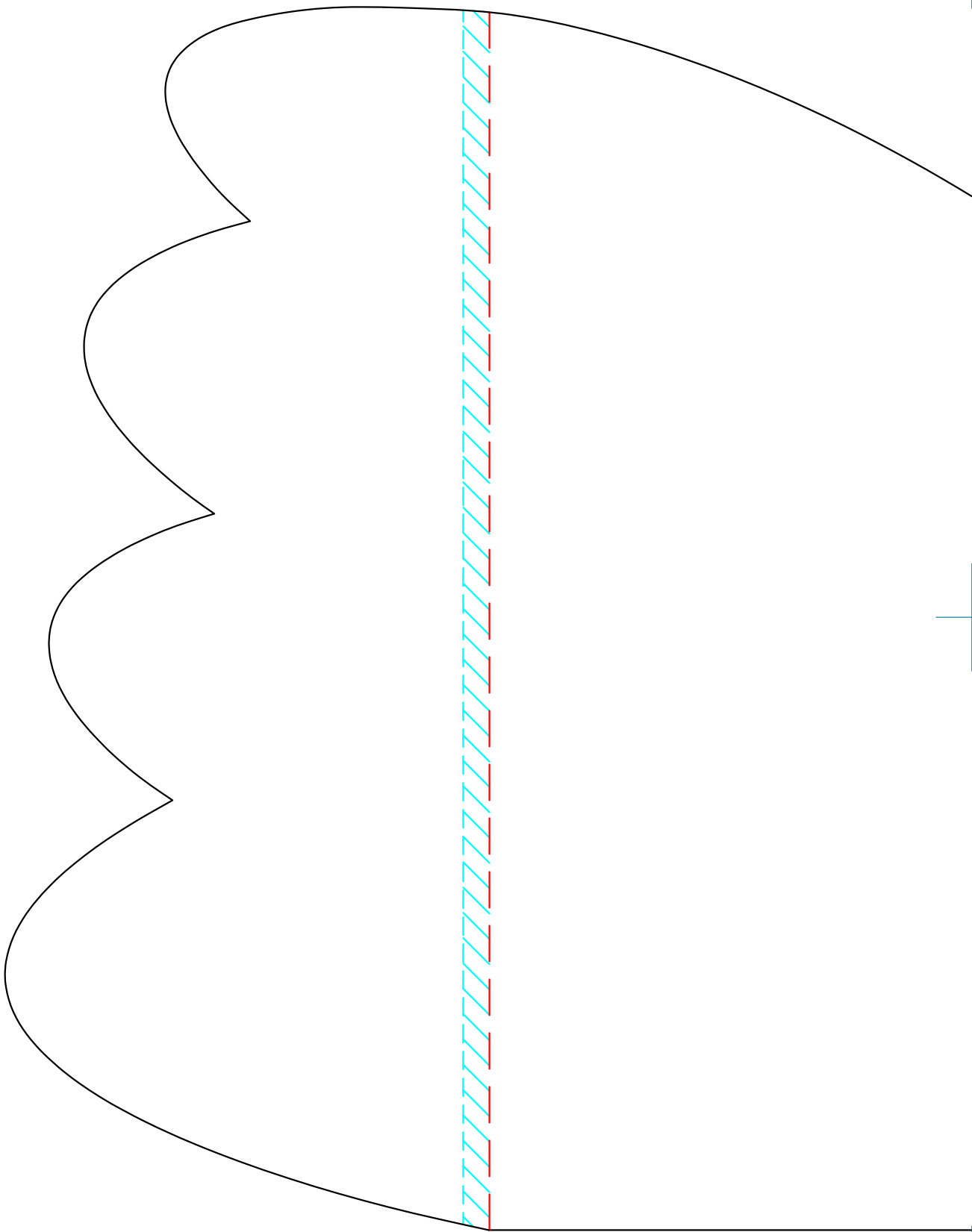



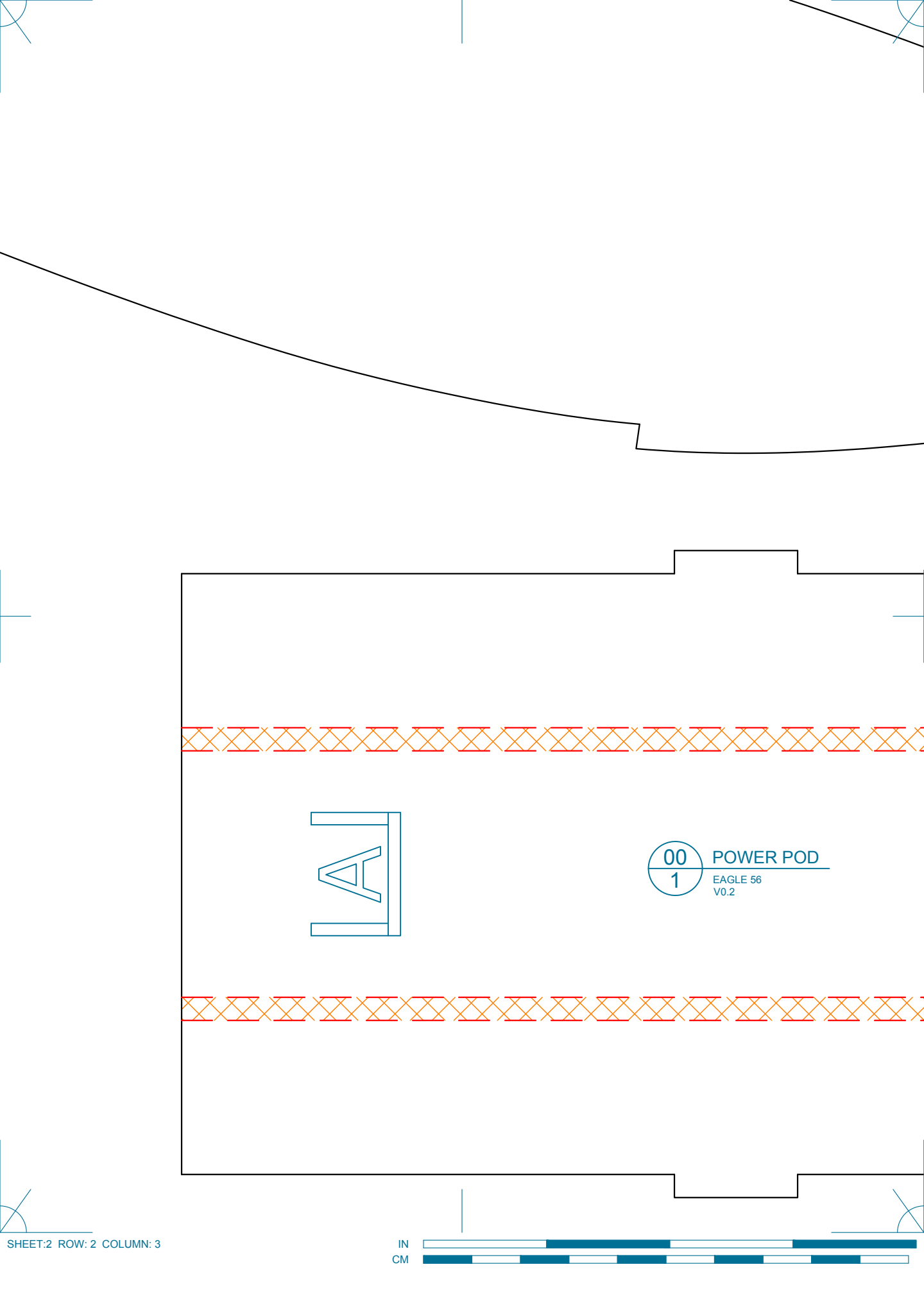

00
1

POWER POD

EAGLE 56
V0.2

