



www.flitetest.com

# FT Mini Charlie

Designed By: Kenny Le

Drawing By: Dan Sponholz

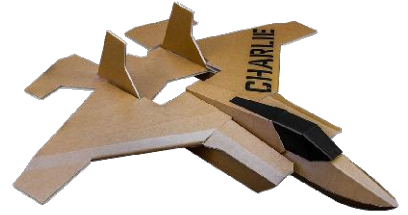

## SPECIFICATIONS

DESCRIPTION		IMPERIAL	METRIC
LENGTH		27.8 in	705 mm
CENTER OF GRAVITY (FROM NOSE)	CG	14 in	355 mm
WING SPAN		28 in	711 mm
WING AREA		156.2 in <sup>2</sup>	10.1 dm <sup>2</sup>
DRY WEIGHT		8.1 oz	230 g
ALL UP WEIGHT	AUW	10.4 oz	295 g
WING LOADING	WL	9.6 oz/ft <sup>2</sup>	29.2 g/dm <sup>2</sup>
WING CUBIC LOADING	WCL	9.2	

## RECOMMENDED SETTINGS

	THROW	EXPO
ELEVONS	16°	30%

Build Skill Level :



Pilot Skill Level :



## SHEET & TILE KEY



1	2	3	4
5	6	7	8

9	10	11	12
13	14	15	16

17	18	19	20
21	<del>22</del>	<del>23</del>	<del>24</del>

# DRAWING KEY

## FOLD TYPES

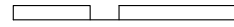
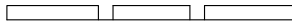
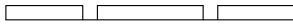
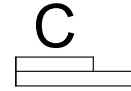
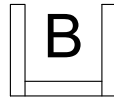
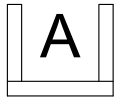

A - FOLD (ABOVE)

B - FOLD (BESIDE)

C - FOLD (COVER)

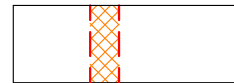
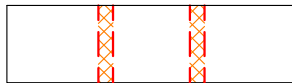
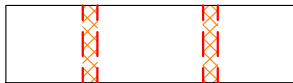

## LINE TYPE/COLOR

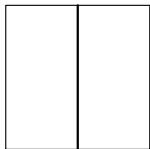

CUT

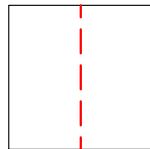
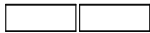

50% SCORE

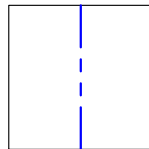
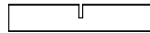

CREASE

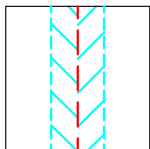
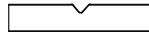

45° DOUBLE  
BEVEL

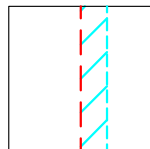

45° SINGLE  
BEVEL

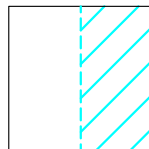

EDGE  
BEVEL

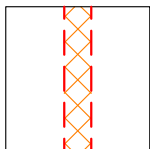

CAVITY

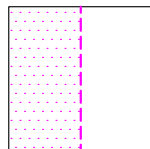

REMOVE  
PAPER

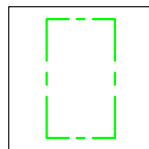
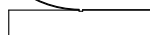

REFERENCE/  
OPTIONAL

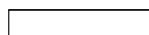

## SYMBOLS

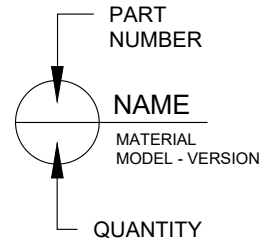

DOWEL  
HOLE



CENTER  
OF  
GRAVITY  
(CG)

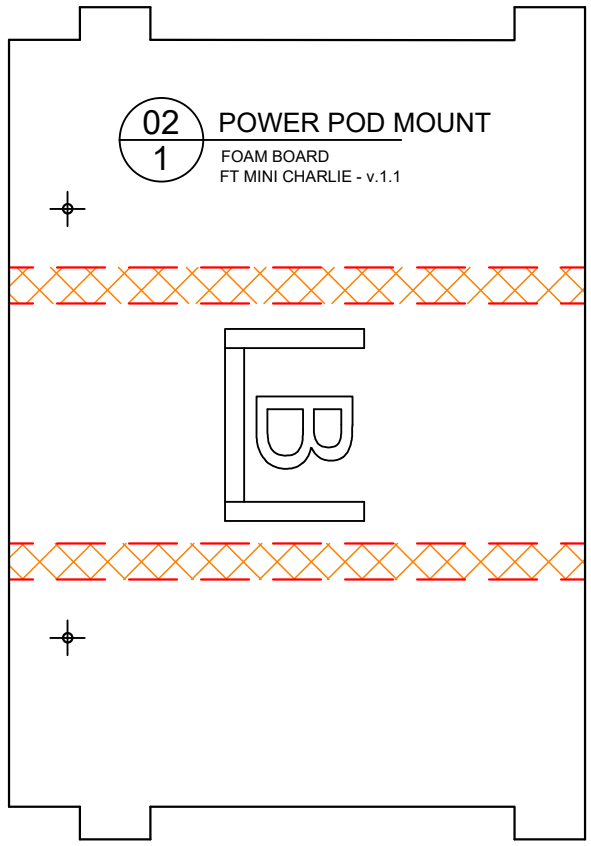
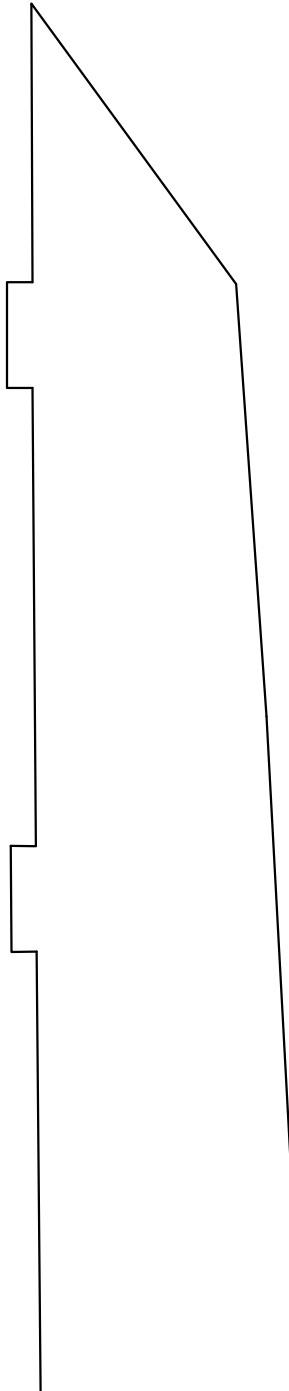

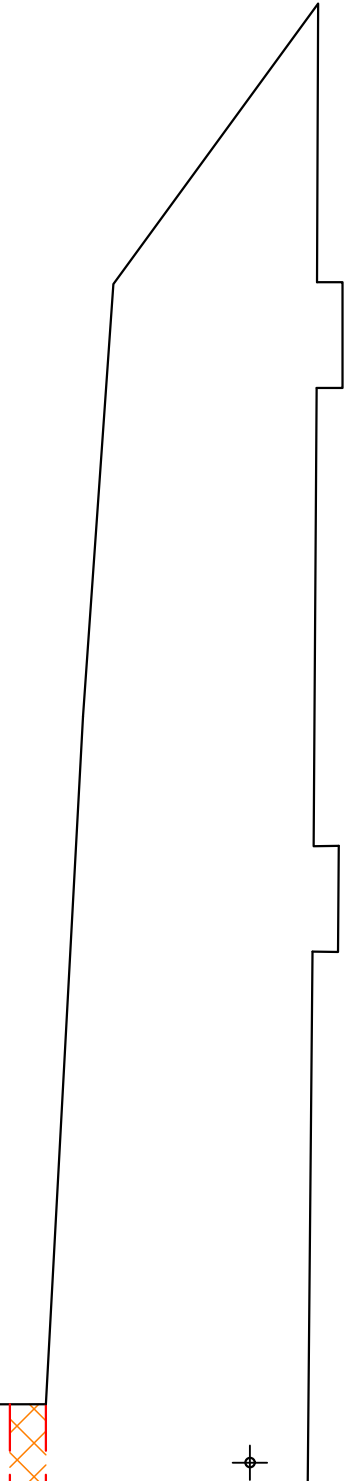

03 POWER POD  
1 FOAM BOARD  
FT MINI CHARLIE - v.1.1



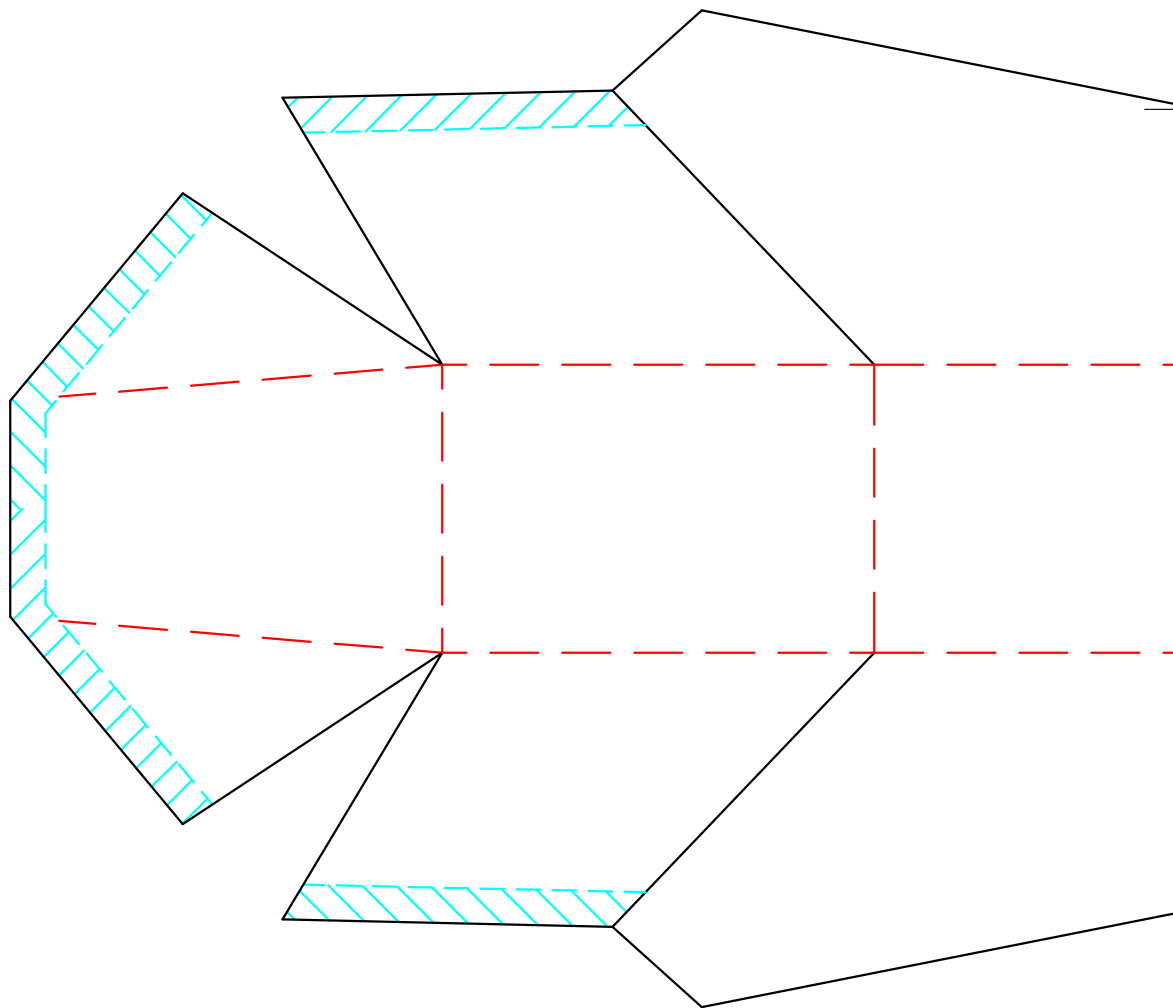
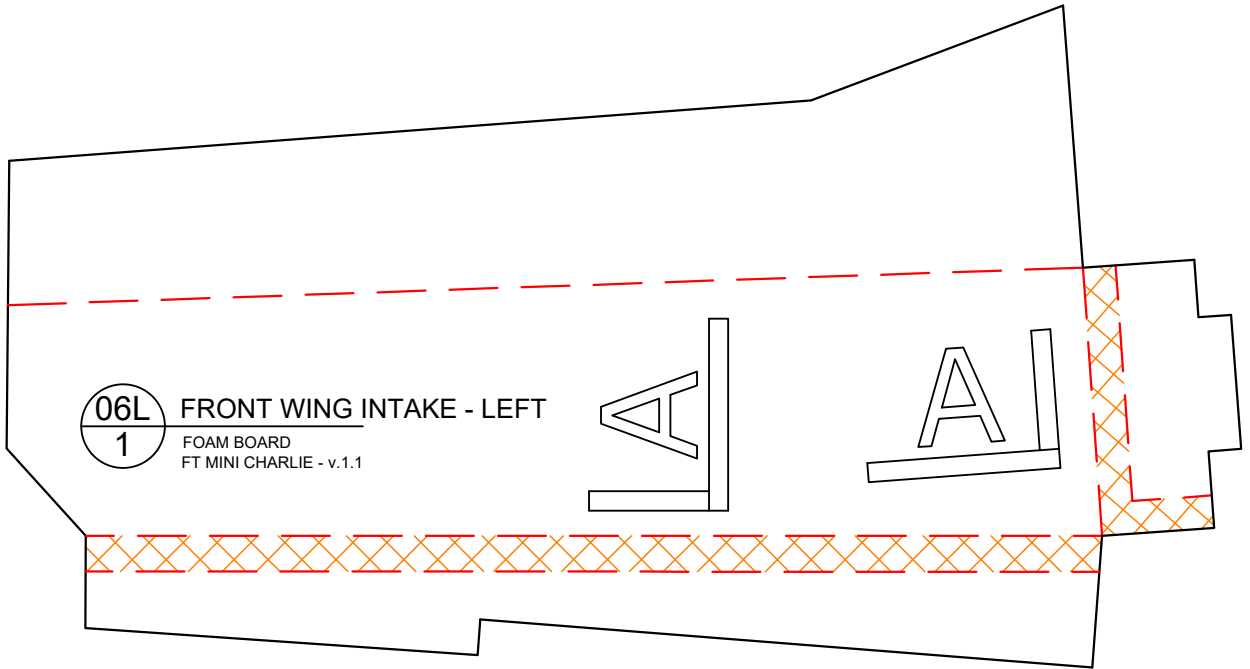

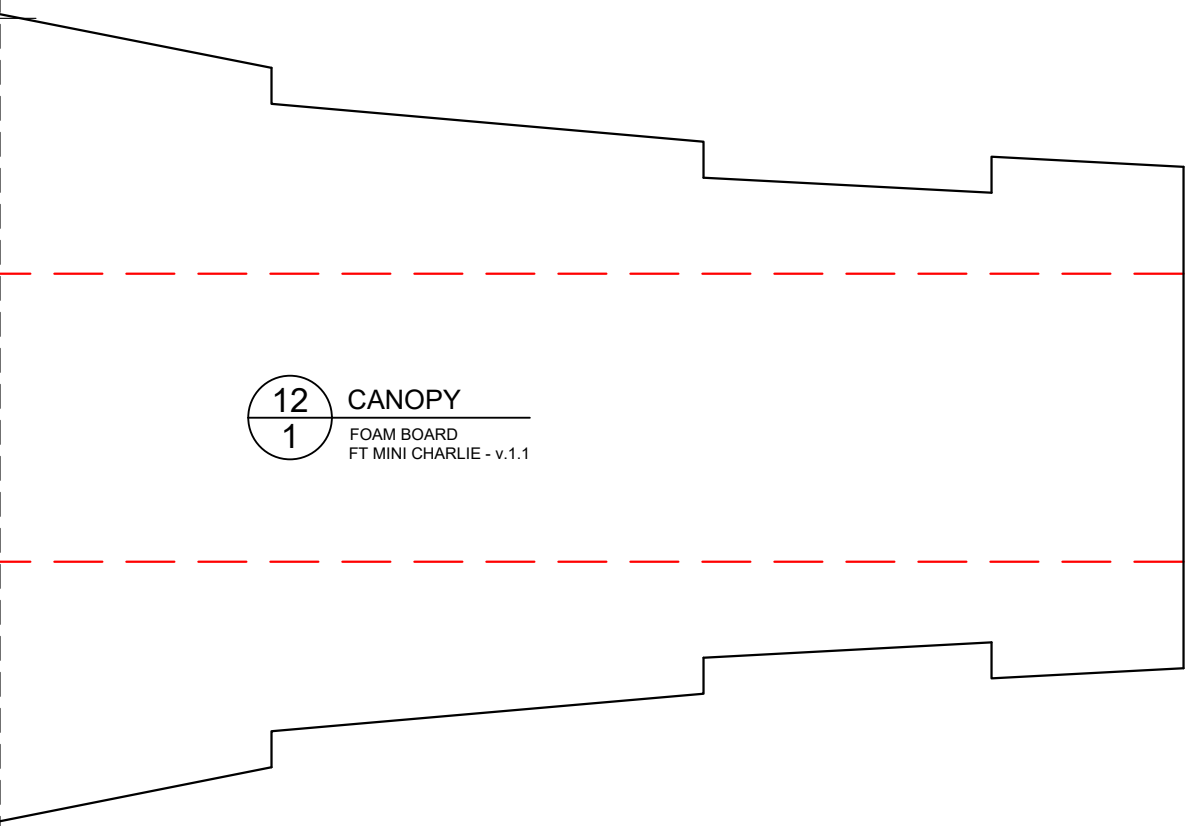
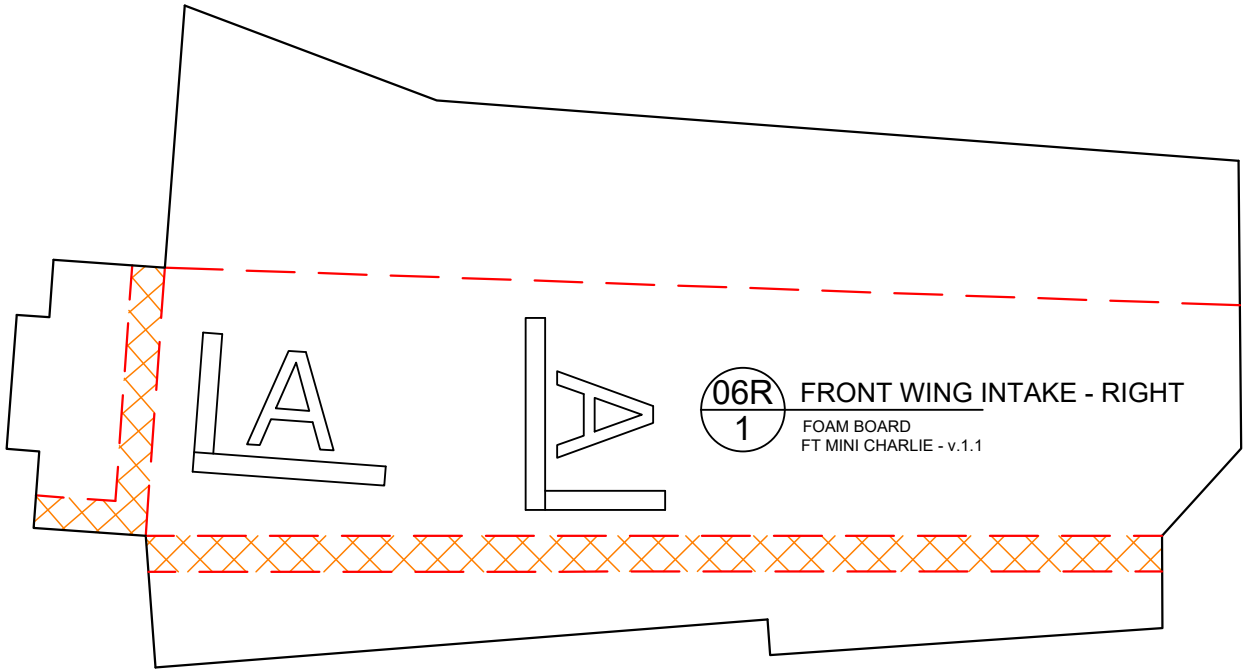

01 BELLY PAN  
FOAM BOARD  
FT MINI CHARLIE - v.1.1

B

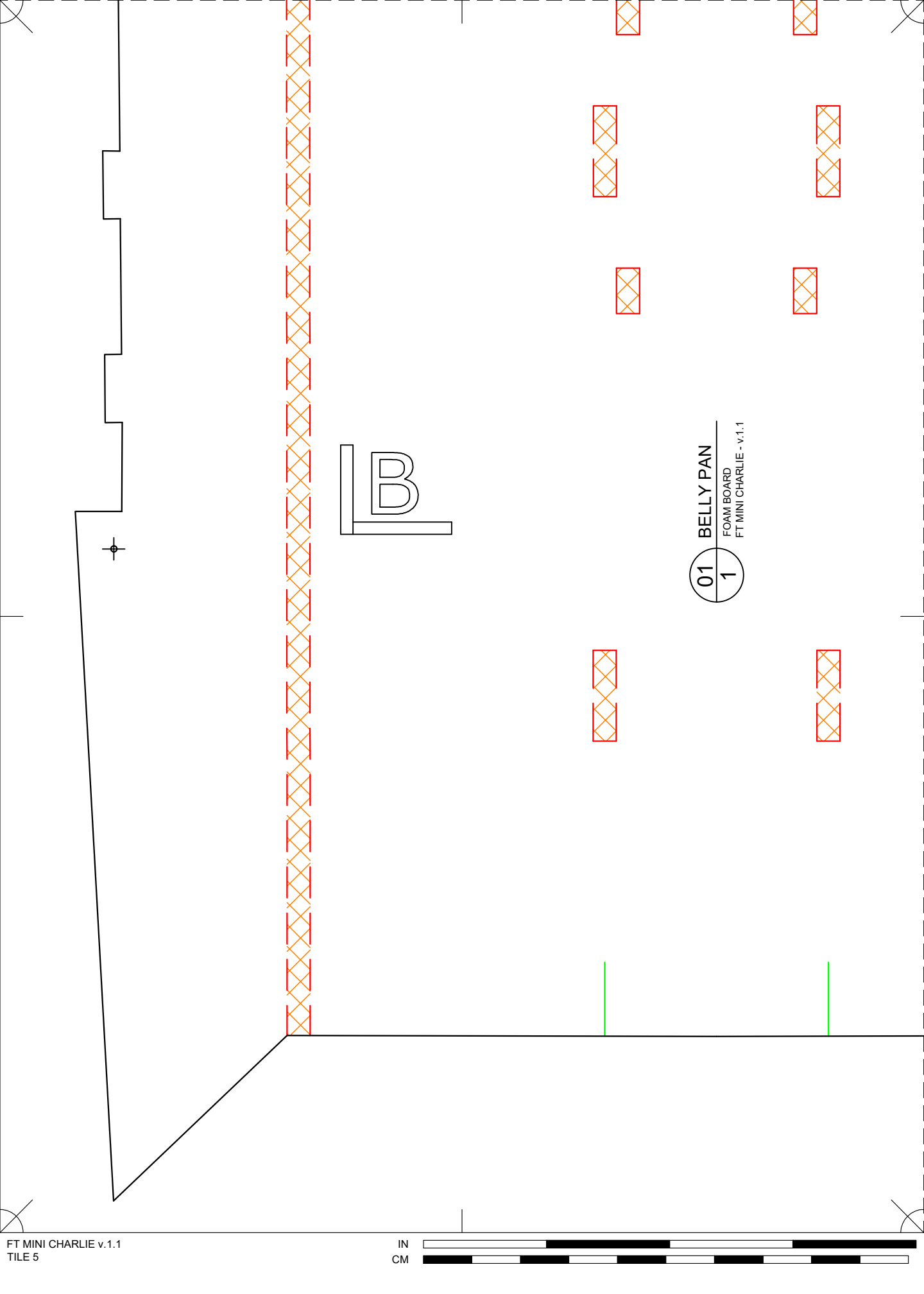

B

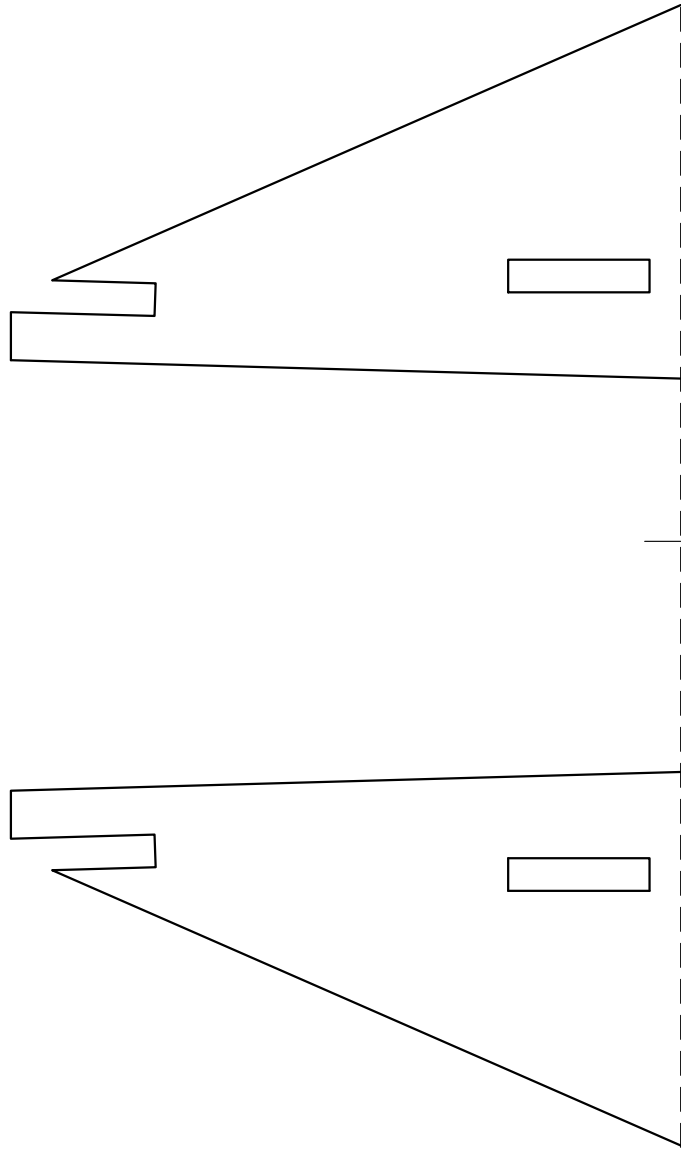



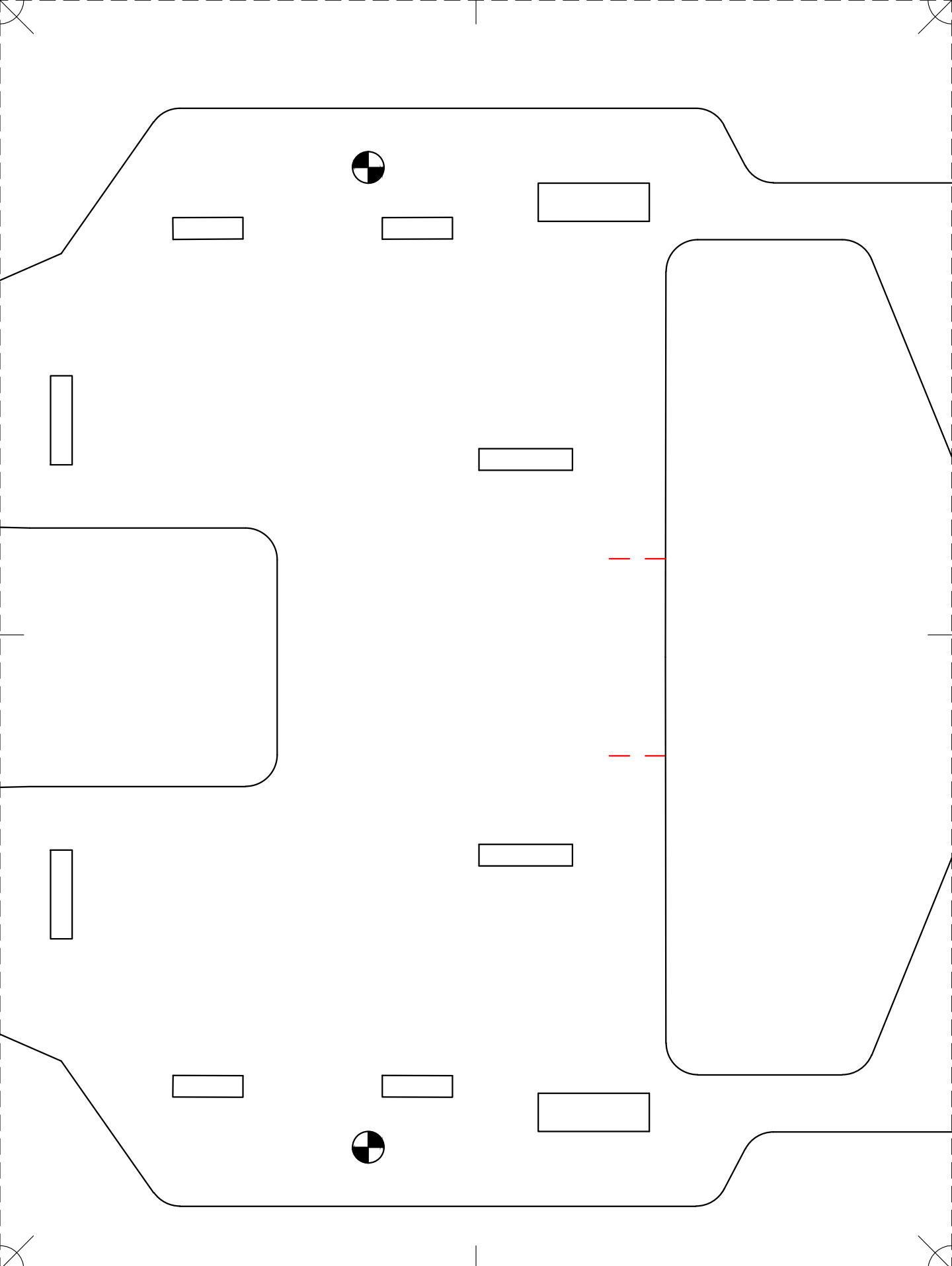

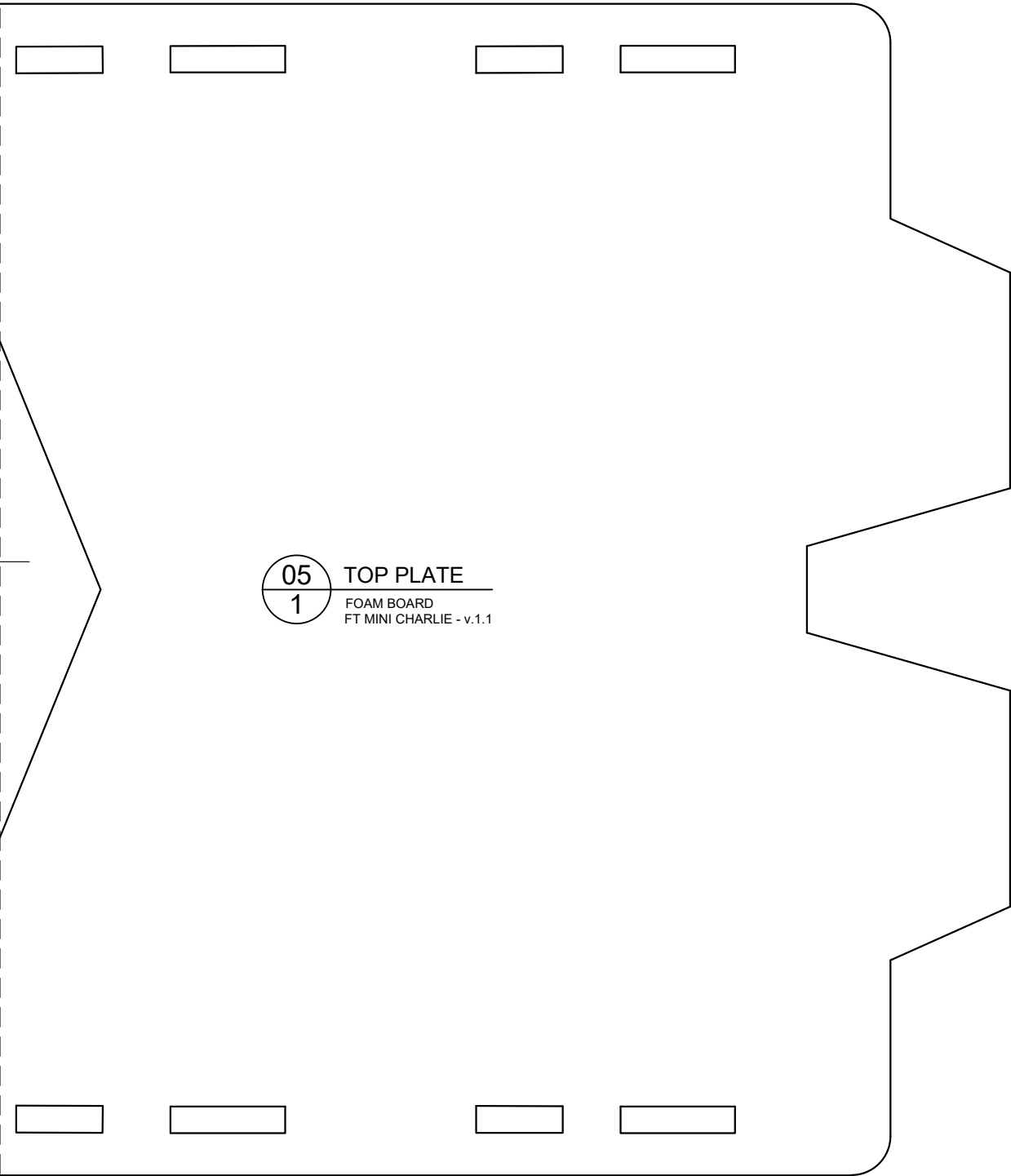

05  
1

---

TOP PLATE  
FOAM BOARD  
FT MINI CHARLIE - v.1.1

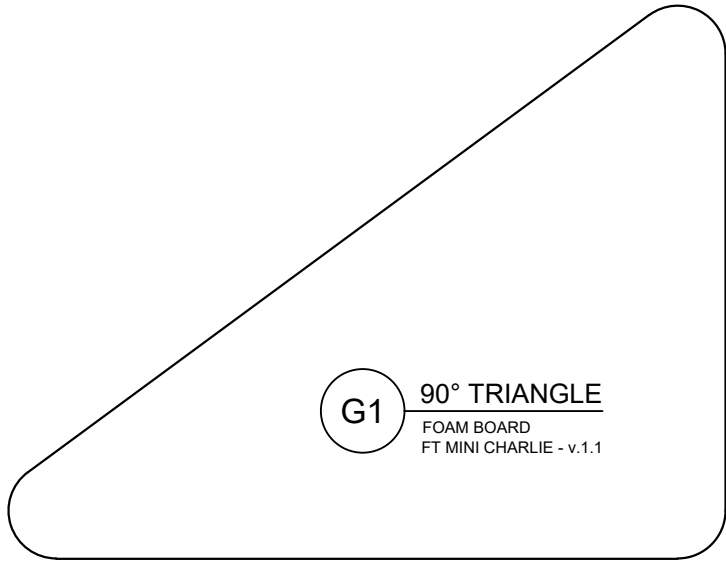

G1 90° TRIANGLE  
FOAM BOARD  
FT MINI CHARLIE - v.1.1

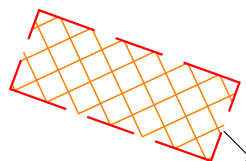
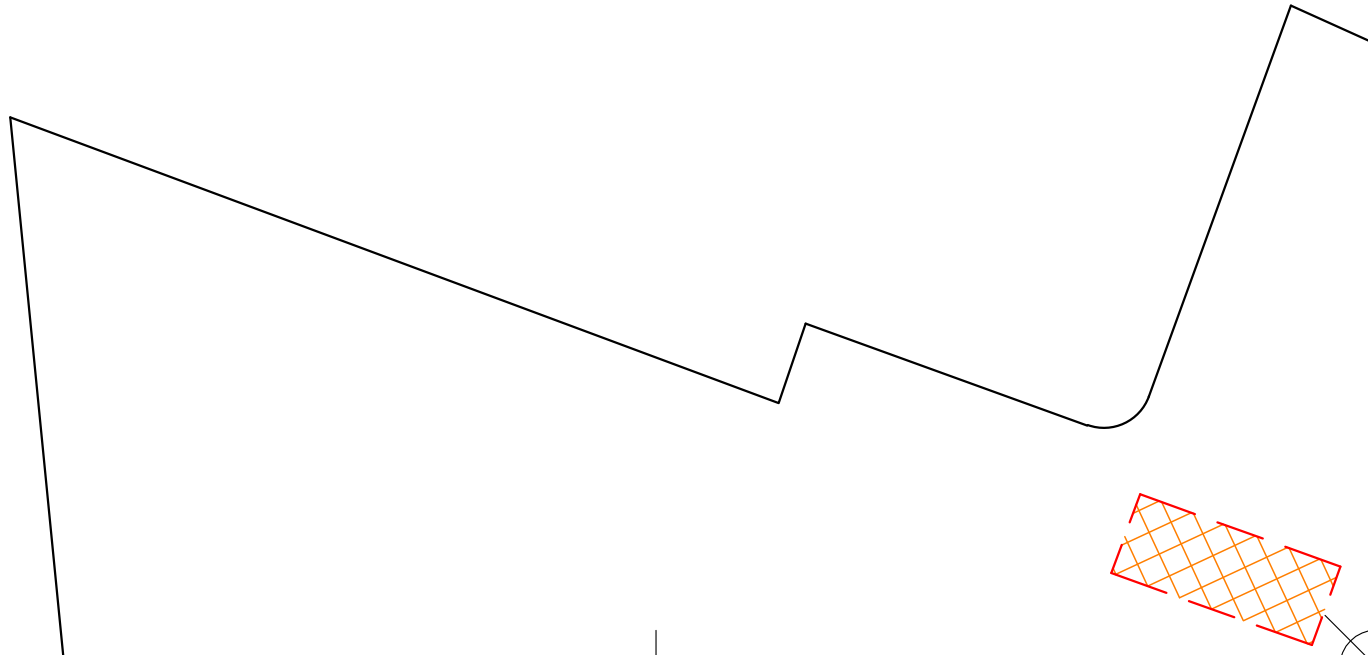

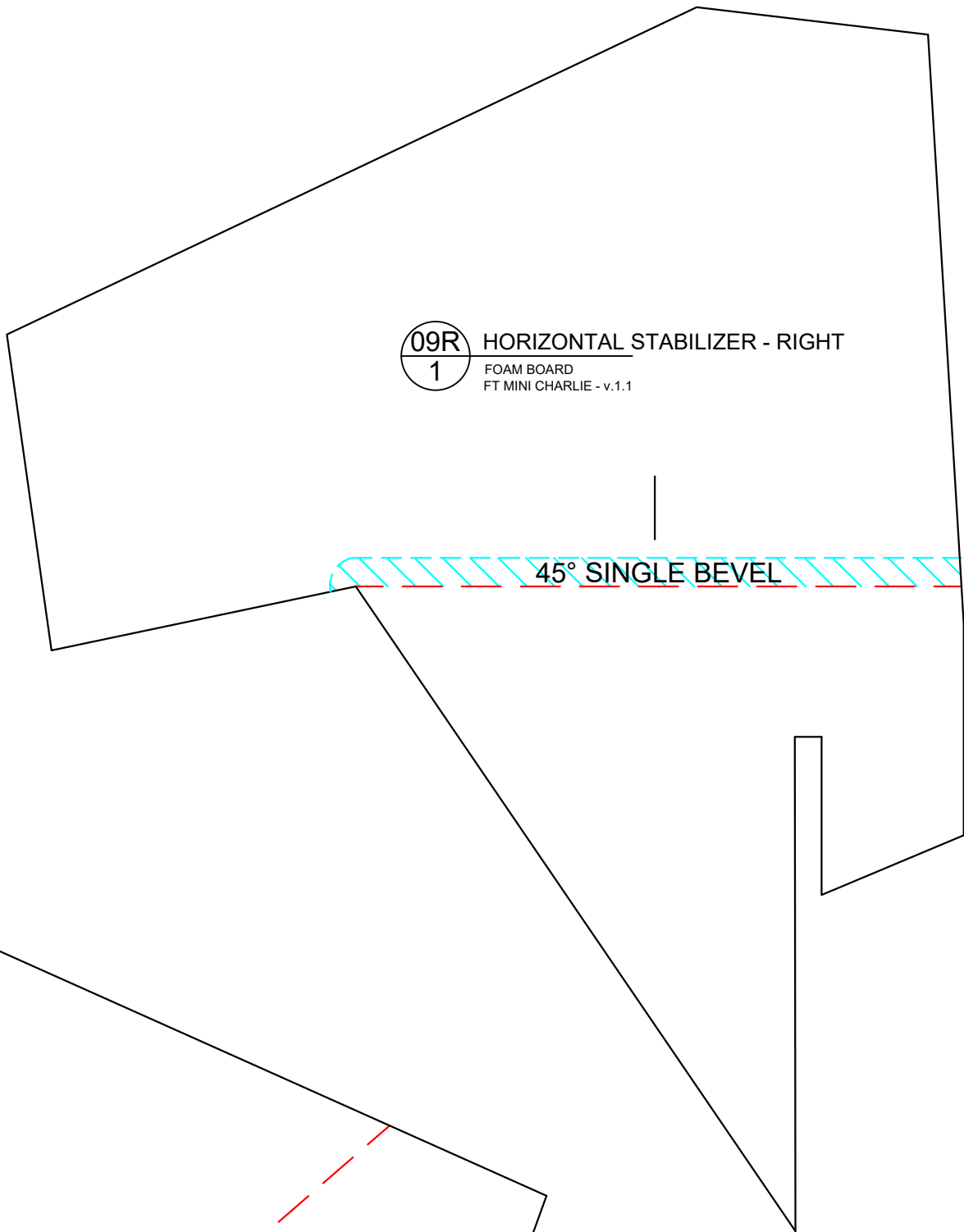

09R  
1

HORIZONTAL STABILIZER - RIGHT

FOAM BOARD  
FT MINI CHARLIE - v.1.1

45° SINGLE BEVEL

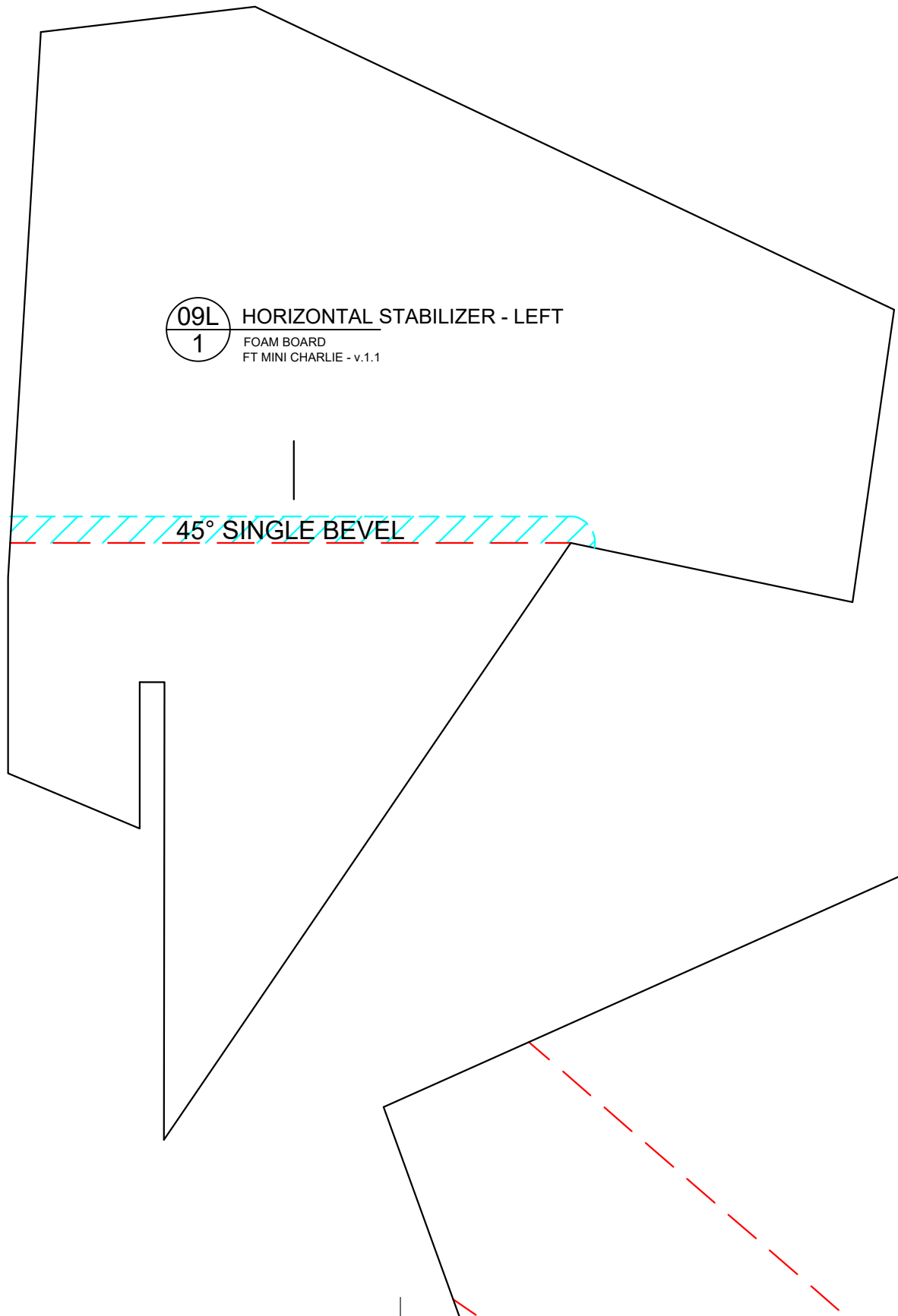

09L  
1

HORIZONTAL STABILIZER - LEFT

FOAM BOARD  
FT MINI CHARLIE - v.1.1

45° SINGLE BEVEL

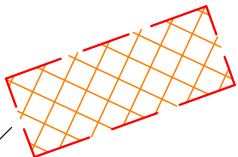
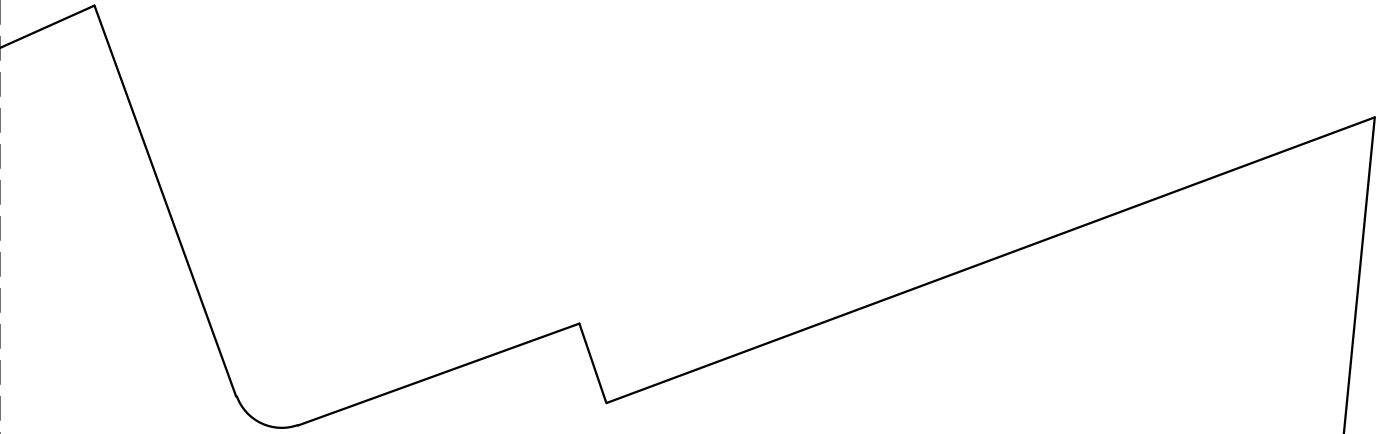

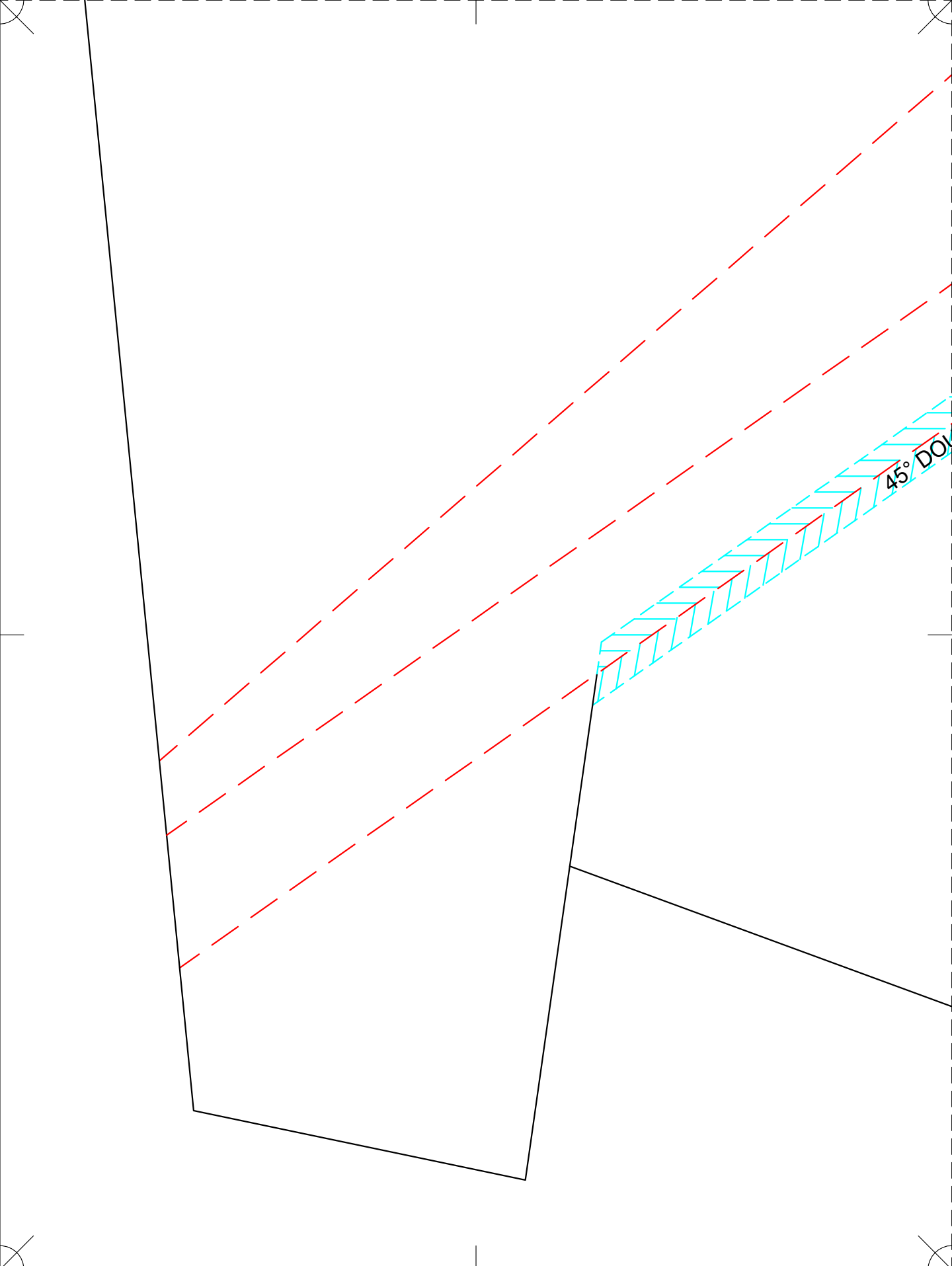

45° DOWN

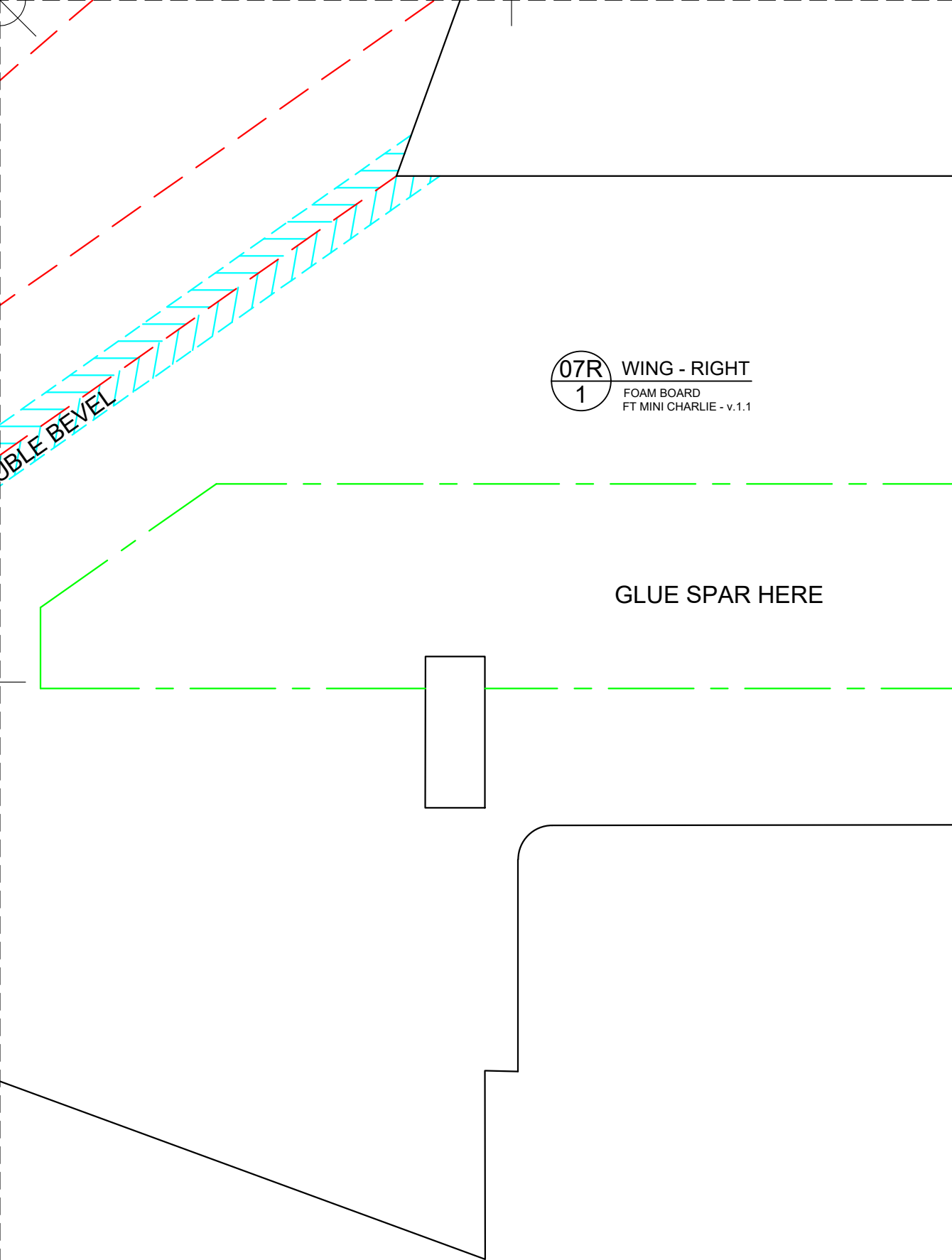

07R WING - RIGHT  
1 FOAM BOARD  
FT MINI CHARLIE - v.1.1



07L  
1

WING - LEFT  
FOAM BOARD  
FT MINI CHARLIE - v.1.1

GLUE SPAR HERE

45° DOUBLE

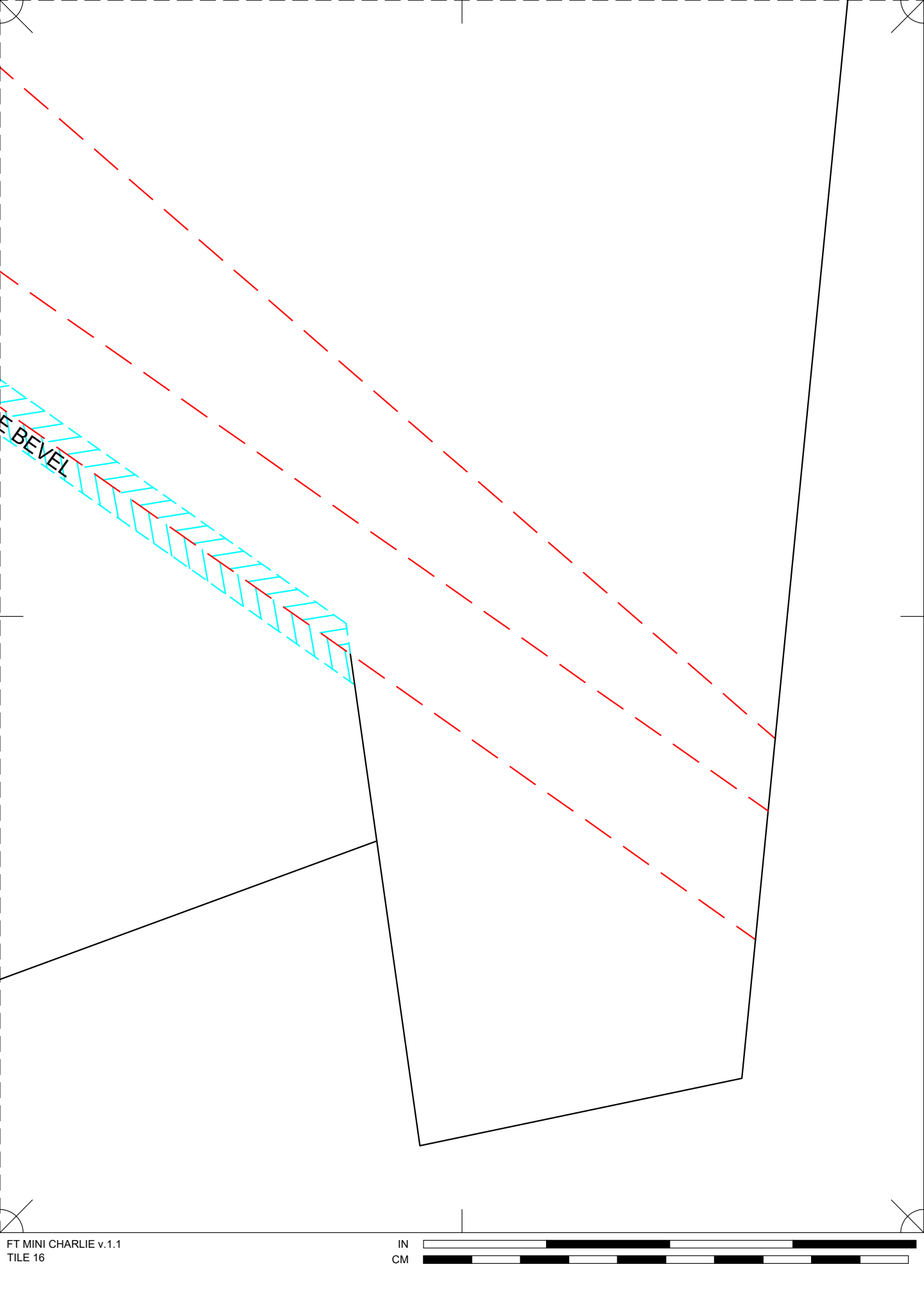

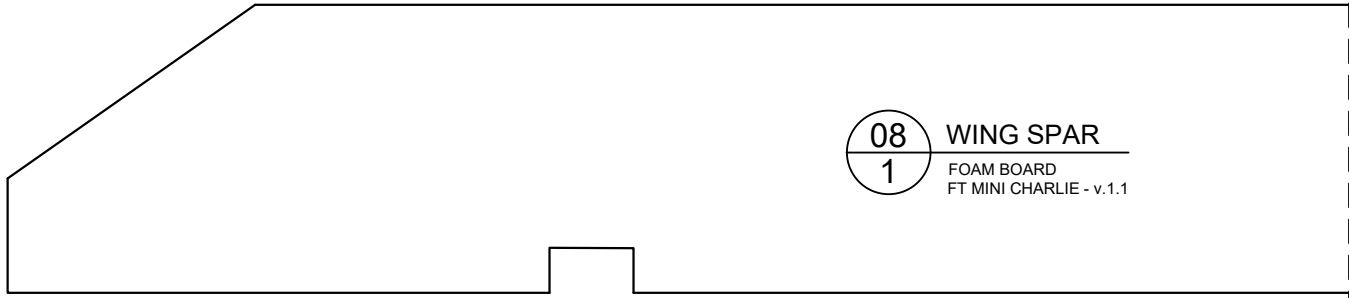

**08** WING SPAR  
**1** FOAM BOARD  
FT MINI CHARLIE - v.1.1

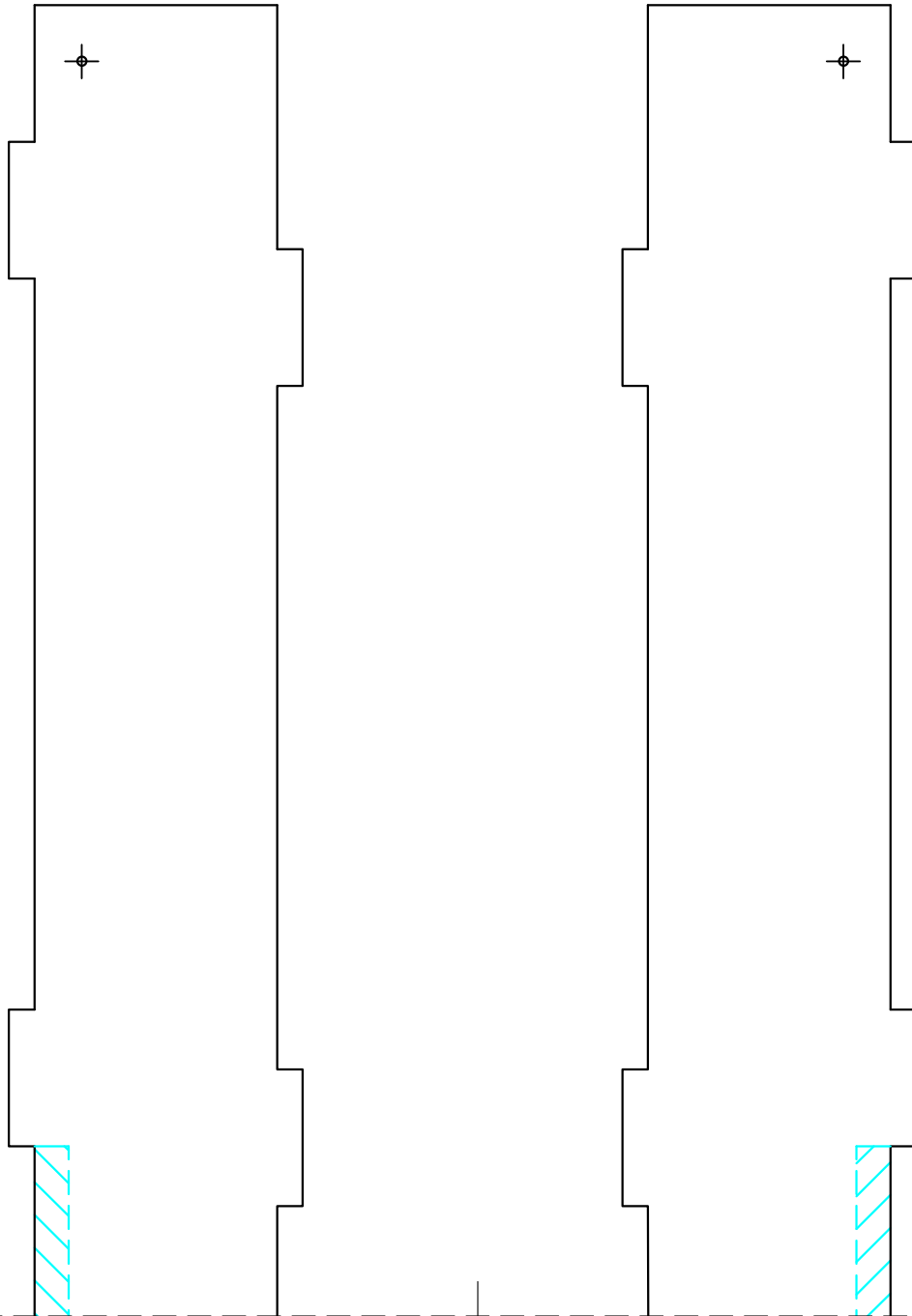

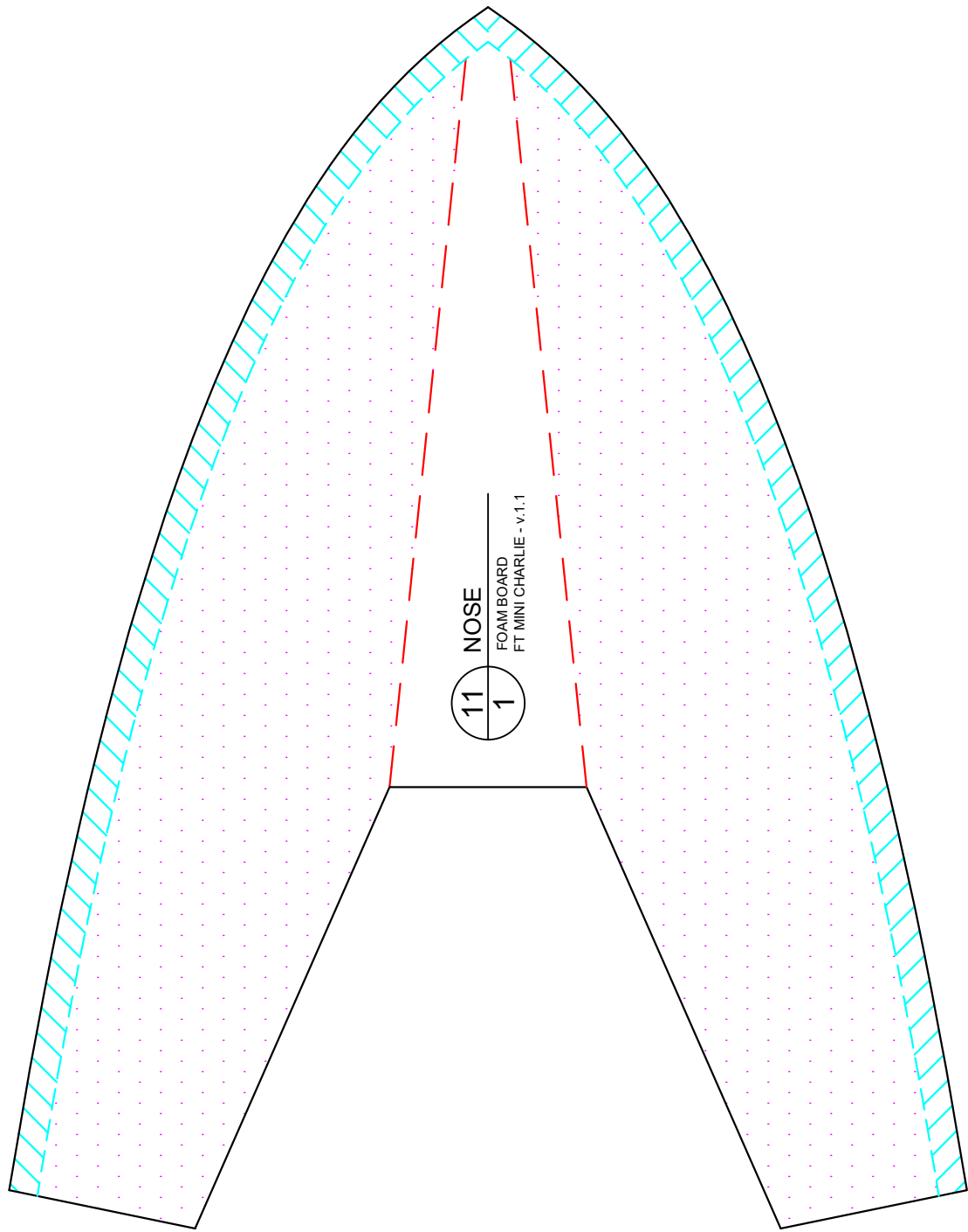
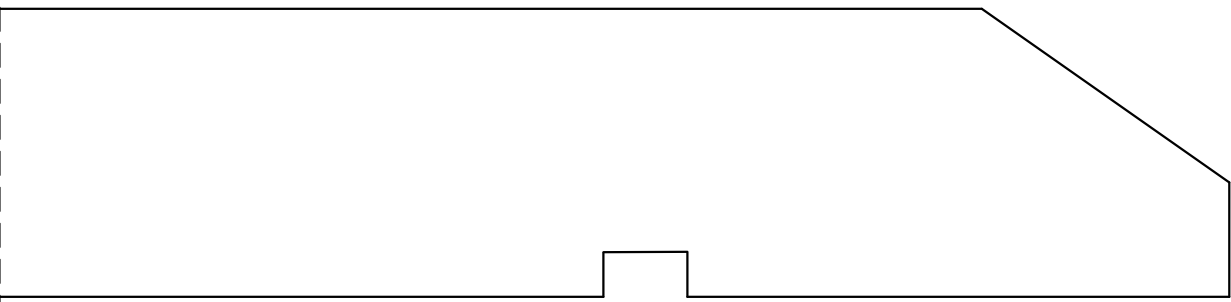

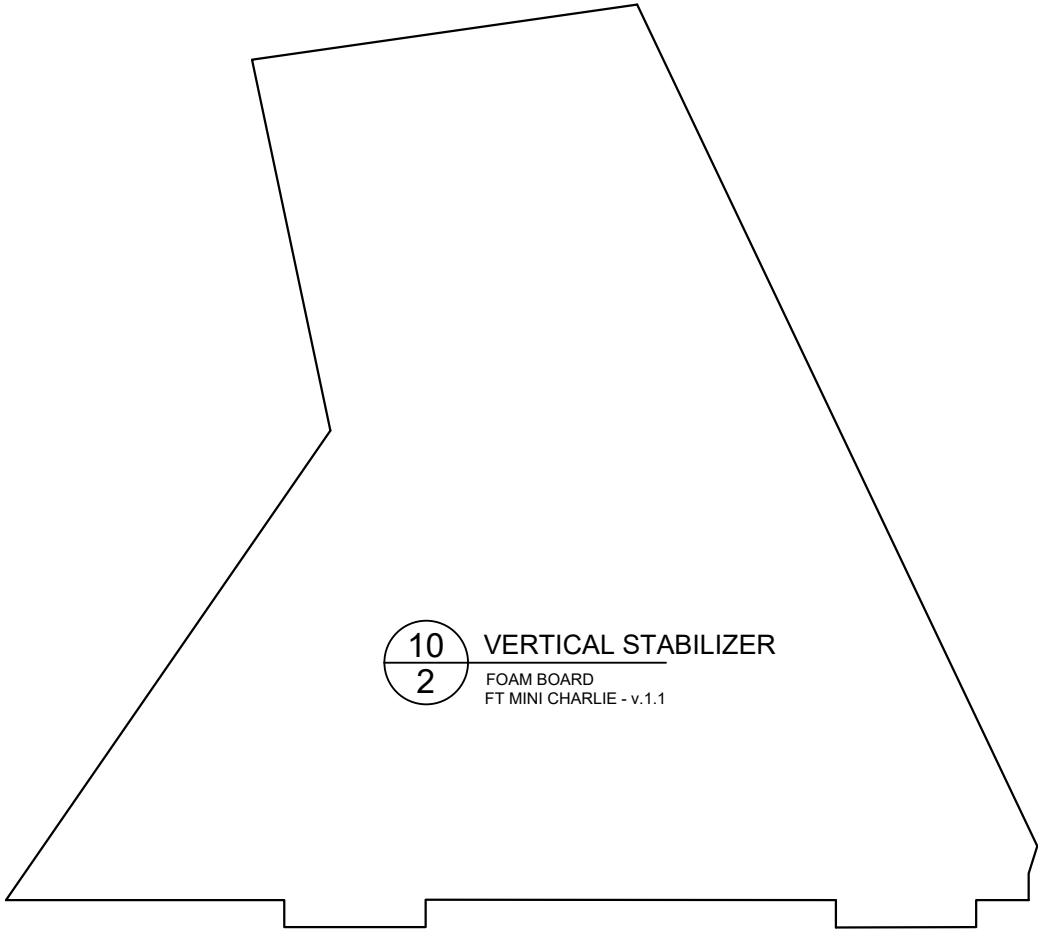

10  
2

**VERTICAL STABILIZER**

FOAM BOARD  
FT MINI CHARLIE - v.1.1

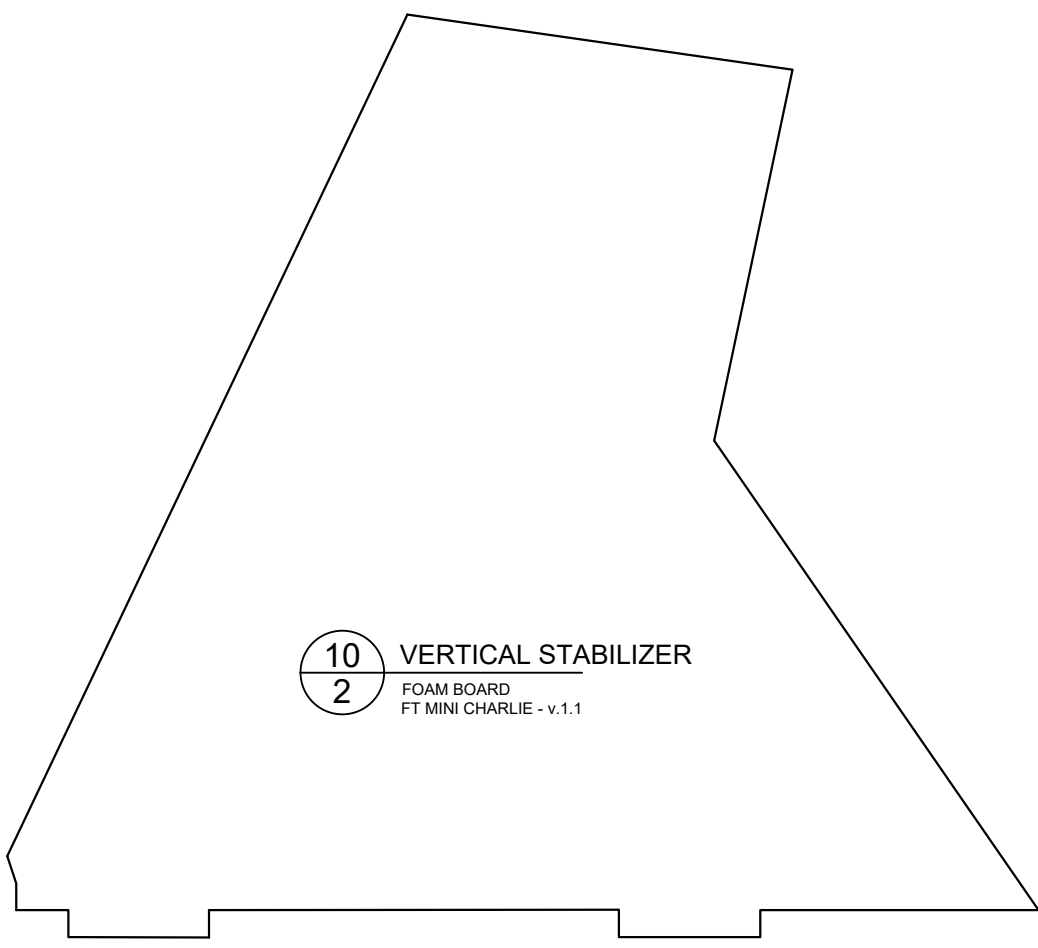

**10** VERTICAL STABILIZER  
**2** FOAM BOARD  
FT MINI CHARLIE - v.1.1

04 LOWER FUSELAGE  
FOAM BOARD  
FT MINI CHARLIE - v.1.1

