

temporary horizontal spacer

black = cut

red = score 50%

blue = lightly crease

light blue = Information

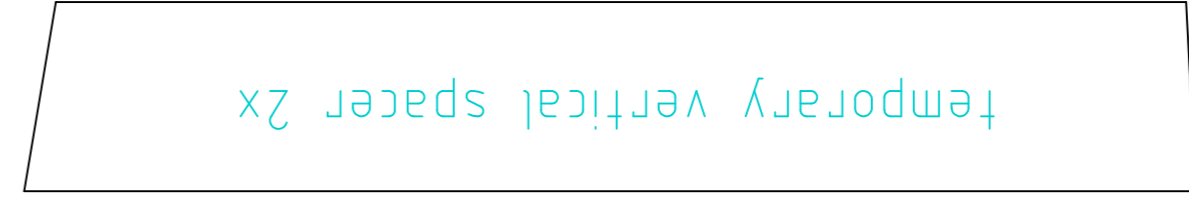
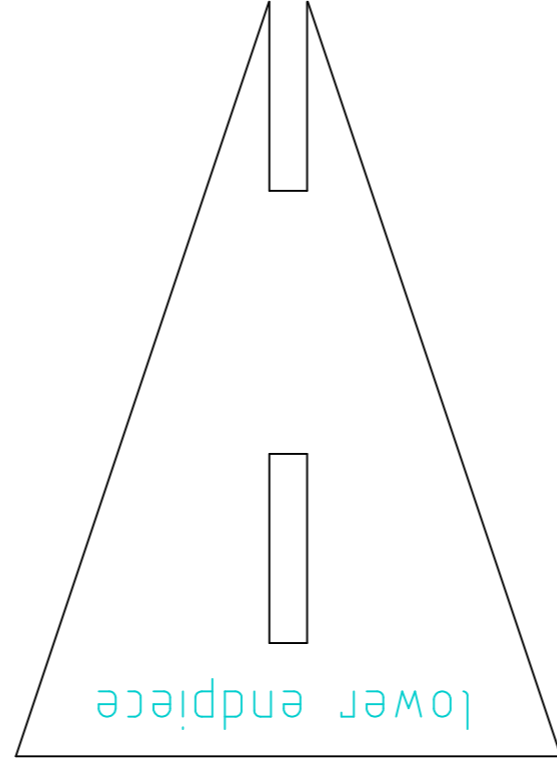
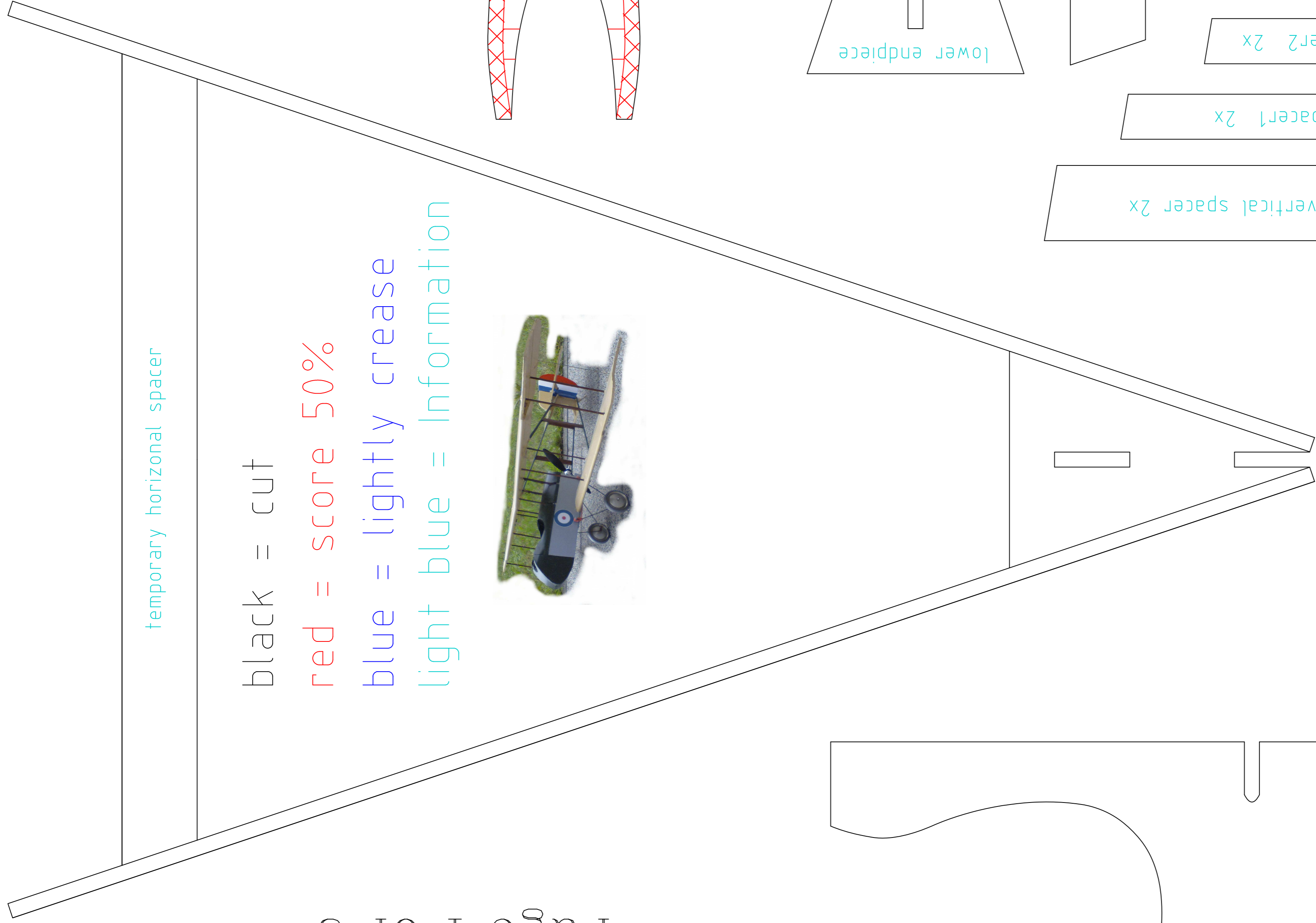
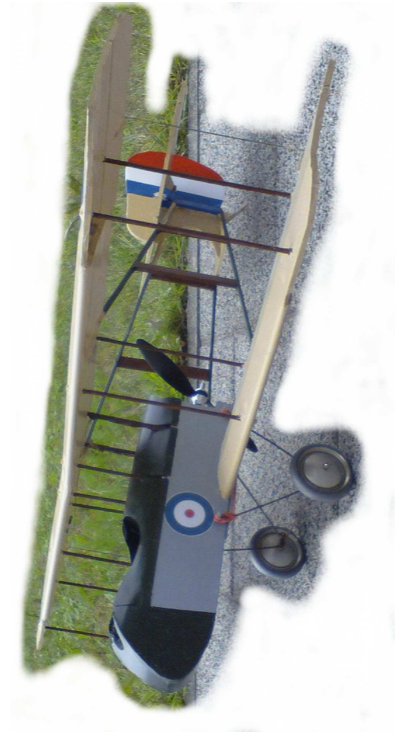

temporary horizontal spacer 2x

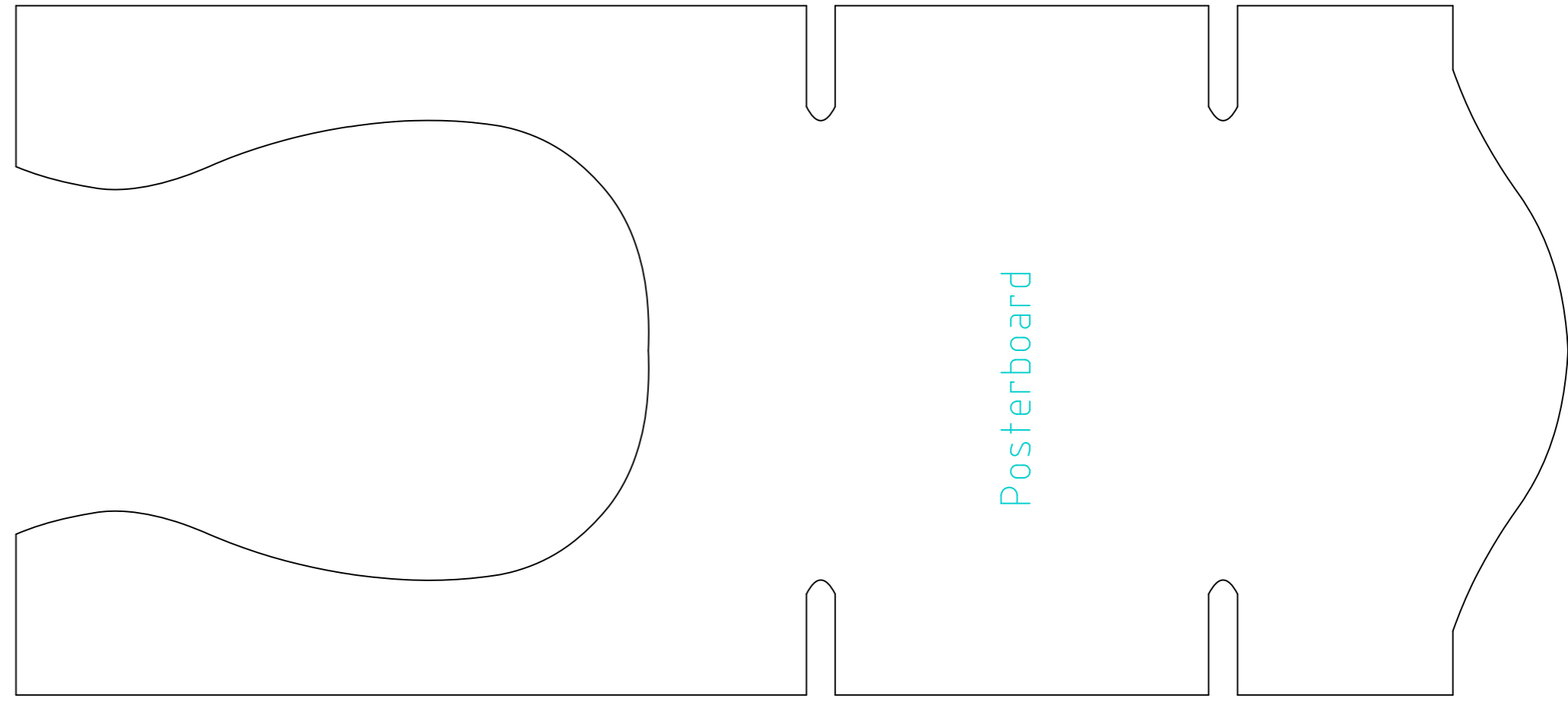
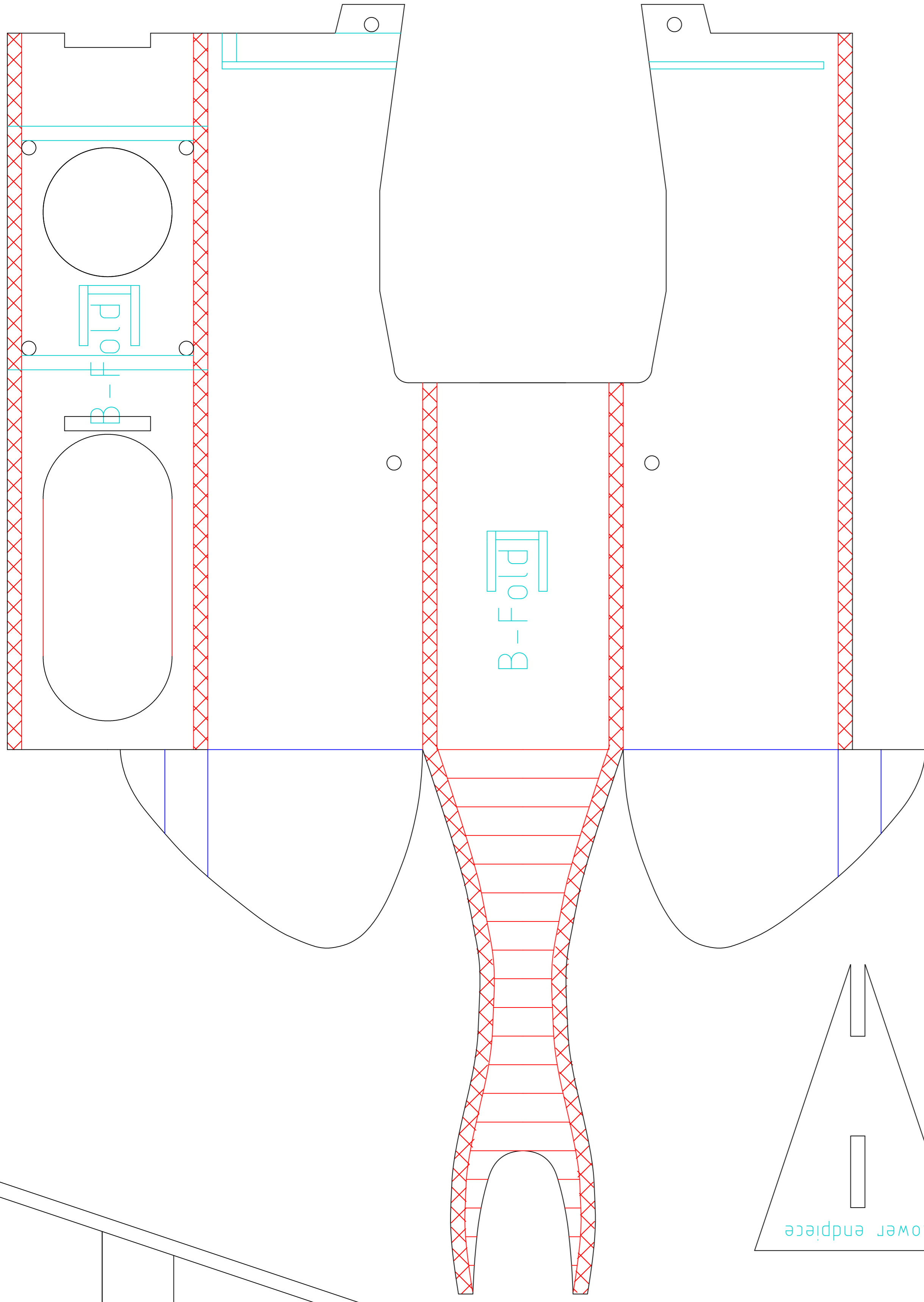

Plywood 25 mm

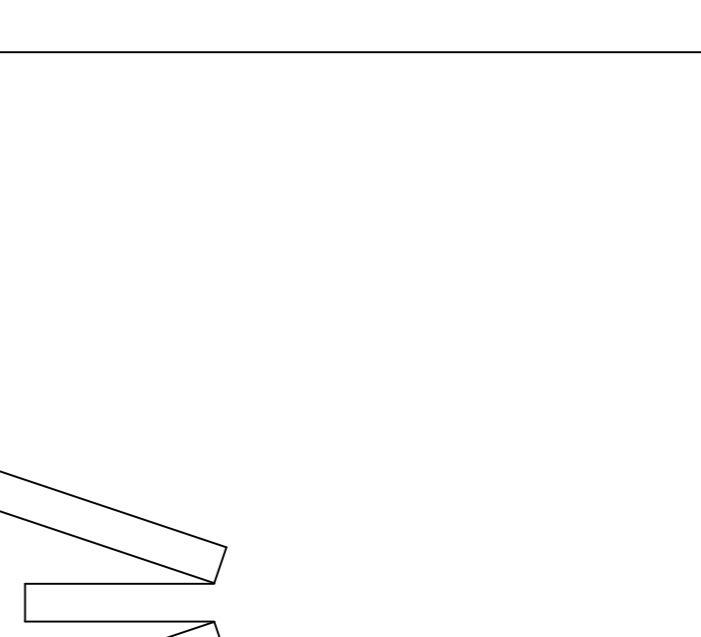
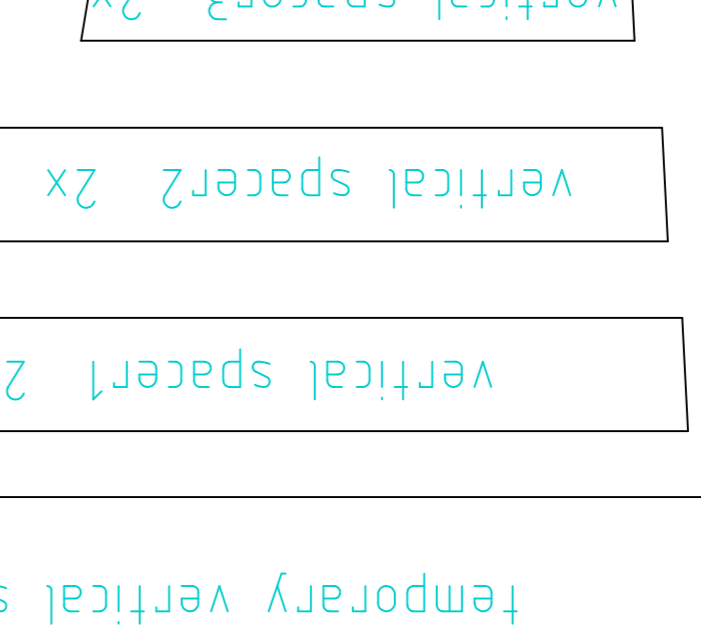
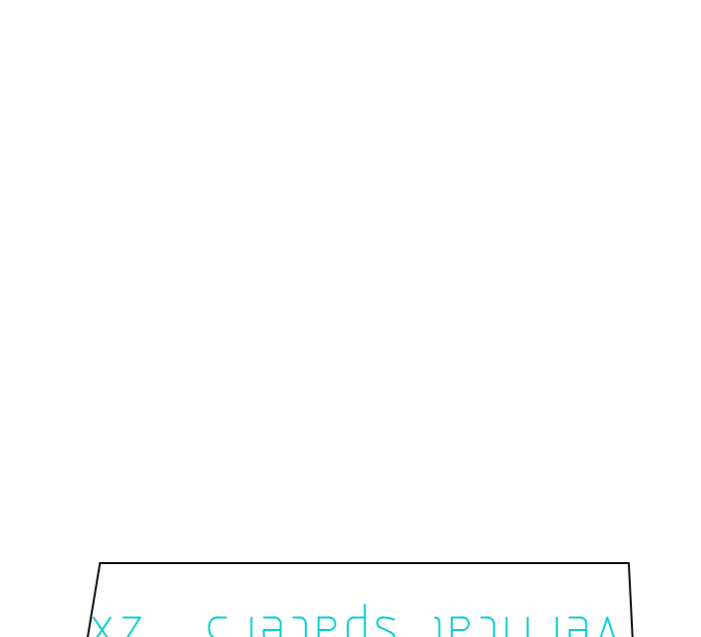
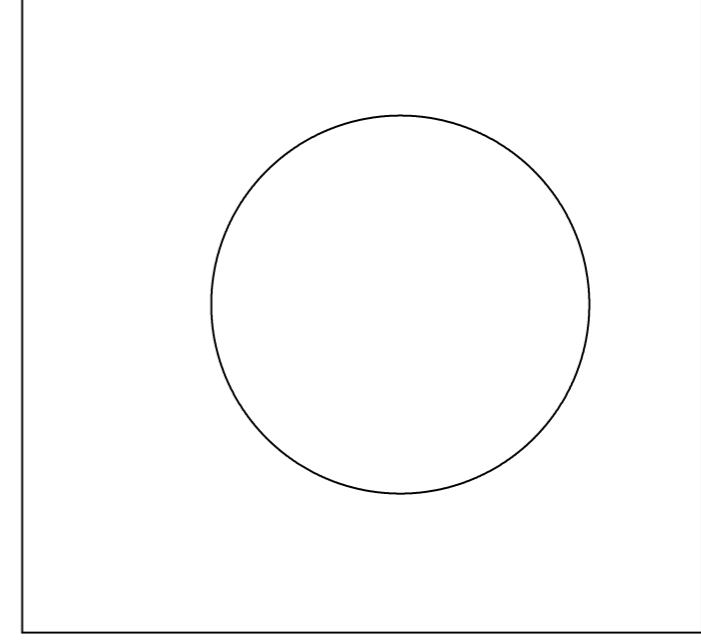
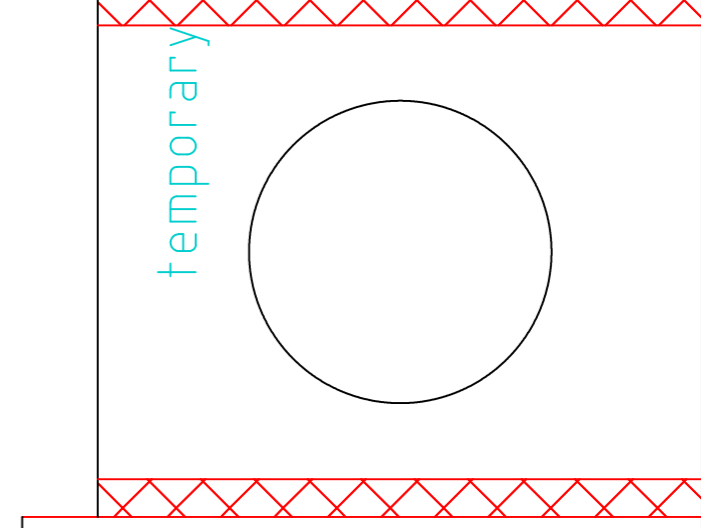
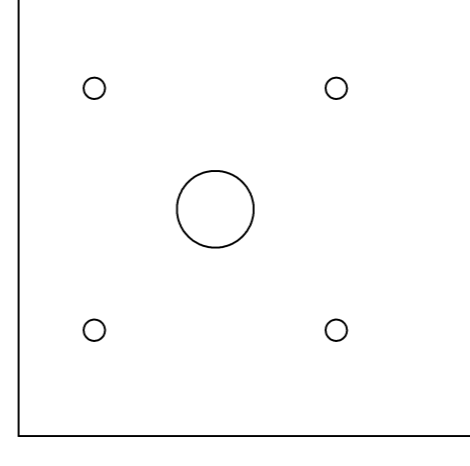

B-Fold

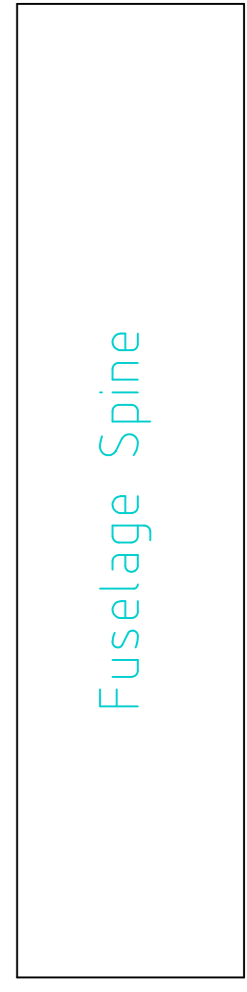
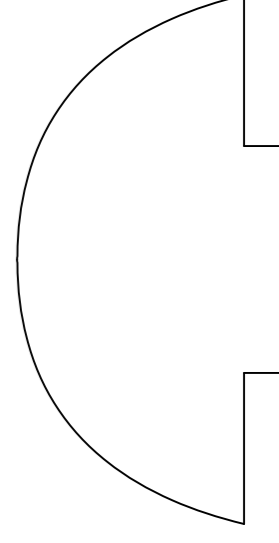
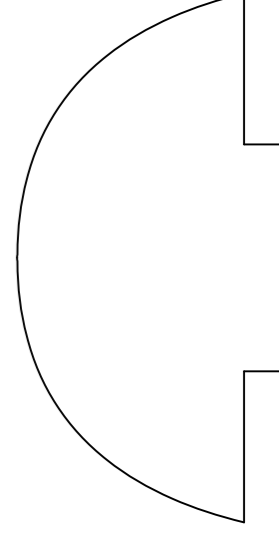

Fuselage Spine

1 234 567 891 0

black = cut  
 red = score 50%  
 blue = lightly crease  
 light blue = information

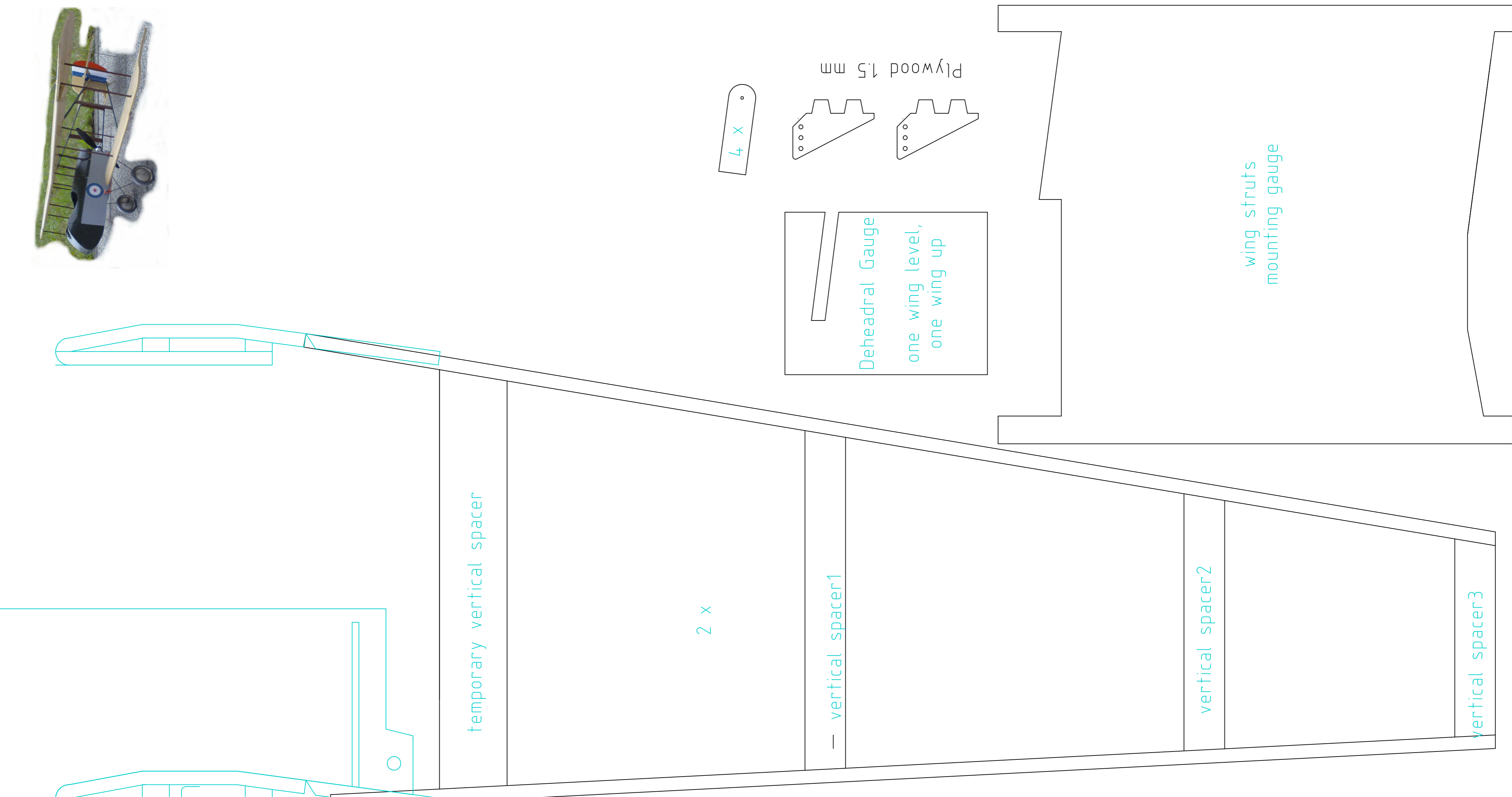
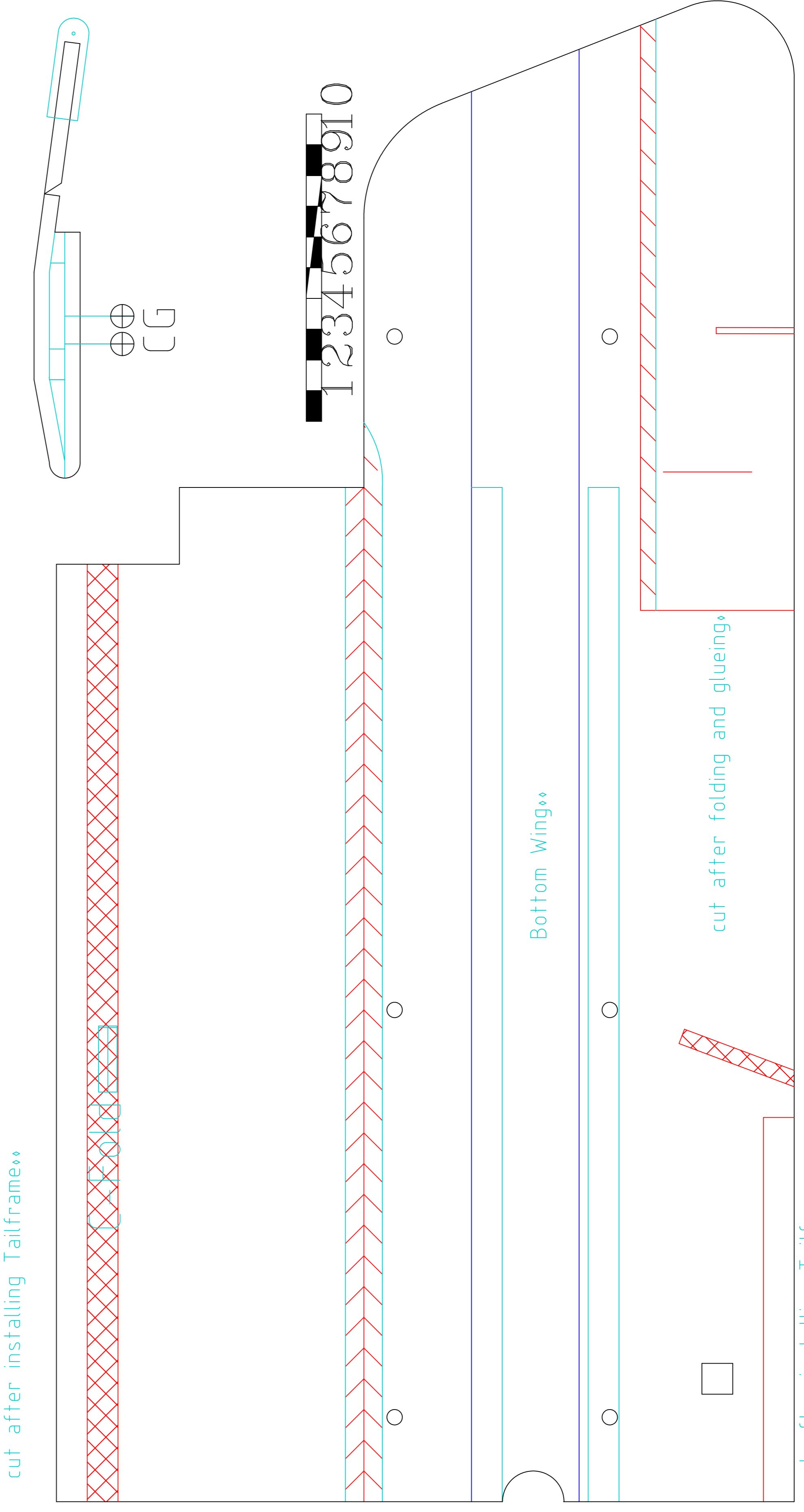
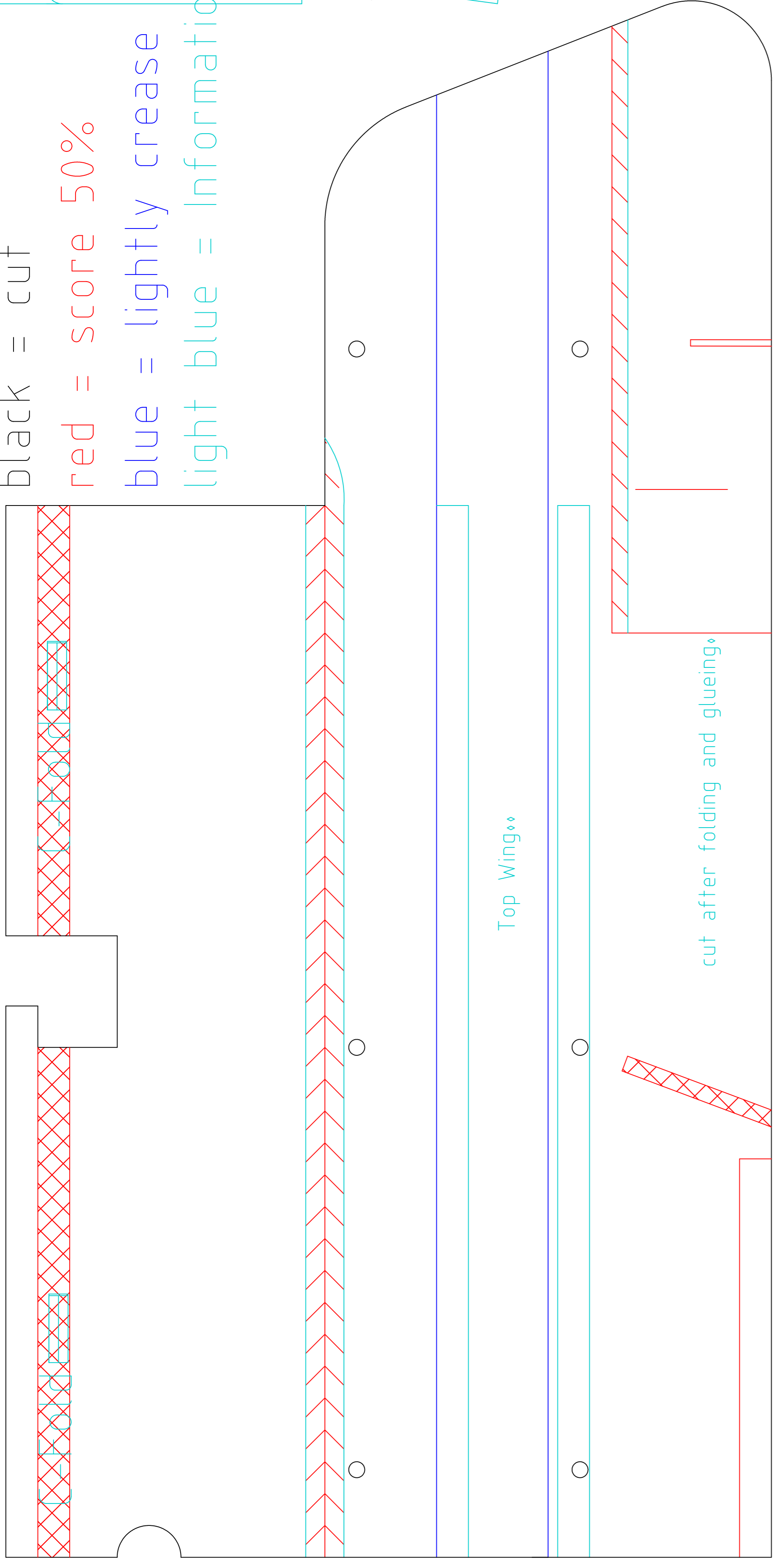

12345678910

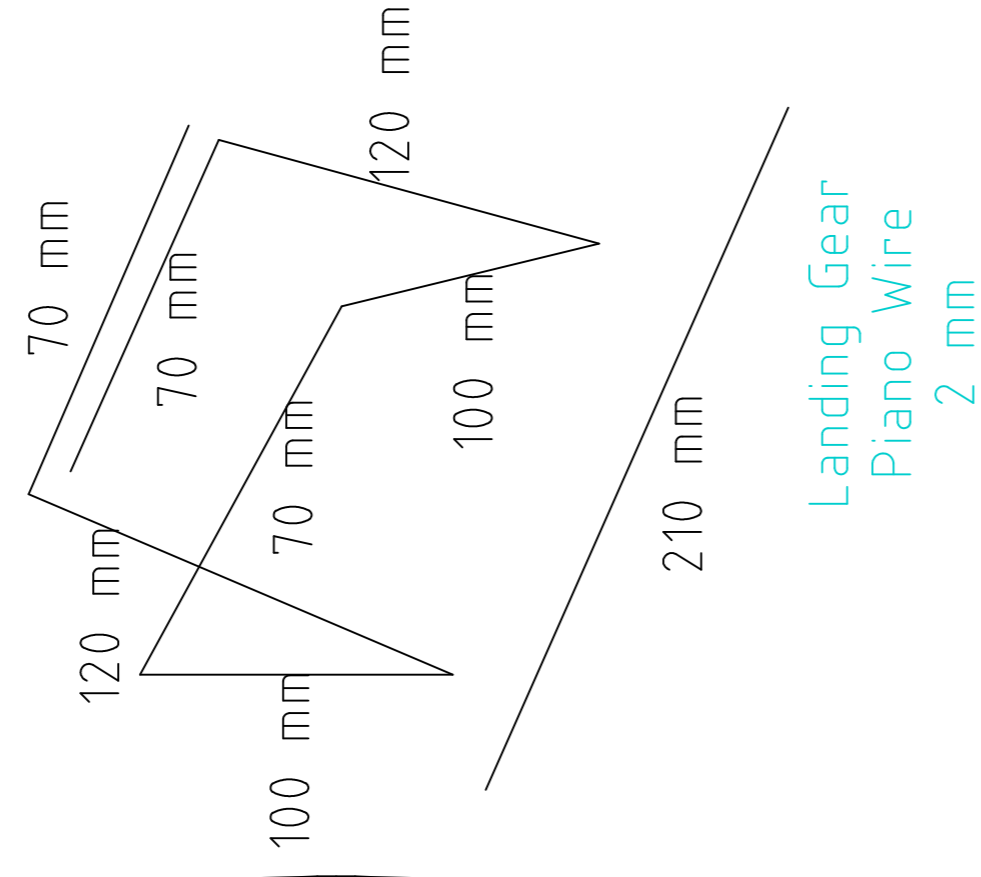
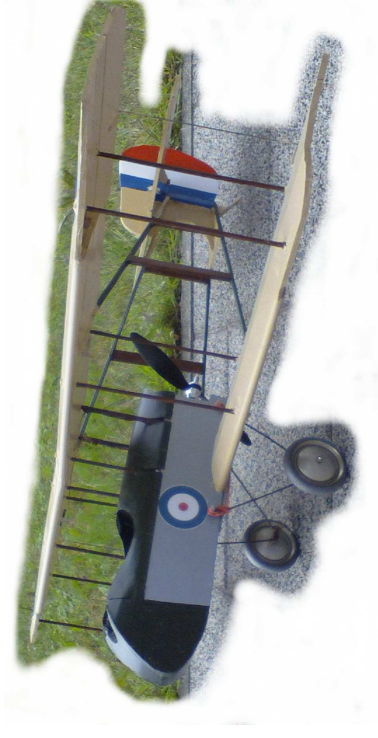

Landing Gear Piano Wire 2 mm

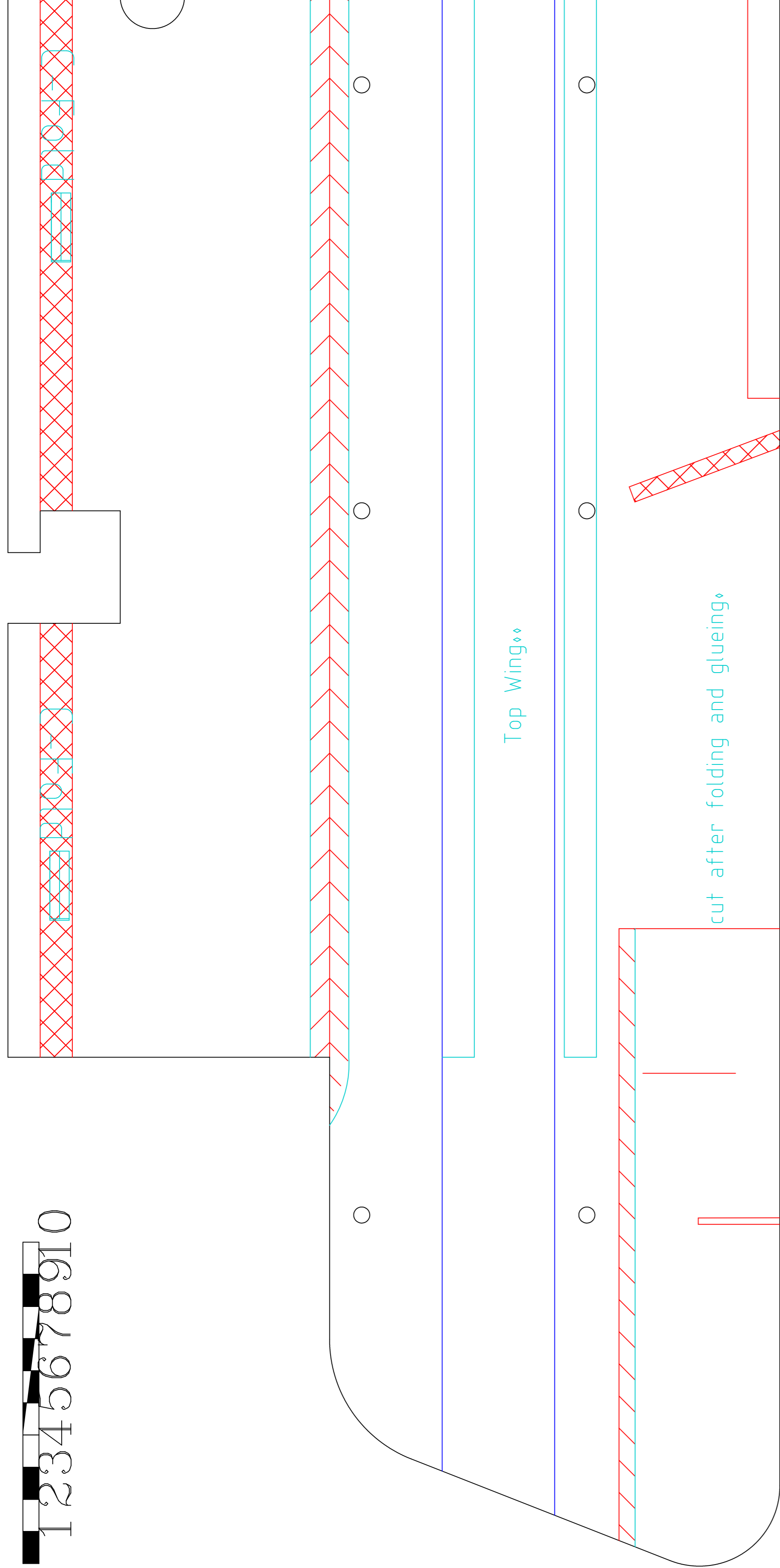
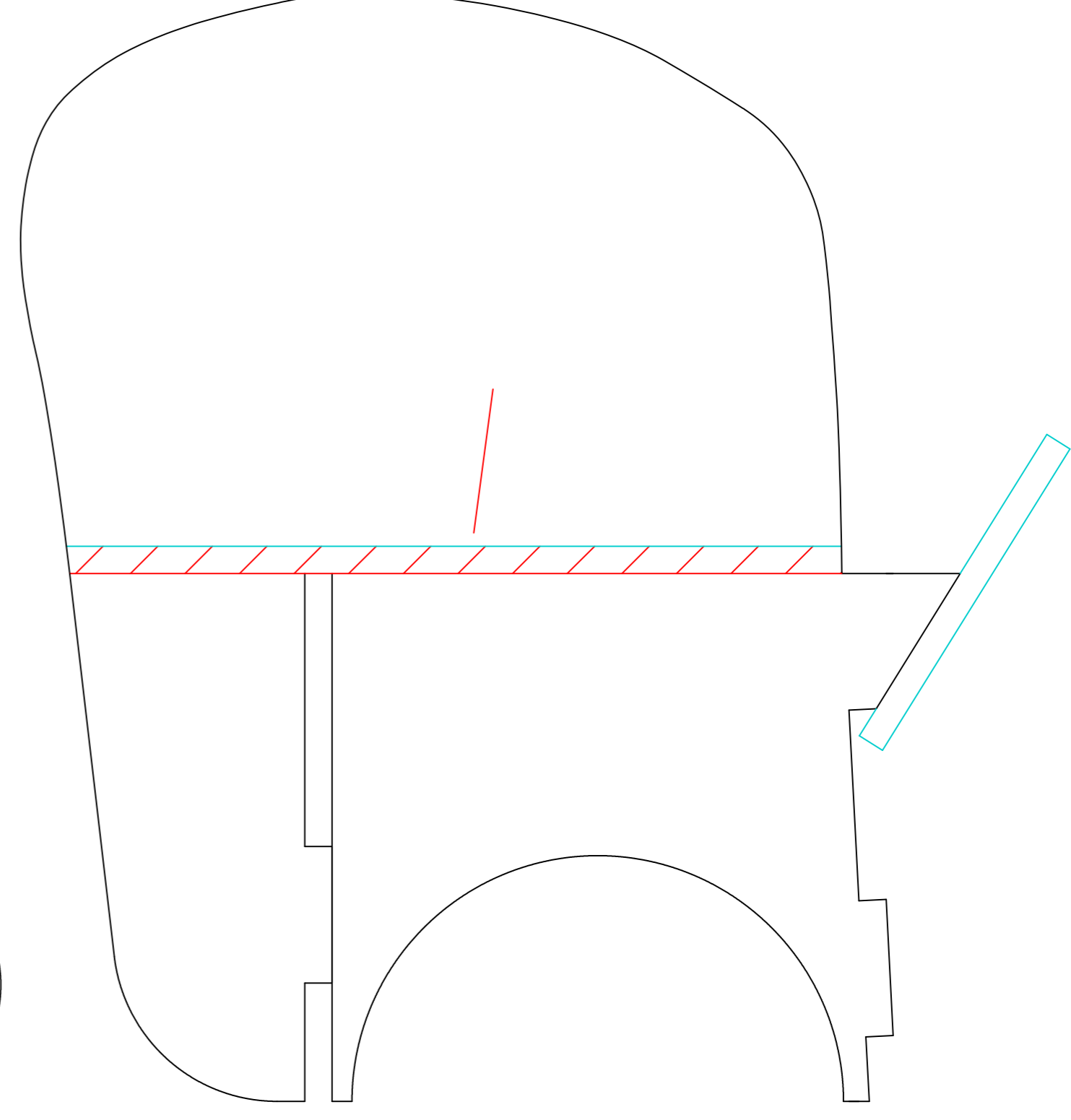
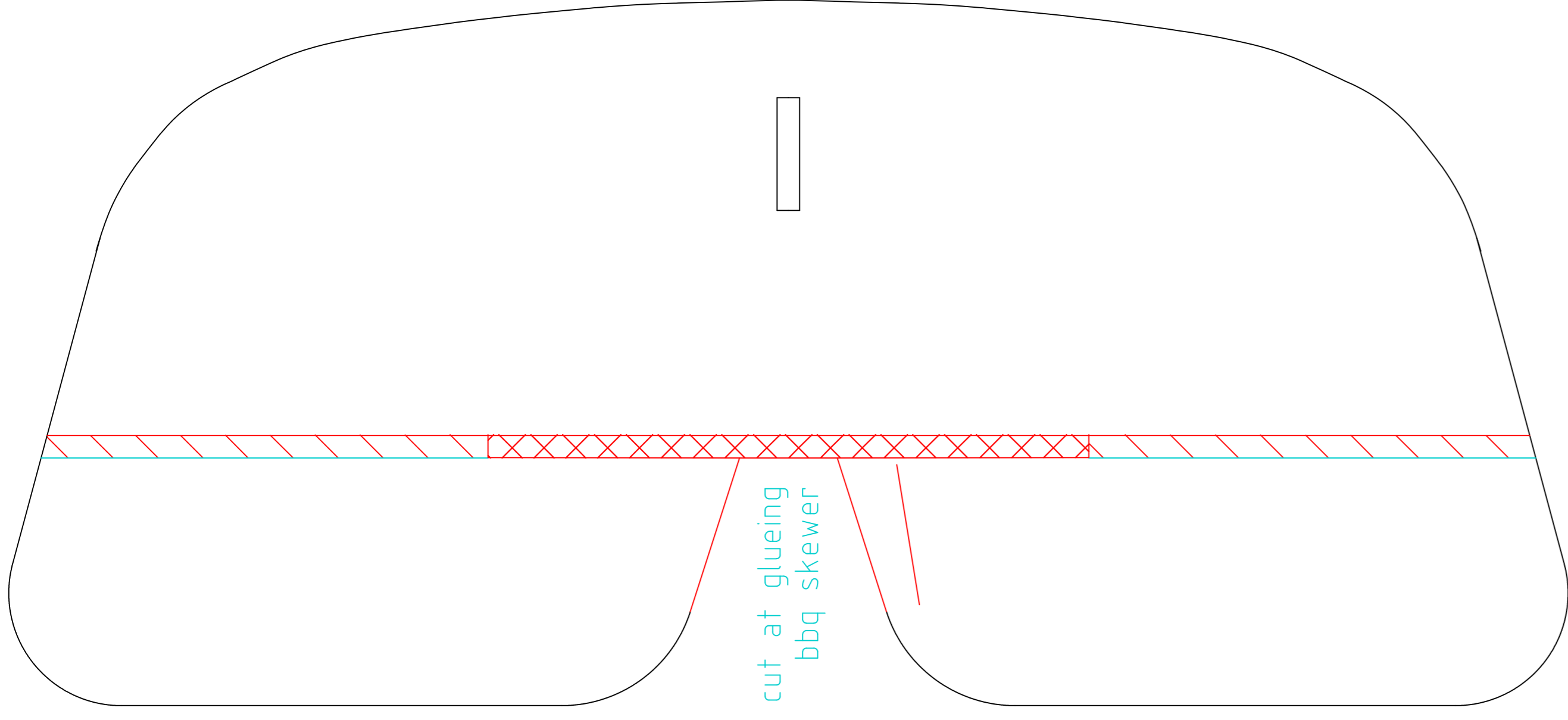
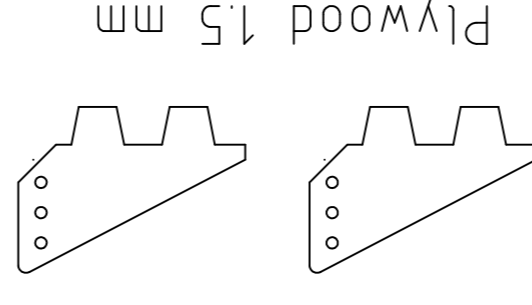

Top Wing\*\*

cut after folding and glueing\*

cut after installing Tailframe\*\*

black = cut

red = score 50%

blue = lightly crease

light blue = Information

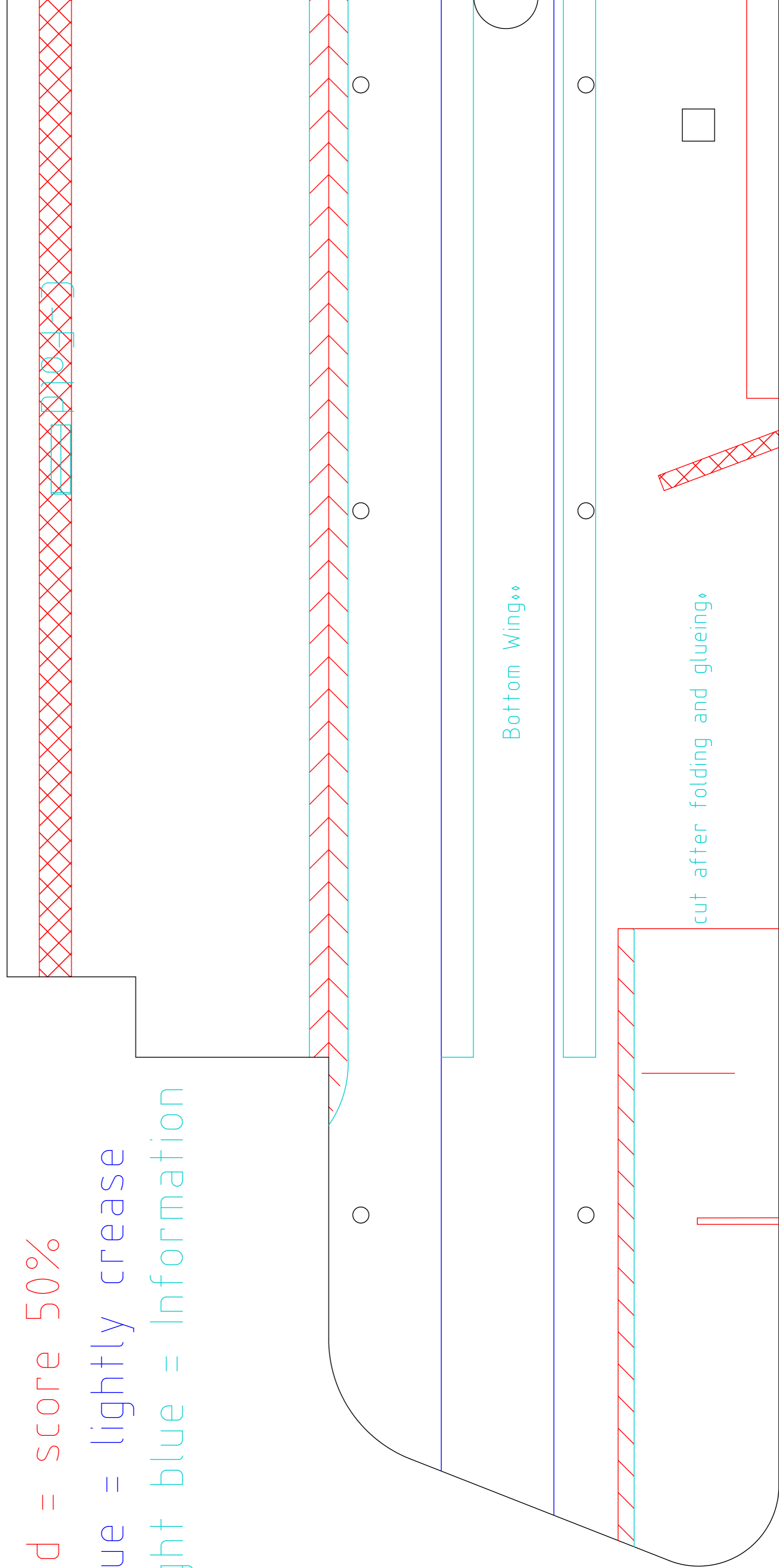

Bottom Wing\*\*

cut after folding and glueing\*

cut after installing Tailframe\*\*

FB Kite by Werner Klotsche 2017