

1" x 6"

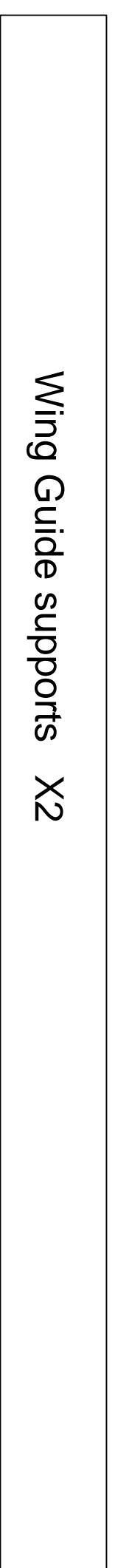

Wing Guide supports X2

PT-17 Stearman By: Tim Kelley

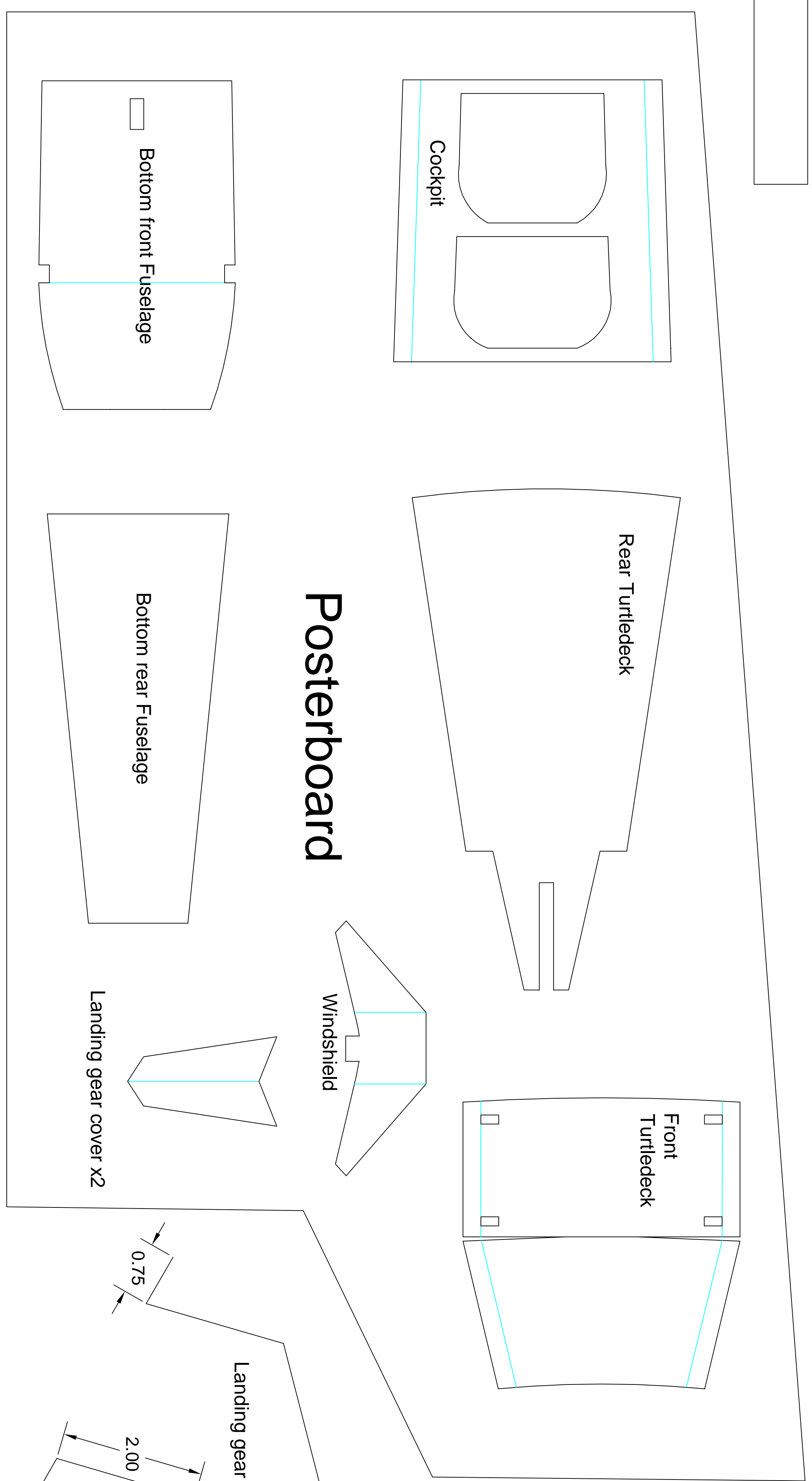
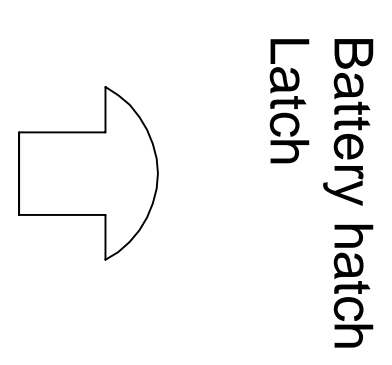
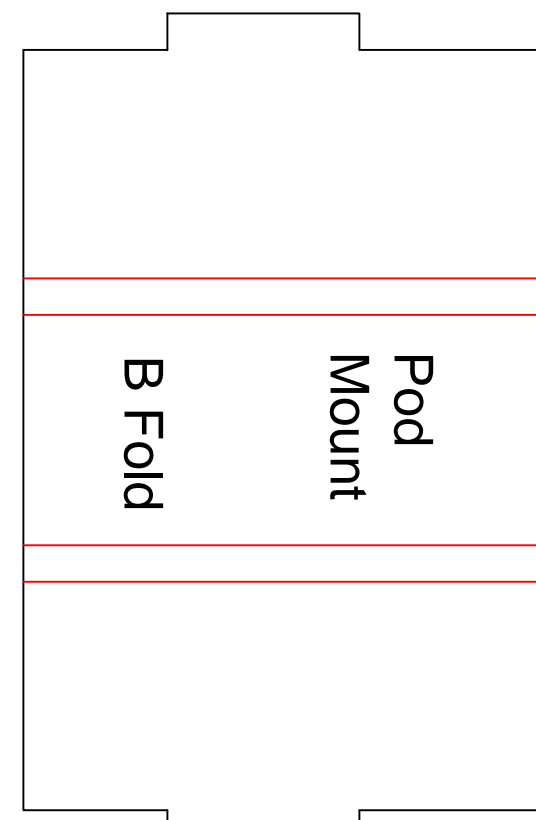
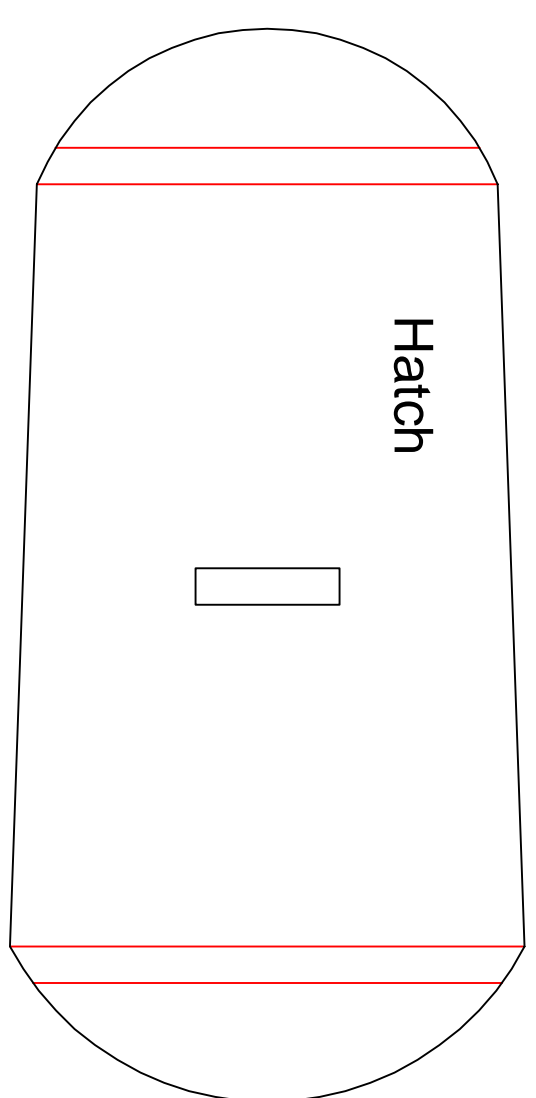
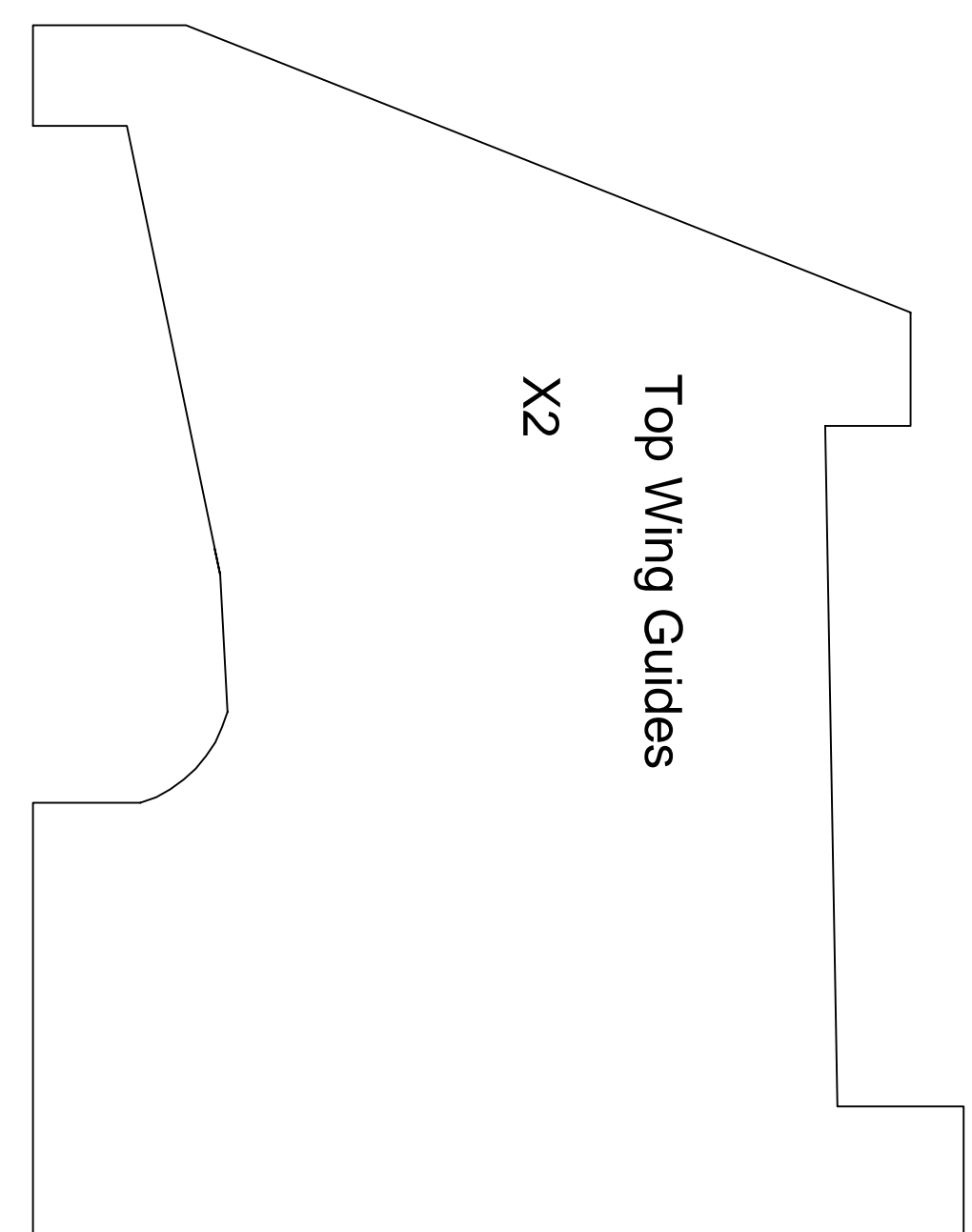
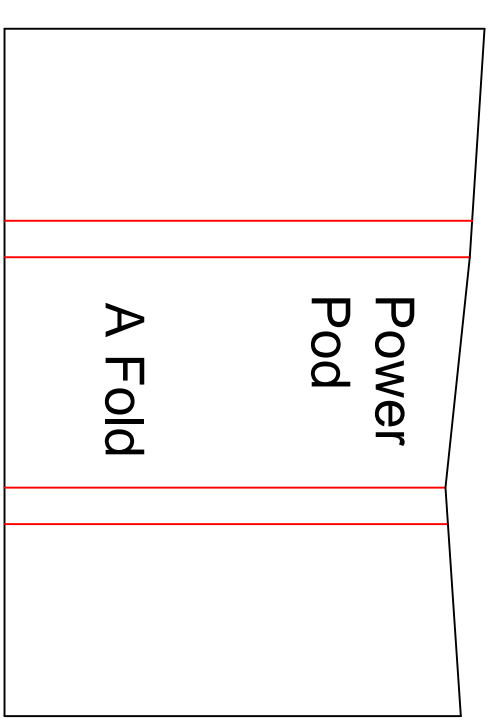

Posterboard

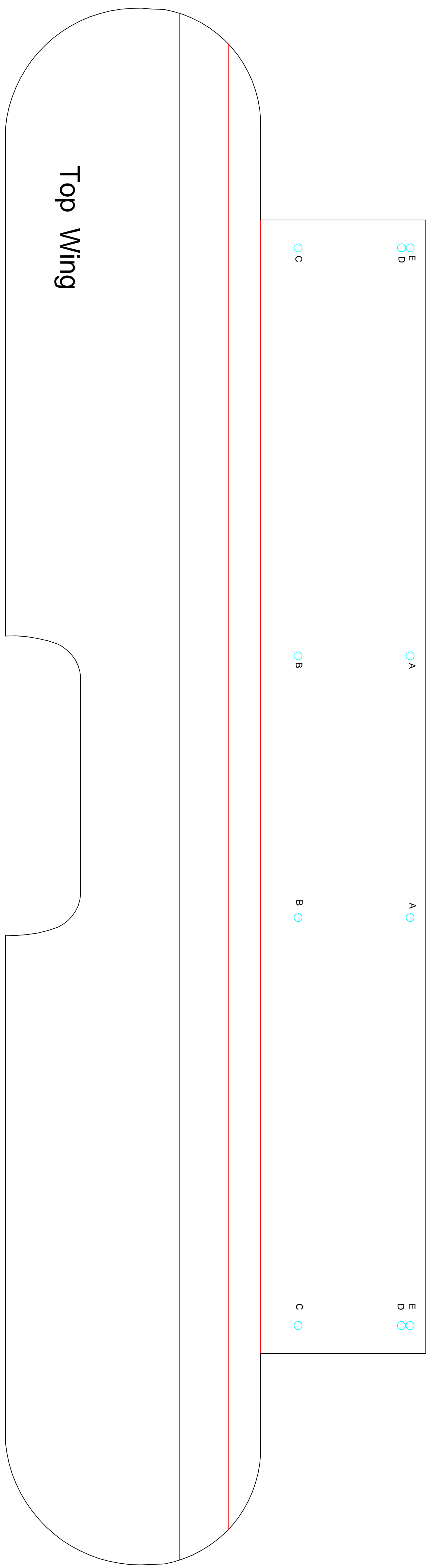
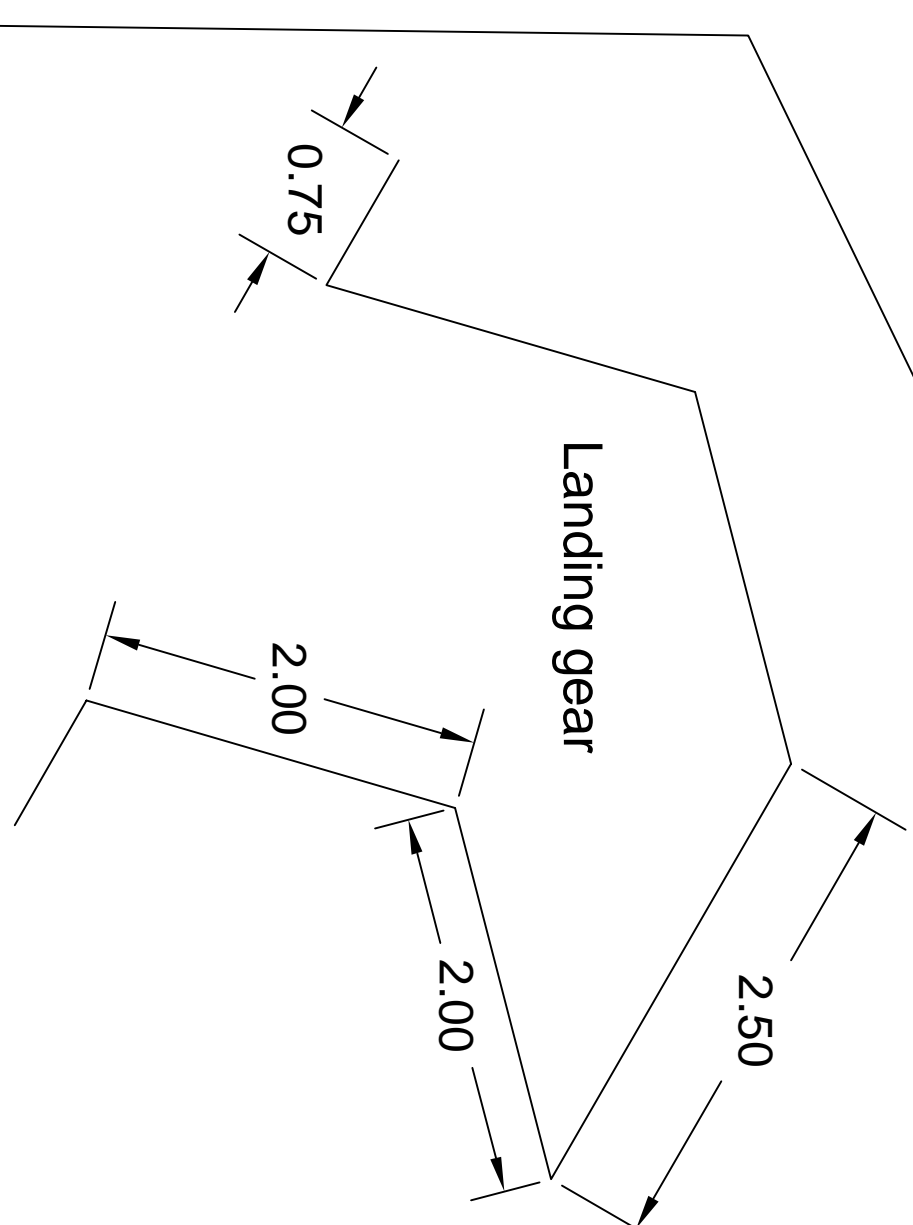

Top Wing

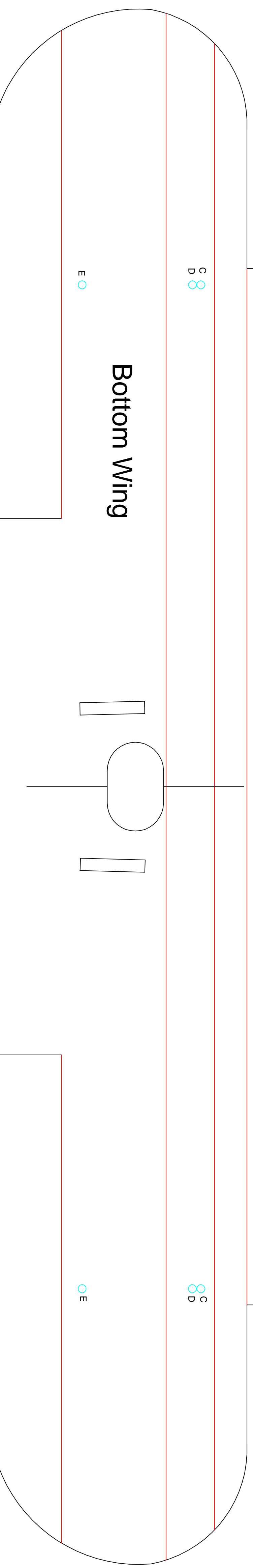

Bottom Wing

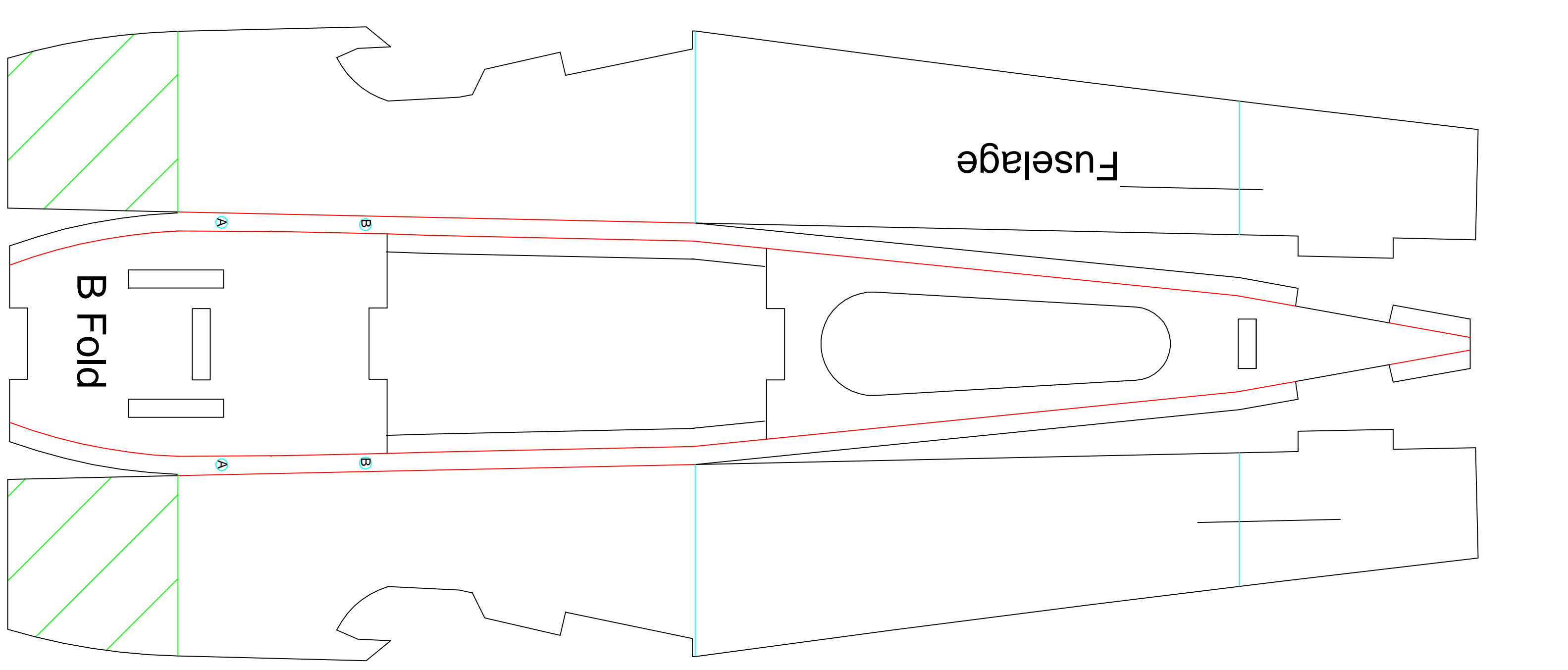
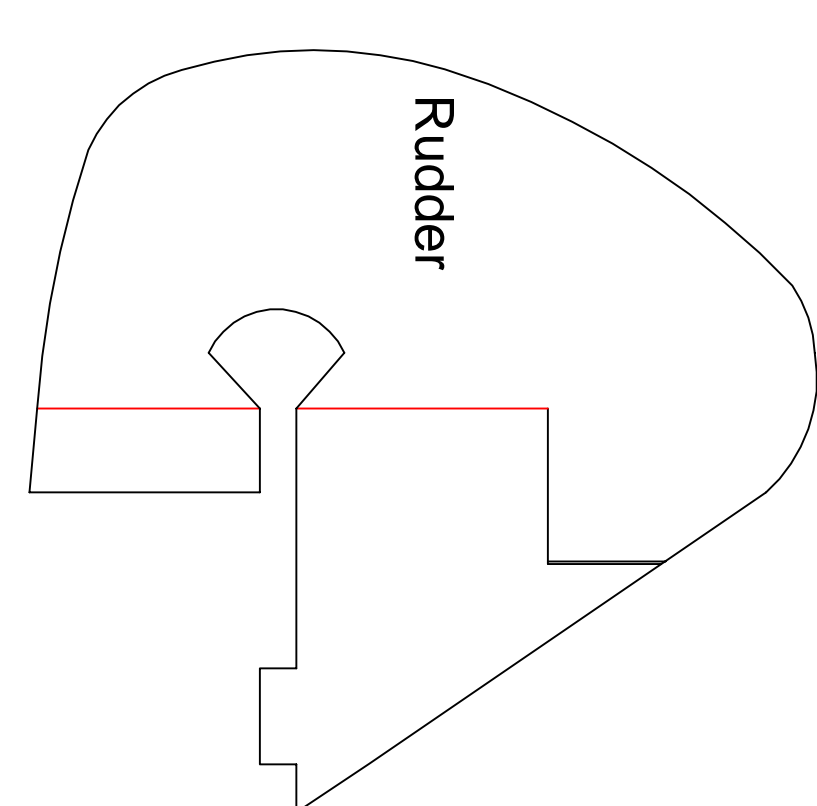
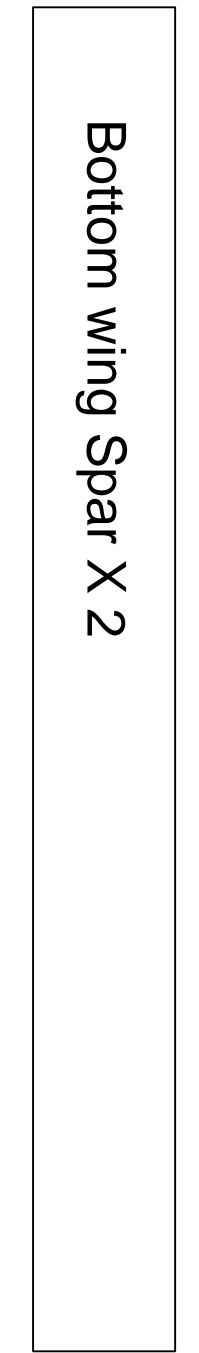

Fuselage

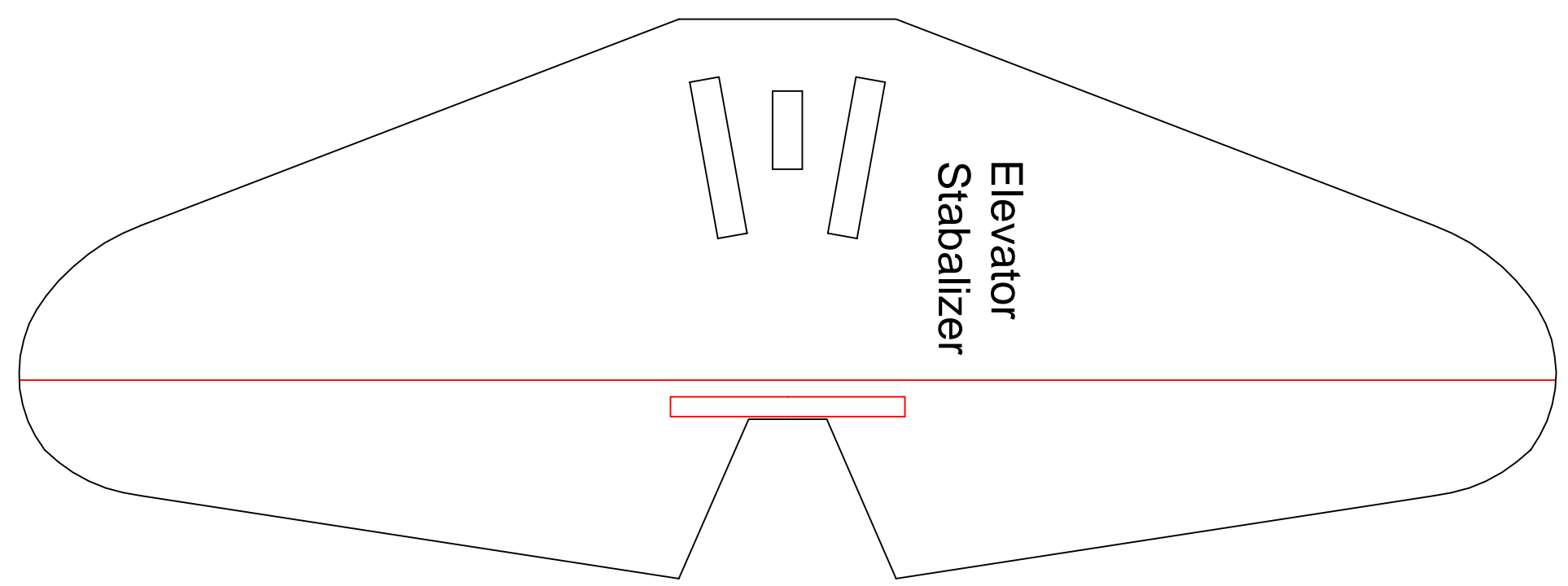

Elevator Stabilizer

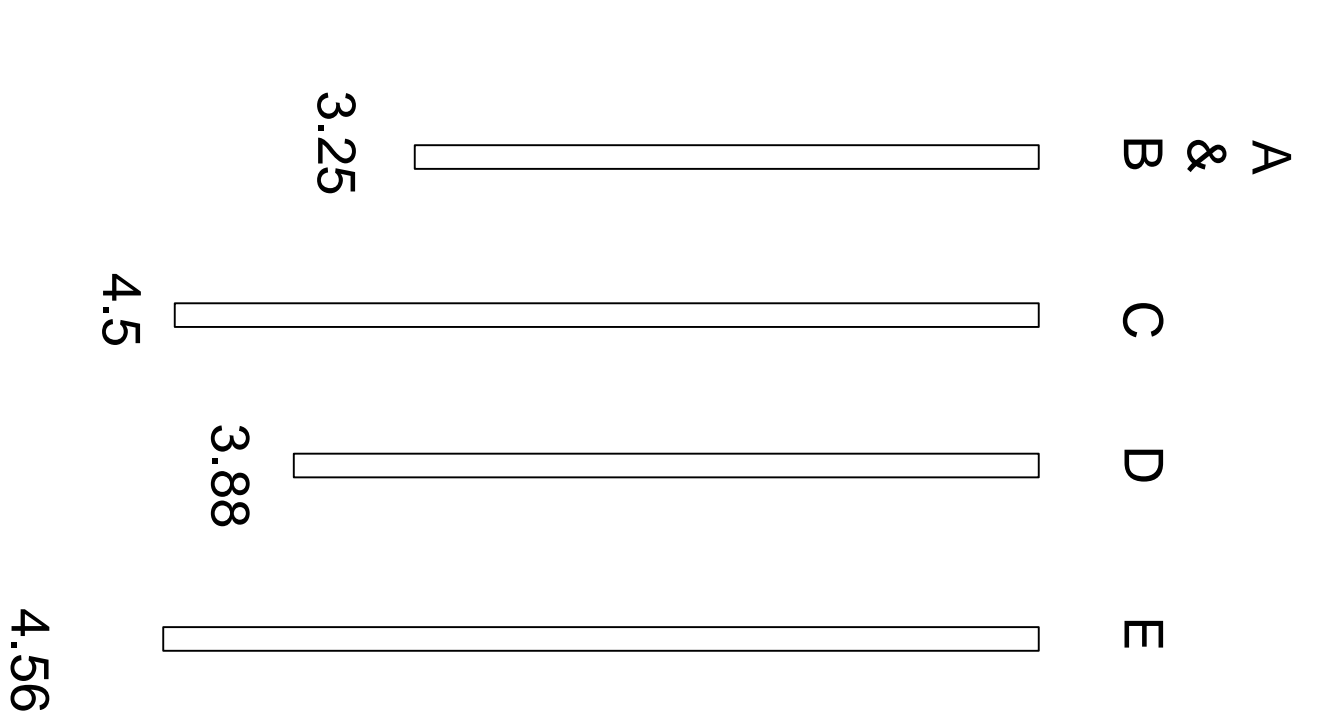

Wing struts (2 each)

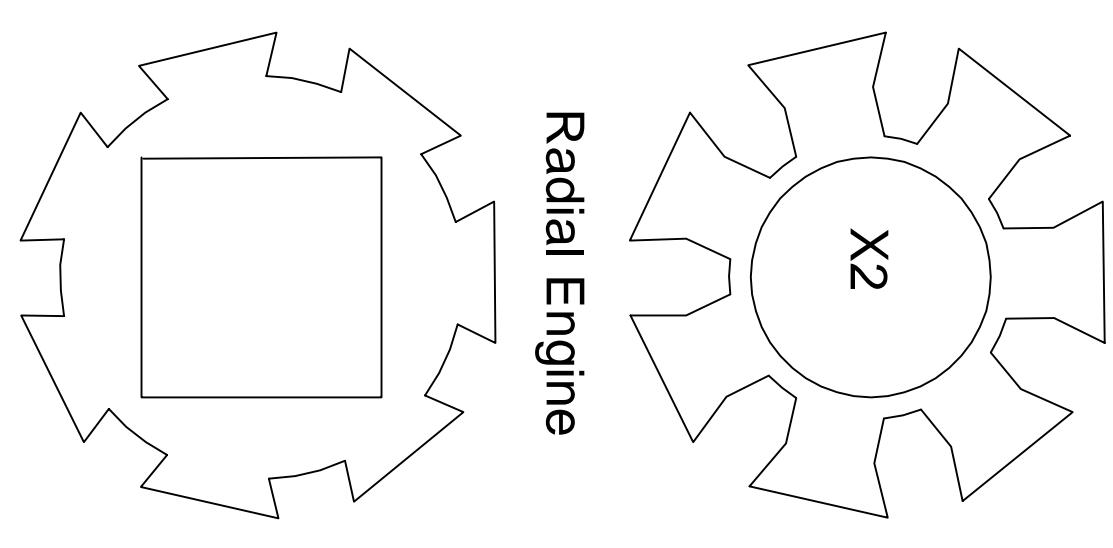

Radial Engine

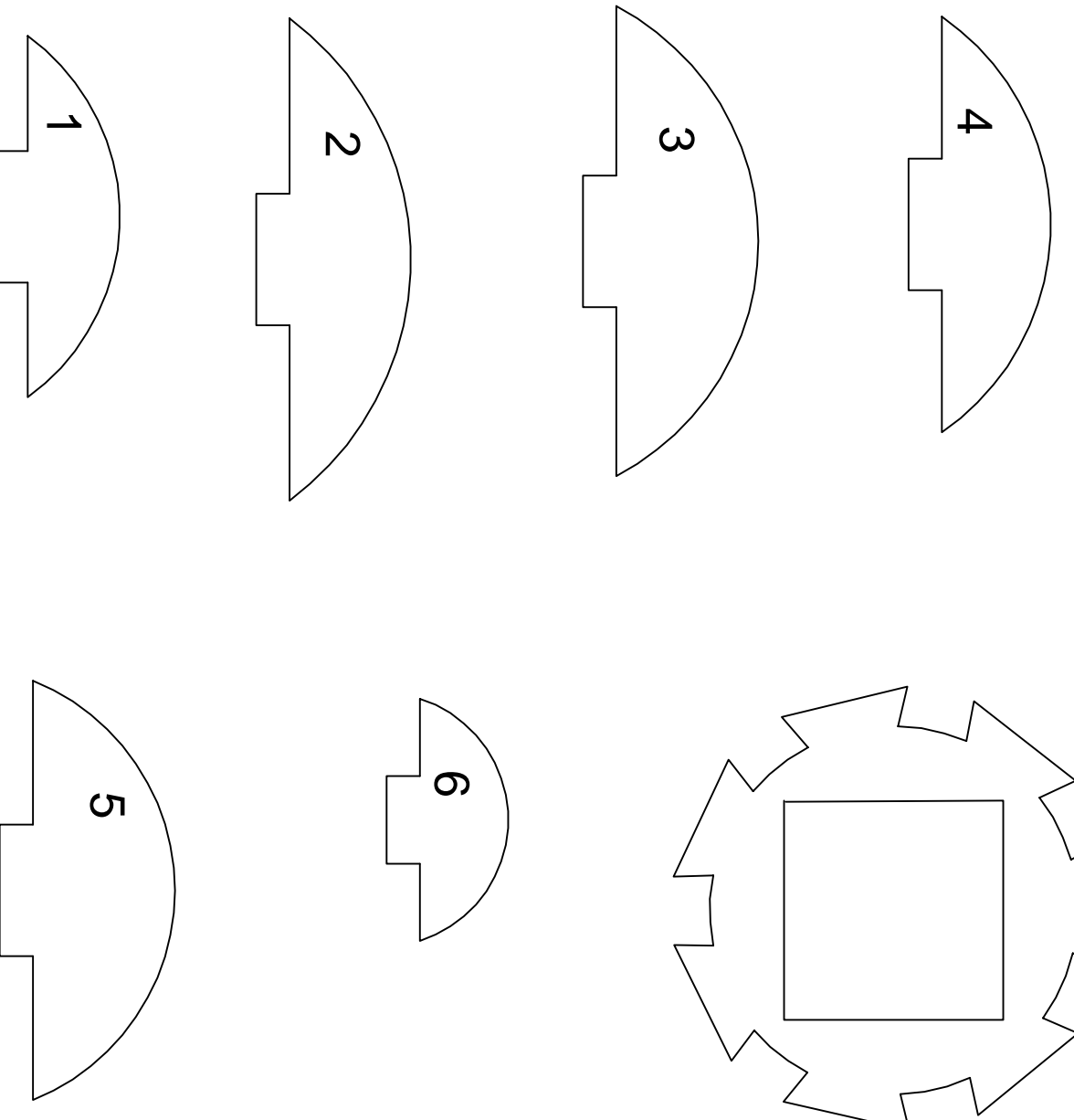

Do not fold aileron hinges till after both wings are assembled on aircraft.