

original Free plans  
Plans copied and m

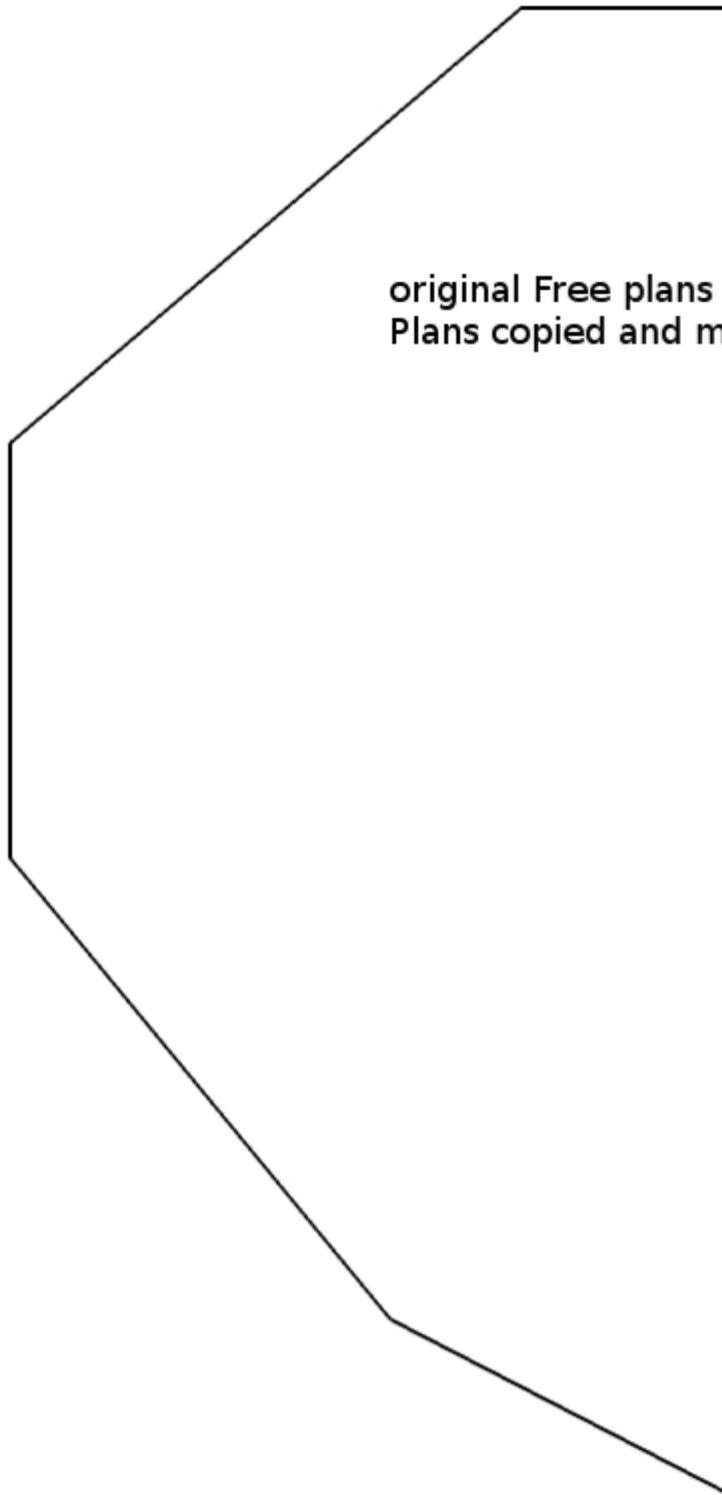

ns by [www.Flitetest.com](http://www.Flitetest.com)  
d modified by Steve Yuktonis

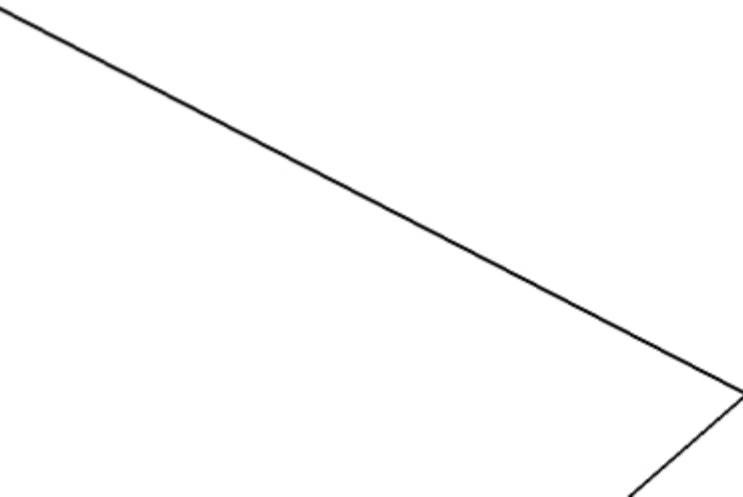

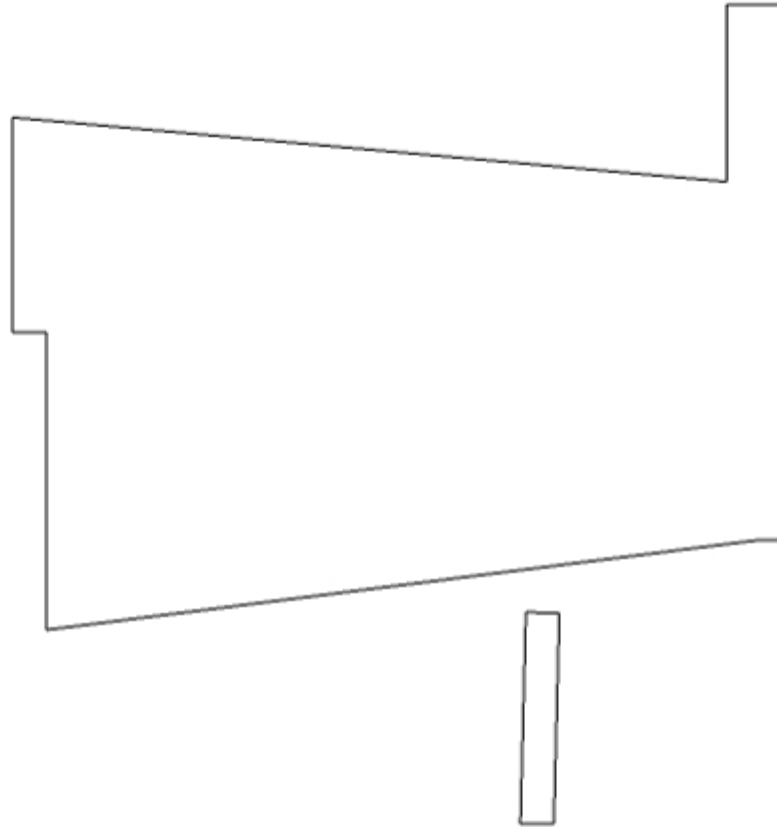
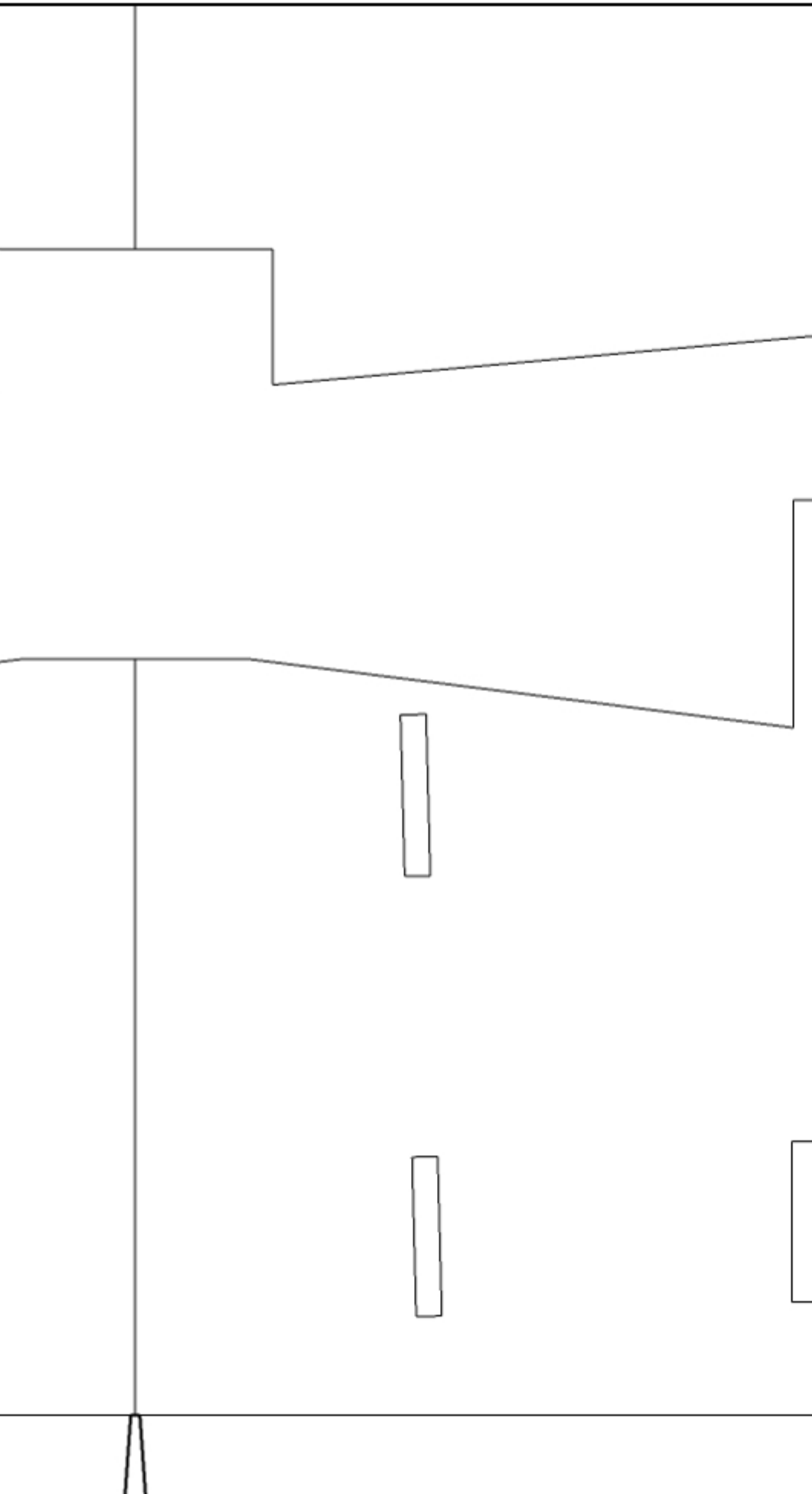

set up for 2212-? 1000 to 2200  
style motor on flitetest simp

If you use an ntm prop drive  
where the fire wall mounts  
fit correctly

props up to 8 inches

with a 70g motor plane will  
mah3s lipo

o 2200 kv motor or blue wonder  
mple firewall.

ive motor you may need to adjust  
ts or adjust the propslot to make it

will balance with 1300 to 2200

poster board





make 2

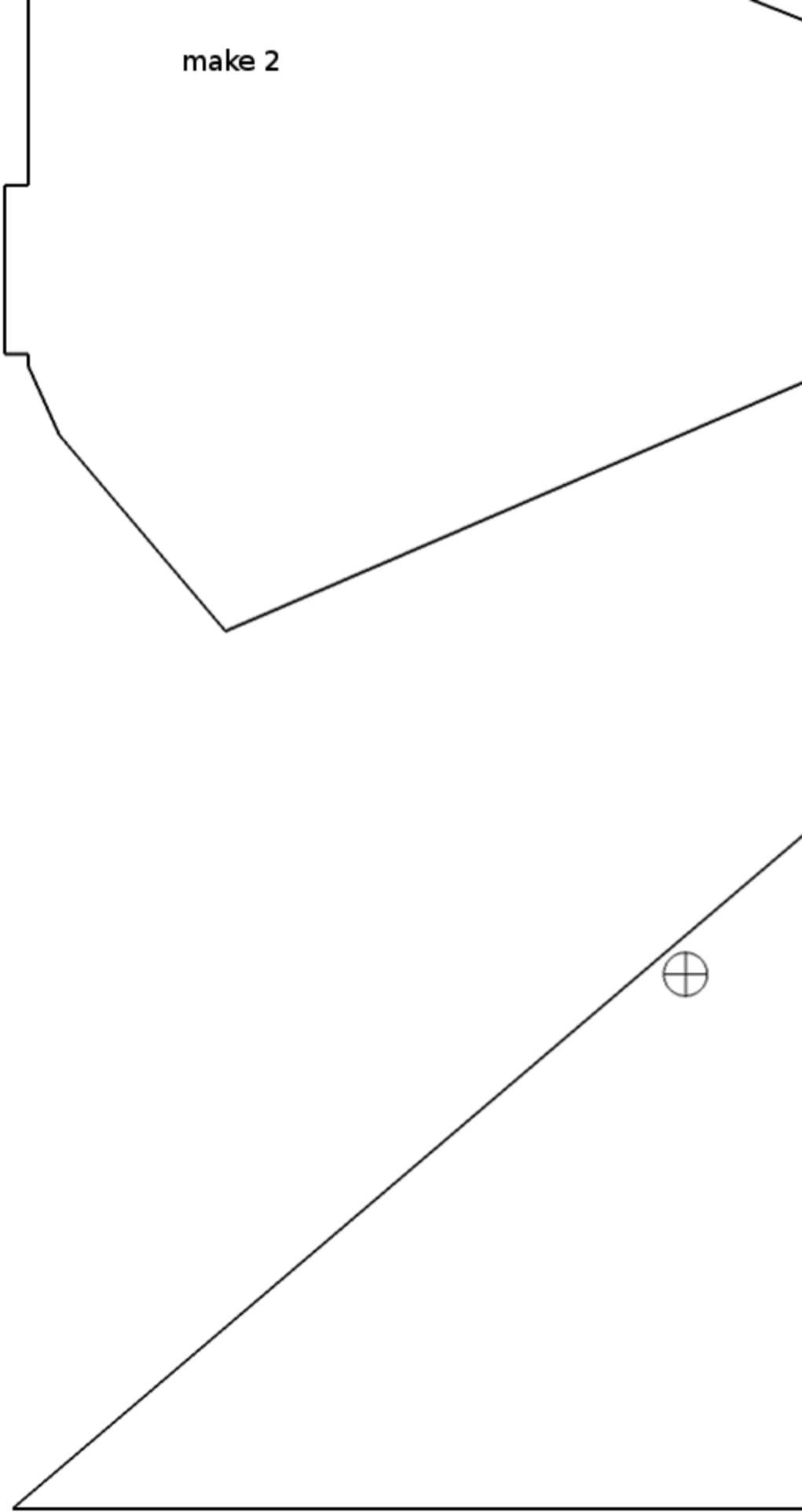

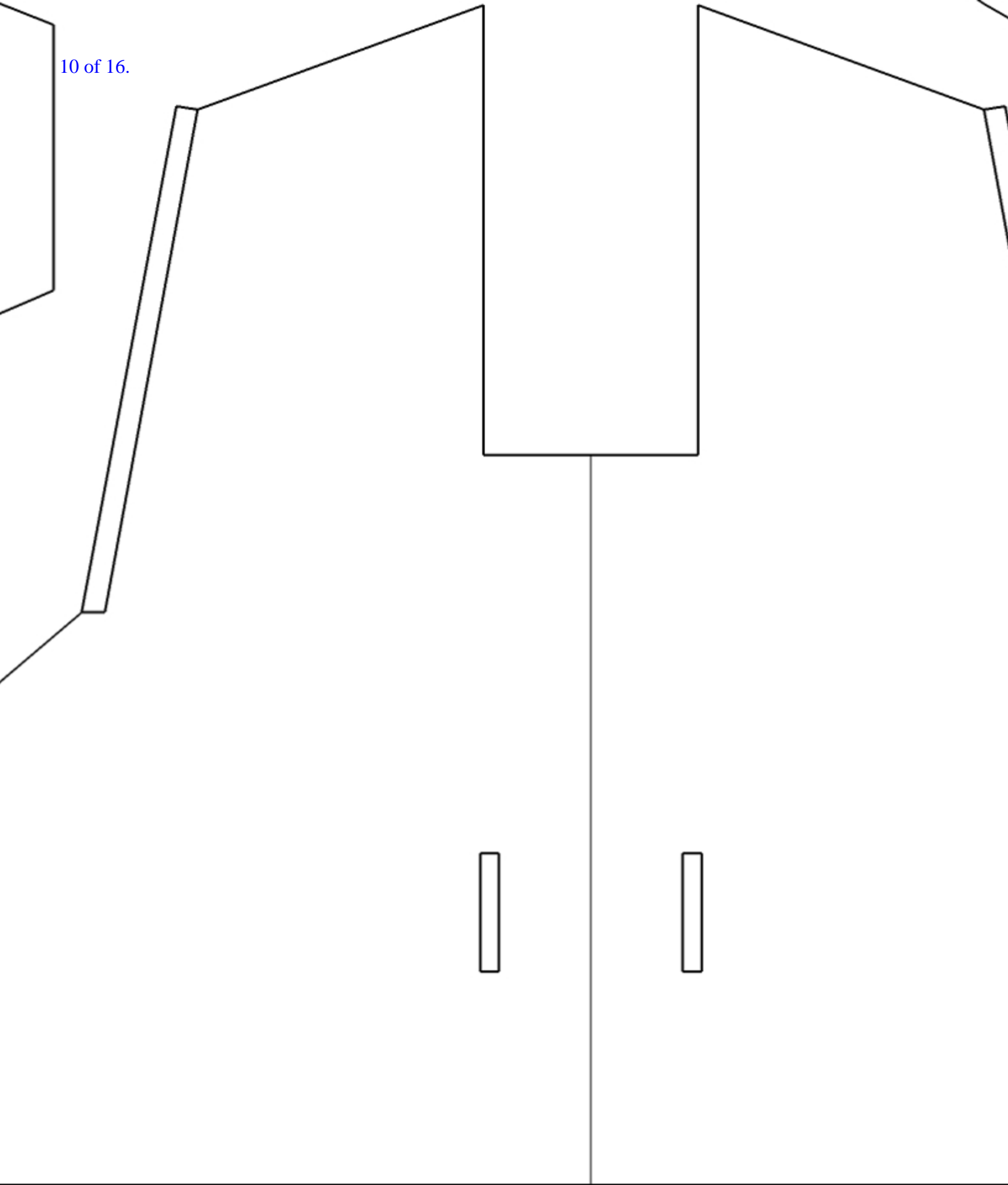

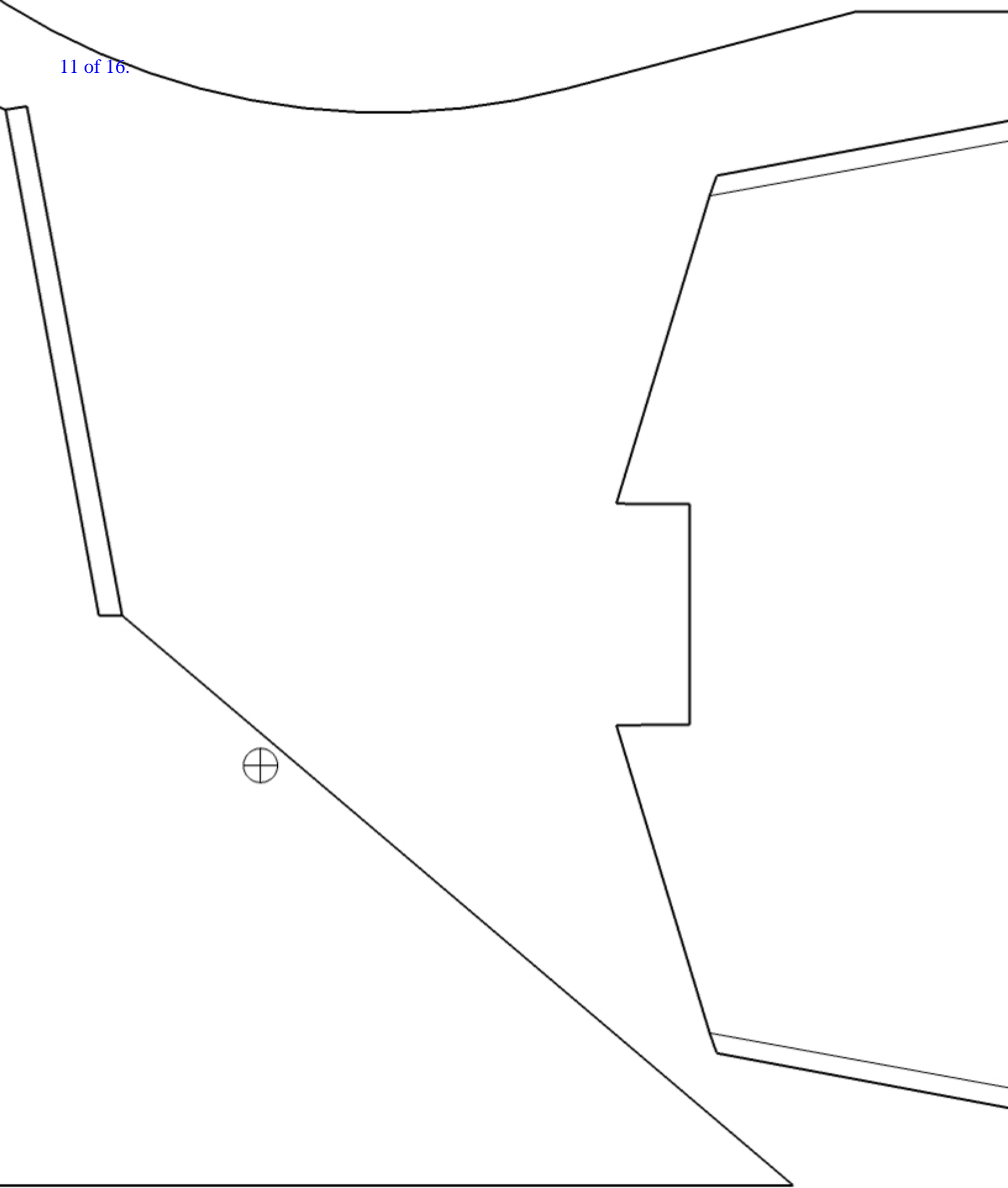



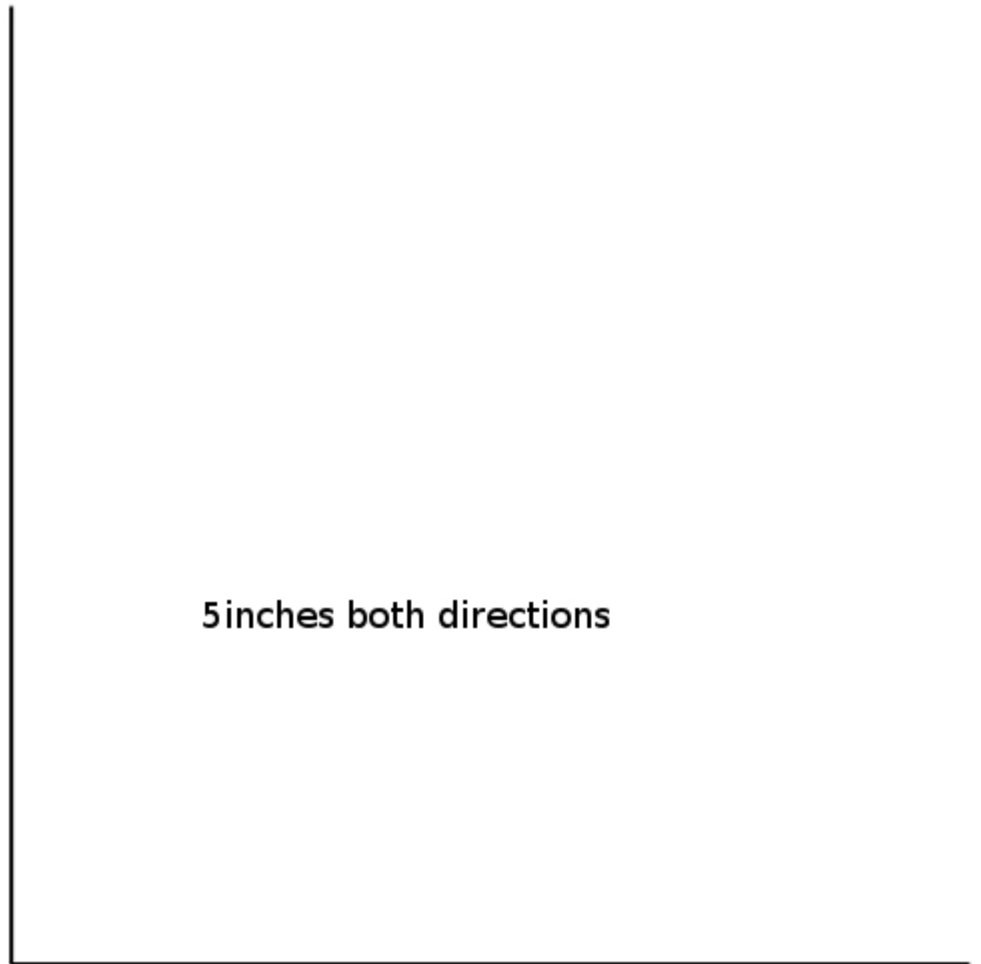

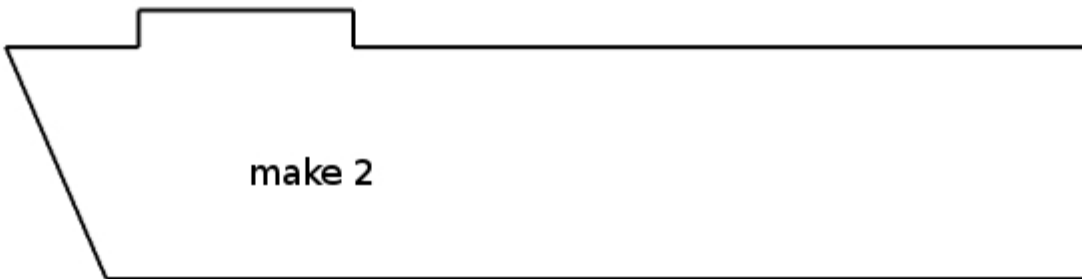
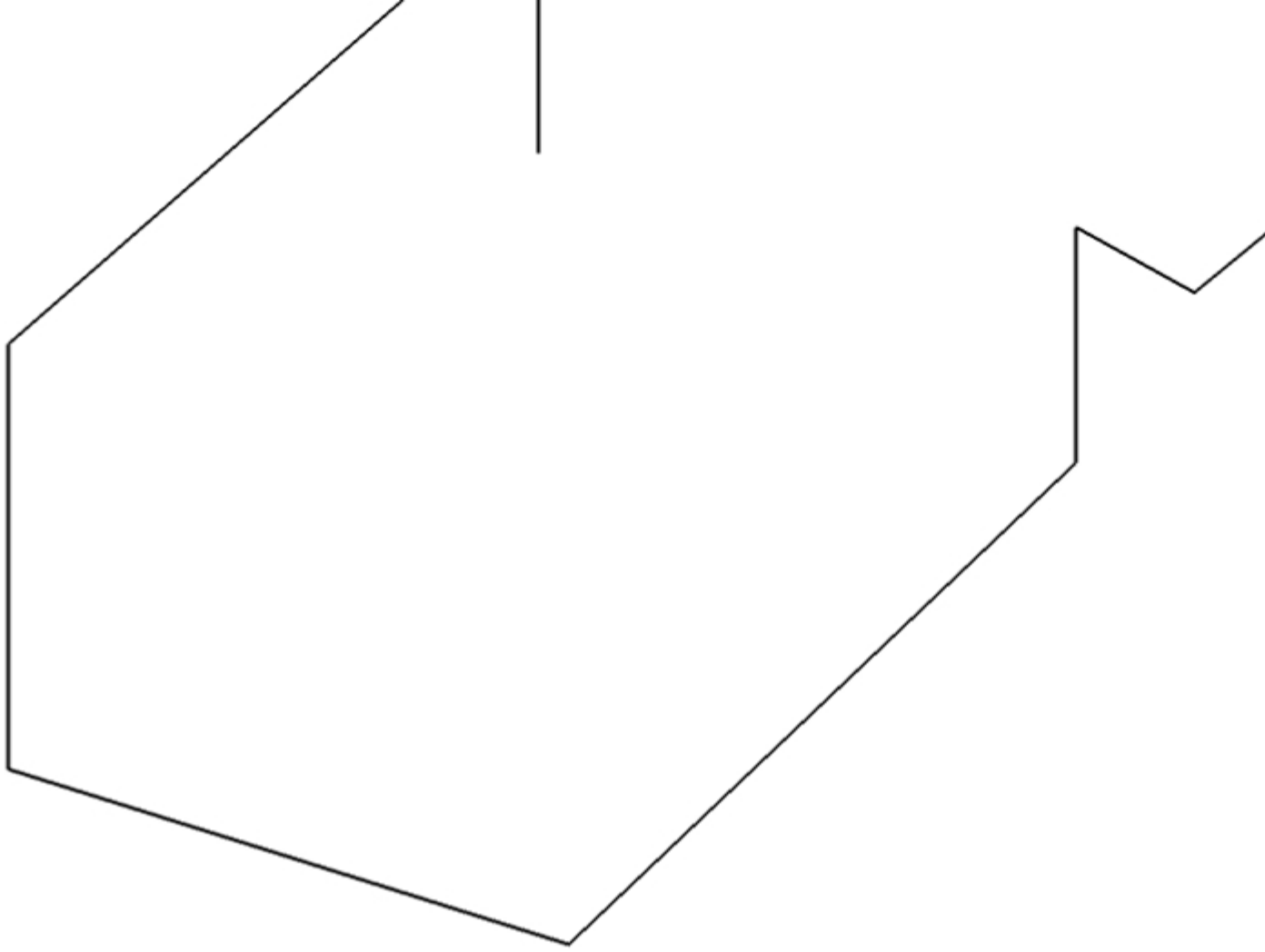

make 2

