

All parts 1.3# 9mm EPP F

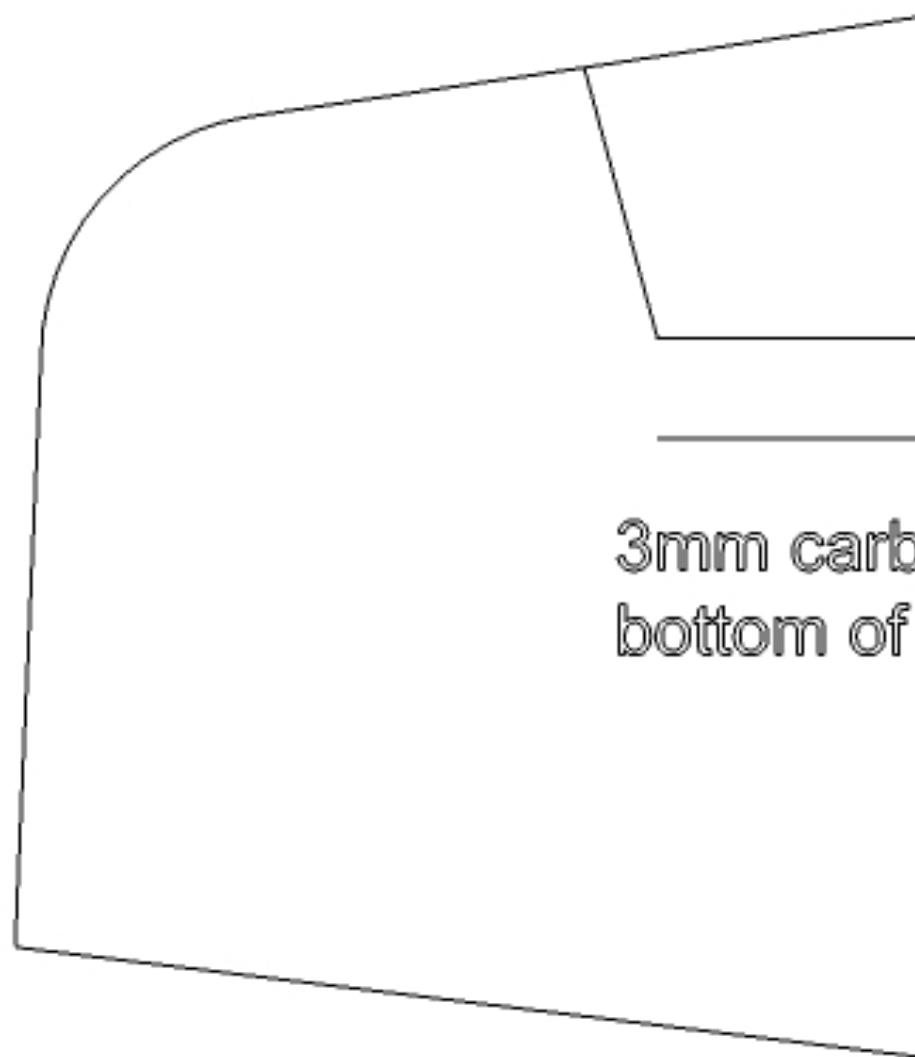

3mm carbon rod  
bottom of wing

oam

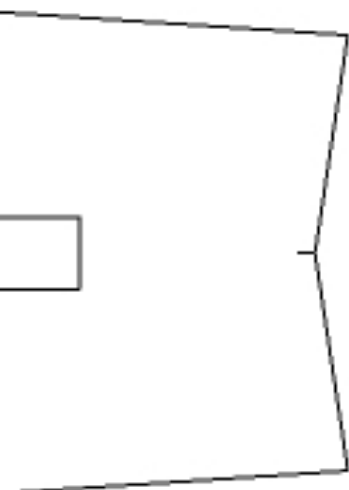

3mm carb  
bottom of



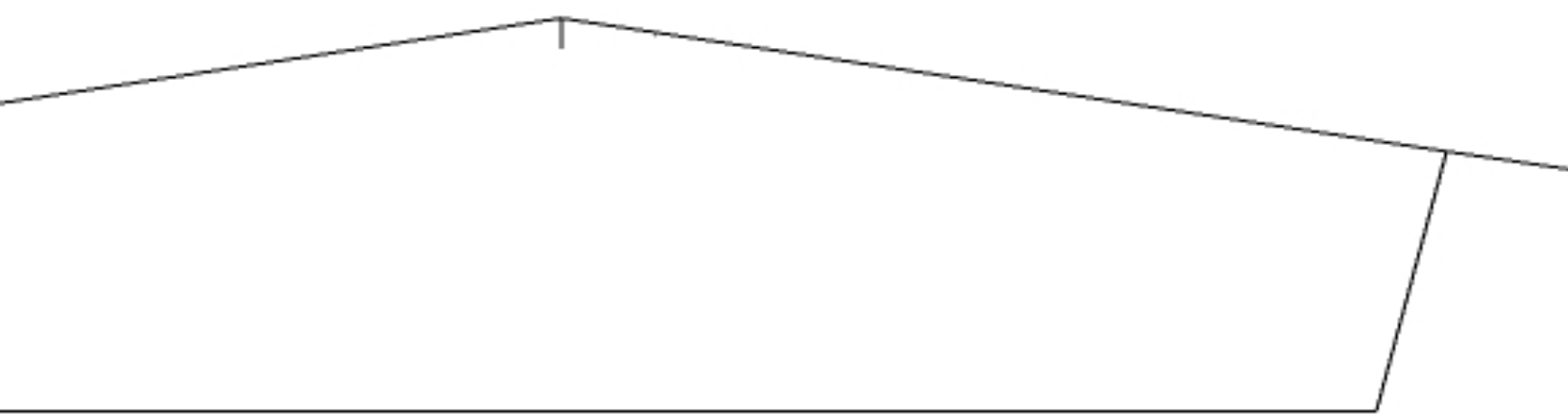

on rod  
elevator

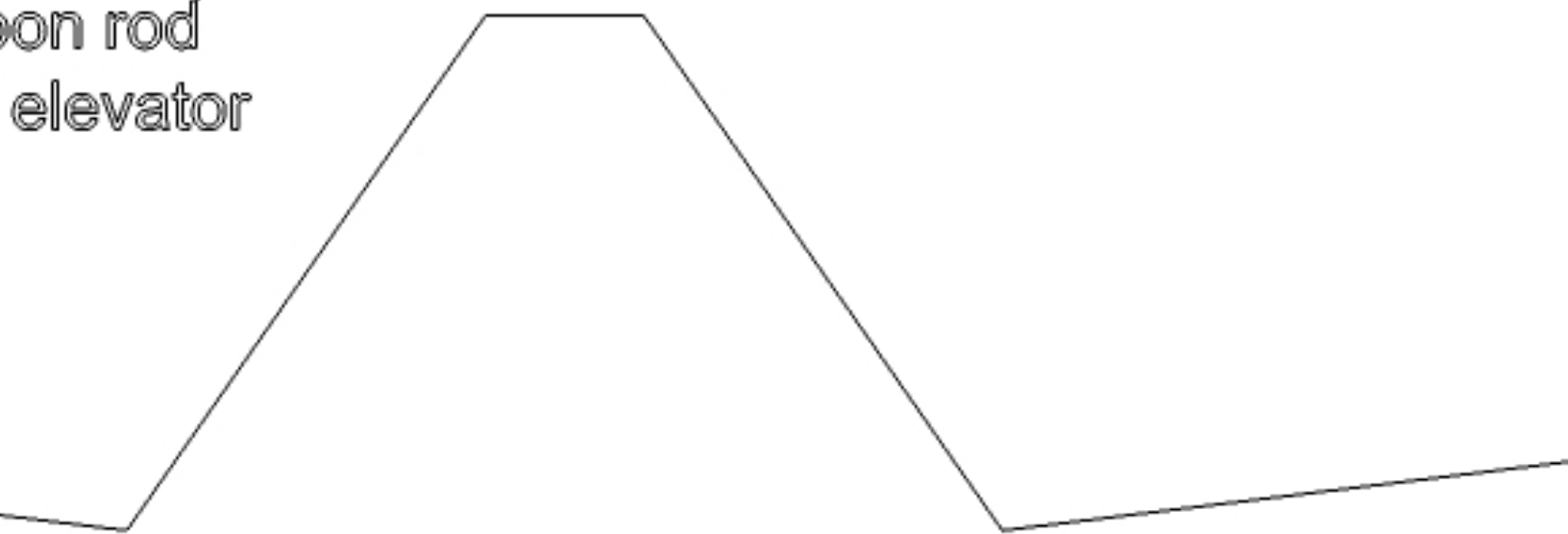

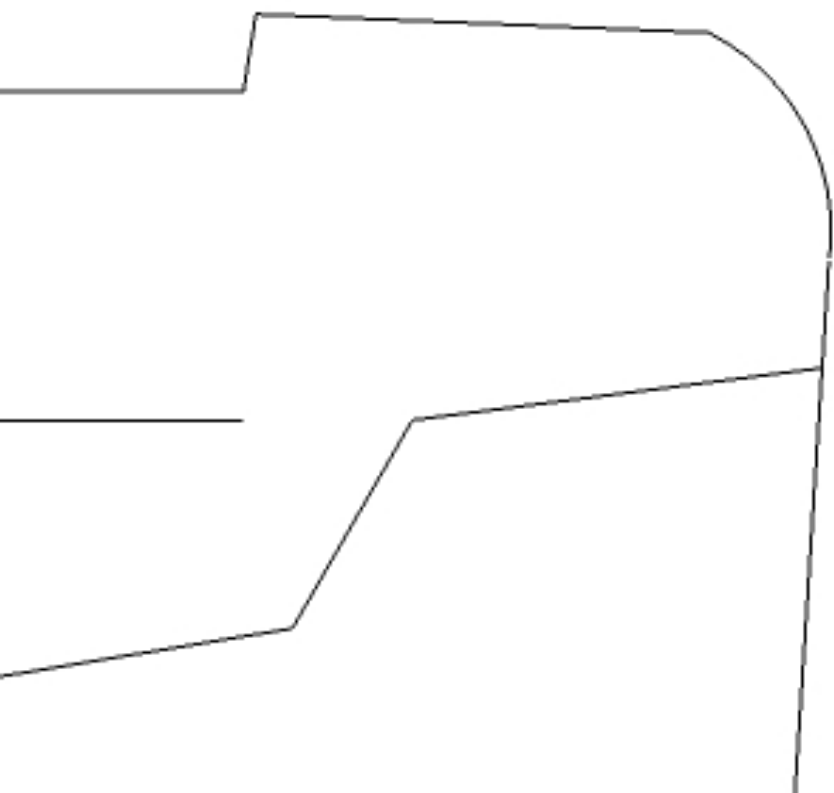
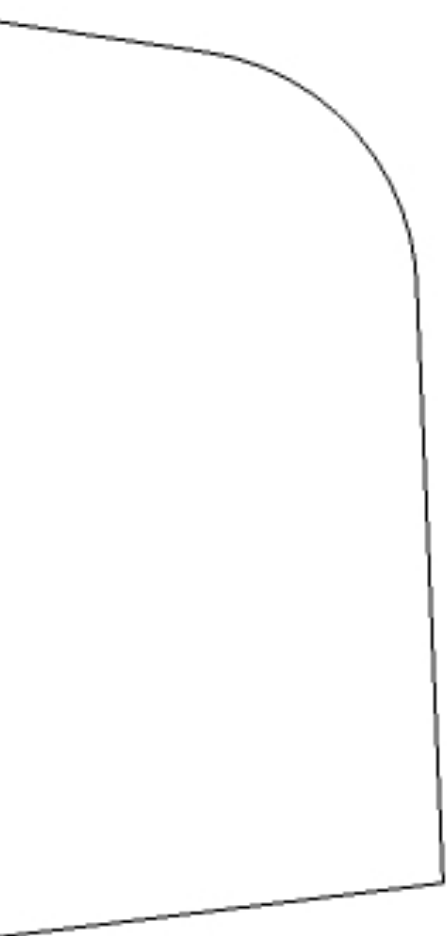

All parts 1

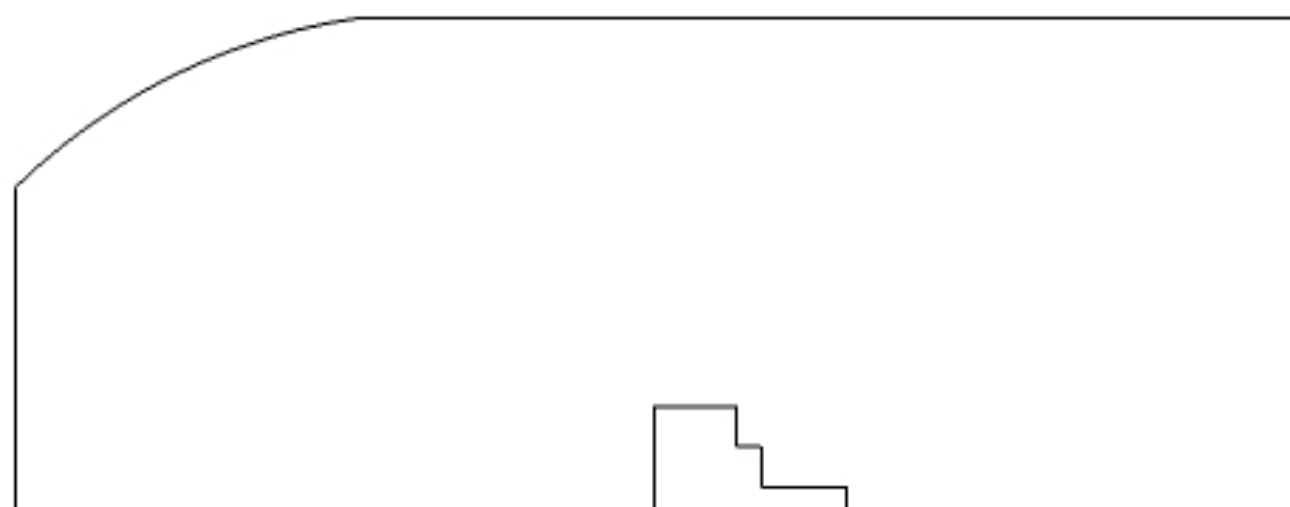
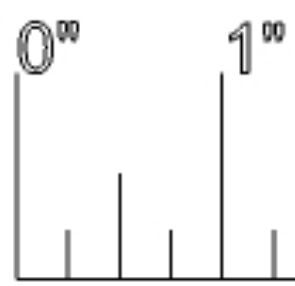
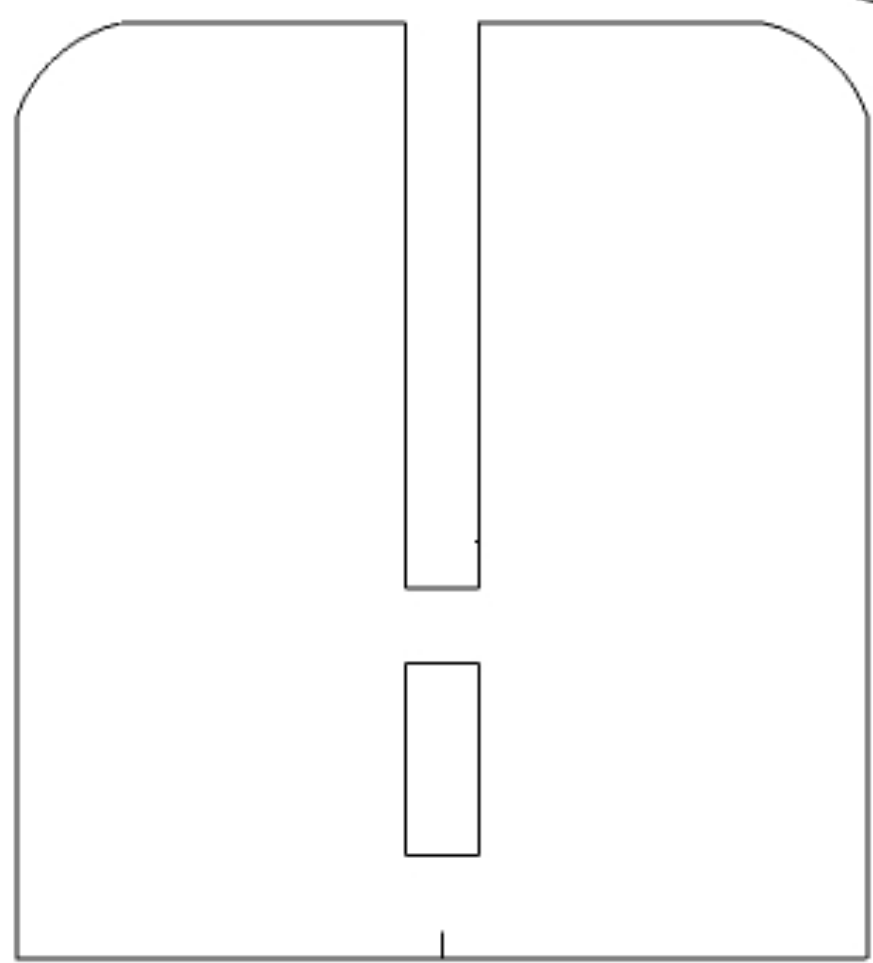

.3# 9mm EPP Foam

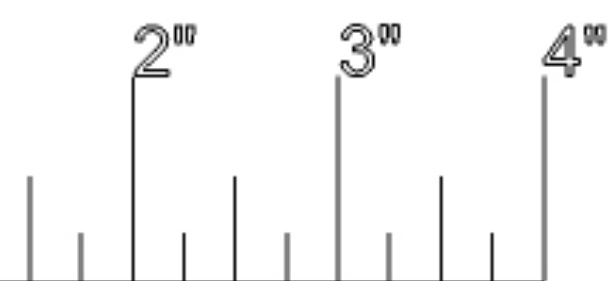

Servo cutouts

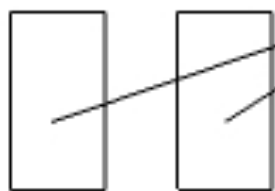

Plane Design  
Robert Viski  
[www.sdpark.com](http://www.sdpark.com)  
copyrighted



igned by:

flyers.com

2013

